

# Forest Practices Code

2000

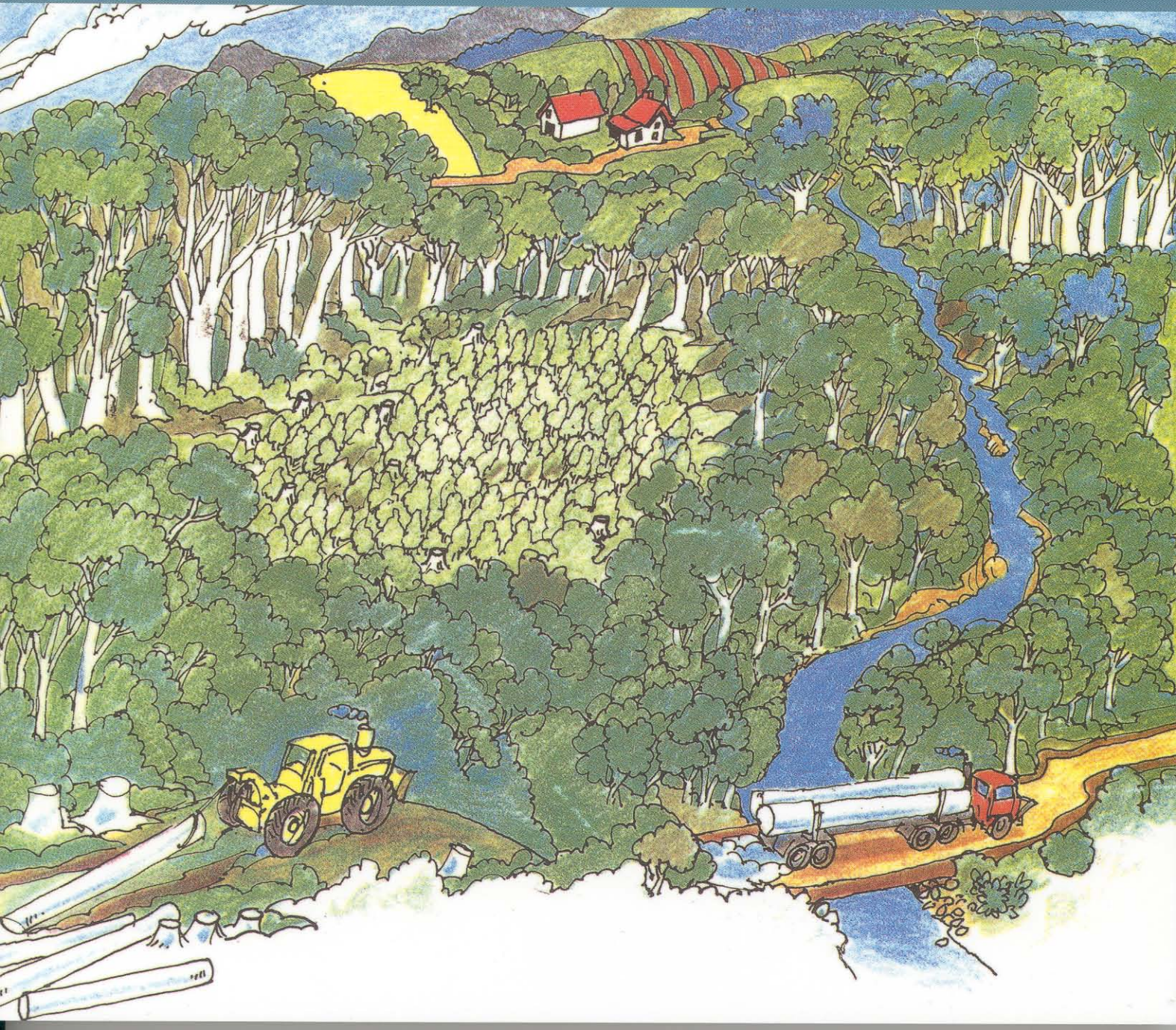

# Forest Practices Code 2000

© Forest Practices Board, Tasmania

Information in this Code may be copied for personal use or published for educational or training purposes provided that any extracts are fully acknowledged.

The preferred citation is:

Forest Practices Board (2000). Forest Practices Code, Forest Practices Board, Hobart, Tasmania.

---

published by the Forest Practices Board, 30 Patrick Street, Hobart – Tasmania – 7000  
phone (03) 6233 7966; fax (03) 6233 7954; email [info@fpb.tas.gov.au](mailto:info@fpb.tas.gov.au); [www.fpb.tas.gov.au](http://www.fpb.tas.gov.au)

ISBN 0 7246 3509 2

---

# Contents

	page
<b>A INTRODUCTION .....</b>	<b>1</b>
1 Tasmania's Forest Practices System .....	1
2 The Forest Practices Code .....	2
3 Planning .....	3
3.1 Strategic Planning .....	3
3.2 Operational Planning – Forest Practices Plans .....	3
<b>B BUILDING ACCESS TO THE FOREST .....</b>	<b>6</b>
1 Planning and Locating Roads .....	6
2 Road Design .....	8
3 Road Construction .....	12
3.1 Clearing and Formation .....	12
3.2 Road Drainage .....	14
3.3 Surfacing .....	18
3.4 Steep Country .....	18
4 Upgrading Existing Roads and Tracks .....	20
5 Quarries and Borrow Pits .....	21
6 Bridge, Causeway and Ford Construction .....	23
7 Road Maintenance .....	24
8 Water Supply and Other Significant Catchments .....	25
<b>C HARVESTING OF TIMBER .....</b>	<b>26</b>
1 Design, Planning and Equipment Considerations .....	26
1.1 Dispersed Harvesting Design .....	26
1.2 Fire Planning .....	27
1.3 Wet and Dry Season Site Selection .....	29
1.4 Extraction Equipment and Soil Protection .....	30
1.5 Felling .....	32
2 Wet Weather Limitations .....	33
3 Snig Tracks and Landings .....	35
3.1 Snig Tracks .....	35
3.2 Snig Track Restoration and Control .....	39
3.3 Landings .....	41
3.4 Landing Restoration .....	43
4 Water Quality and Watercourse Protection .....	45
4.1 Native Forest Streamside Reserves .....	45
4.2 Plantation Streamside Reserves .....	47
4.3 Swampy Ground and Surface Seepage Areas .....	48
4.4 Water Supply Catchments .....	48
5 Salvage Operations .....	49
6 Steep Country Harvesting .....	49
<b>D CONSERVATION OF NATURAL AND CULTURAL VALUES .....</b>	<b>51</b>
1 Soils .....	52
2 Water Quality and Flow .....	54
2.1 Watercourse Protection .....	55
2.2 Water Supply and Other Significant Catchments .....	57
3 Flora and Fauna .....	58
3.1 Flora Conservation .....	59
3.2 Fauna Conservation .....	61
3.3 Threatened Species and Inadequately Reserved Plant Communities .....	64
4 Landscape .....	65
4.1 Roads and Quarries .....	66
4.2 Harvesting .....	66
4.3 Plantation Development .....	69
5 Cultural Heritage .....	70

---

5.1	Planning and Assessment .....	71
5.2	Site Management .....	72
6	Geomorphology .....	72
6.1	Planning and Assessment .....	73
6.2	Site Management .....	73
<b>E ESTABLISHING AND MAINTAINING FORESTS .....</b>		<b>74</b>
1	Reforestation .....	74
1.1	Planning .....	74
1.2	Site Preparation Techniques .....	75
1.2.1	Native Forest Regeneration .....	76
1.2.2	Plantation Development .....	78
1.3	Species Selection .....	84
1.4	Stocking Standards .....	85
1.5	Protection from Grazing and Browsing .....	87
1.6	Fire Breaks and Access Tracks .....	88
2	Use of Chemicals .....	89
3	Fire Management.....	91
3.1	Fire Management Plans .....	91
3.2	Forest Practices Plans .....	91
3.3	Burning .....	92
4	Pest, Disease, and Weed Control.....	92
4.1	Insect Pests .....	92
4.2	Diseases .....	93
4.3	Weeds .....	93
5	Thinning .....	93
<b>F MANAGEMENT OF FUEL, OILS, RUBBISH AND EMISSIONS .....</b>		<b>94</b>
1	Use of Fuel, Grease and Oils.....	94
2	Disposal of Rubbish.....	95
3	Smoke, Noise and Dust .....	95
<b>G GLOSSARY .....</b>		<b>96</b>
<b>H REFERENCES .....</b>		<b>102</b>
<b>I SELECTED BIBLIOGRAPHY .....</b>		<b>104</b>
<b>APPENDIX 1</b>		
	Protocol for Forestry Field Marking Colours .....	105
<b>APPENDIX 2</b>		
	Town Water Supply and Freshwater Aquaculture Facility Intakes .....	107
<b>APPENDIX 3</b>		
	A Guide for Operations on Very High Erodibility Class Soils .....	111
<b>APPENDIX 4</b>		
	A Guide for Operations on Soils with High or Very High Erodibility by Wind .....	115
<b>APPENDIX 5</b>		
	A Field Test for Assessing Soil Water Status .....	117

---

## **APPENDIX 6**

An Outline of Soil Erodibility Classes in Relation to Soil Properties .....	118
---	-----

## **APPENDIX 7**

Slope Angles in Degrees and Percent .....	120
---	-----

## **INDEX TO TABLES**

Table 1	A Guide to Road Design Based on Average Tonnes Per Week Carted .....	8
Table 2	Maximum Spacing between Table Drain Outlets or Culverts for Forest Roads .....	10
Table 3	Wet or Dry Season Harvesting Criteria .....	29
Table 4	Approximate Static Ground Pressures for Harvesting Machinery Classes .....	30
Table 5	Harvesting Machinery Guide .....	32
Table 6	Maximum Spacing between Cross Drains on Snig Tracks .....	40
Table 7	Landslide Threshold Slope Angles .....	54
Table 8	Minimum Streamside Reserve Widths or Machinery Exclusion Zones .....	56
Table 9	Reforestation Technique Guide .....	76
Table 10	Windrowing, Mounding and Catch Drain Spacing for Different Slope and Soil Erodibility Classes .....	79

---

## A. INTRODUCTION

### A1. Tasmania's Forest Practices System

Tasmania is endowed with extensive forest resources. These forests contain natural, cultural and economic values which will be managed in a sustainable manner to optimise the benefit to current and future generations.

Good forest management entails protection of natural and cultural values during forest operations, and proper reforestation where areas are to be reforested. The *Forest Practices Act 1985* was passed to ensure that forest operations are conducted in an environmentally acceptable manner on public and private forest lands. The Act forms part of a broader legislative and policy framework that provides the basis for sustainable forest management in Tasmania.

The statutory objective of the forest practices system is to:

*achieve sustainable management of Crown and private forests with due care for the environment while delivering, in a way that is as far as possible self-funding -*

*(a) an emphasis on self-regulation; and*

*(b) planning before forest operations; and*

*(c) delegated and decentralized approvals for forest practices plans and other forest practices matters; and*

*(d) a forest practices code which provides practical standards for forest management, timber harvesting and other forest operations; and*

*(e) an emphasis on consultation and education; and*

*(f) provision for the rehabilitation of land in cases where the forest practices code is contravened; and*

*(g) an independent appeal process; and*

*(h) through the declaration of private timber reserves - a means by which private land holders are able to ensure the security of their forest resources.*

The *Forest Practices Act 1985* provides for the administration of the forest practices system through the Forest Practices Board. The statutory objective of the Board is to:

*act in all matters in a manner that-*

*a) best advances the objective of the State's forest practices system; and*

*b) fosters a co-operative approach toward policy development and management in forest practices matters.*

The Act also provides for a Forest Practices Advisory Council to provide expert advice to the Board and to foster communication and cooperation among stakeholders. Various stakeholders with expertise in forest management on public and private land, forest harvesting, forest conservation and Tasmania's resource management and planning system are represented on the Council.

The Board appoints Forest Practices Officers who are responsible for planning, monitoring and certifying that Forest Practices Plans are prepared and implemented in accordance with the Forest Practices Code and any instructions issued by the Board. Forest Practices Officers are also responsible for taking corrective action and enforcing the Act as necessary to ensure compliance in operations under their control. The Chief Forest Practices Officer is responsible for the day to day administration of the forest practices system. Specialists are employed by the Board to conduct research and provide practical management advice to Forest Practices Officers on the conservation of natural and cultural values.

Forest operations are covered by Forest Practices Plans that are prepared in accordance with the Forest Practices Code. The Forest Practices Regulations provide exemptions for small scale operations. The Act also contains compliance requirements in relation to monitoring and reporting upon Plans, the Code and other provisions of the Act. The Forest Practices Board conducts independent audits of compliance, and the results are publicly reported in the Board's Annual Report to Parliament. The Board is also required to take action with respect to offences under the Act.

## A2. The Forest Practices Code

The *Forest Practices Act 1985* provides that the Forest Practices Code shall prescribe the manner in which forest practices are to be conducted so as to provide reasonable protection to the environment. The Code is issued by the Forest Practices Board, after extensive consultation and public comment.

The Code provides a practical set of guidelines and standards for the protection of environmental values during forest operations, in particular:

- soils
- geomorphology
- visual landscape
- water quality and flow
- flora, fauna, genetic resources
- cultural heritage

The Code does not directly deal with utilisation standards or occupational health and safety, as these matters are addressed within other legislative and policy frameworks.

The Forest Practices Code contains both 'General Principles' and the 'Basic Approach' for particular forest practices. In the 'Basic Approach' sections of the Code there are two different types of statements: the 'will' and 'should' statements. The 'will' statements are to be applied in a practical manner to forest operations covered by the *Forest Practices Act*. The 'should' statements show the desirable practice for most situations and are to be interpreted by a Forest Practices Officer taking account of local conditions. 'Should' statements will be applied unless there are good reasons for making exceptions, and acceptable environmental outcomes are achieved. In most cases, the Code provides the minimum standards that are to be achieved. In certain cases further protection of particular environmental values may be required and appropriate measures will be specified in Forest Practices Plans.

Sketches have been used throughout the Code to assist readers in understanding the basic approach. The sketches are indicative only and alternative approaches may be desirable in specific circumstances.

References to other documents have been used in the Code where considered appropriate. These are shown in italics and given a sequential number (e.g. *Quarry Code of Practice*<sup>2</sup>) which corresponds to the reference number in Section H.

The Code is supported by other manuals and technical instructions that are endorsed from time to time by the Forest Practices Board after consultation with the Forest Practices Advisory Council. Forest Practices Officers will use these documents and follow instructions issued by the Board.

The Code contains policies and practices which have been developed as a result of ongoing research and practical experience. Research and innovation by landowners, contractors and the forest industry is encouraged. The Code is kept under regular review and the results of research, field experience and public input are used to make progressive improvements so that environmentally sound, socially responsible and economically acceptable production forestry can be maintained.

The first Forest Practices Code became operational in November 1987, and was extensively reviewed and revised in 1993. The latest version takes into account the results of experience, research, independent reviews and submissions received from the general public, landowners, scientists, unions, contractors, conservationists, and land and resource managers from industry and government.

## **A3 Planning**

### **A3.1 Strategic Planning**

#### **General Principles**

- The legislative and policy framework within Tasmania provides a comprehensive basis for strategic and operational planning. Strategic planning is undertaken on the basis of processes such as:
  - The Tasmanian Regional Forest Agreement and Forests and Forest Industry Strategy;
  - Forest Management Plans and Management Decision Classification zoning on State forests;
  - Forest Management Plans and Private Timber Reserves on private land;
  - Three Year Plans prepared for State forests and private forests under the provisions of the *Forest Practices Act 1985*.
- Proper planning at both the strategic and operational level reduces environmental impact and operational costs.

### **A3.2 Operational Planning - Forest Practices Plans**

#### **General Principles**

- Operational planning is carried out on the basis of Forest Practices Plans and associated plans such as burning plans.
- Forest practices will be conducted according to a certified Forest Practices Plan based on the provisions of this Code. Exemptions for small scale operations are specified in the Forest Practices Regulations.
- Soils, water quality and flow, air quality, site productivity, biodiversity, landscape, cultural heritage and landforms are potentially affected by forest operations and will be considered at the planning stage. Specialists are available to provide advice to land managers and Forest Practices Officers.
- The environmental effects of all forest operations envisaged for an area including access, harvesting, restoration, reforestation where applicable and maintenance, will be considered before operations start.
- Planning will involve the collection of site information and consultation with relevant persons and organisations.
- The information gathered during planning will be the basis for the Forest Practices Plan. A well thought out and prepared Forest Practices Plan is the key to good forest practices.



## Basic Approach

- Forest Practices Plans are required for the following activities:
  - the establishment of forests;
  - the harvesting of timber;
  - the construction of a road or the operation of a quarry in connection with the establishment of forests or the harvesting of timber.
- A Forest Practices Plan can be very simple or complex, depending on the site. When drawing up a Forest Practices Plan the following factors will be considered, and appropriate provisions will be included in the Plan regarding:
  - Location and land ownership, with any legal covenants noted.
  - Whether the land is dedicated as a Private Timber Reserve.
  - Period of planned operations.
  - Basic features of the area:
    - topography, geology, soil type, erodibility and landslide potential;
    - rainfall and drainage characteristics, including watercourse classifications;
    - type of forest;
    - existing access.
  - Management requirements to ensure adequate protection of values such as soils, water, flora, fauna, apiary resources, geomorphology, cultural heritage, and visual landscape (see Section D).
  - Management objectives including harvesting prescriptions and reforestation prescriptions where the landowner wishes to restock with trees.
  - Measures to ensure efficient timber harvesting and sustain site productivity:
    - additional access or improvements to existing access, i.e. roads and bridges;
    - harvesting methods, i.e. wet and dry season harvesting areas, landings, snigging pattern;
    - restoration following harvesting.
  - How any boundaries or other features are to be delineated in the field. Appendix 1 shows the standard marking colours recommended for field use.
  - Maintenance and protection of the forest including fire management, pest, disease and weed control.
  - For a quarry, details regarding establishment, management and planned rehabilitation.
  - Local government planning schemes, where applicable.
  - The potential off-site impact of plantation development on adjoining land will be considered and reasonable measures will be taken to address issues such as:
    - shading of residences;
    - adverse effects on crops;
    - safety;
    - pest and weed control;
    - fire protection;
    - potential effects on adjacent conservation reserves.

- Consultation with local government will occur prior to certification of Forest Practices Plans involving:
  - areas with landscape protection provisions in planning schemes;
  - operations which potentially affect water quality in a listed town water supply catchment (see Appendix 2);
  - operations within 2 km upstream of a town water supply intake;
  - construction of new access or major upgrading of existing access for timber harvesting onto local government roads.
- Notification with respect to planned forest practices will be provided to local government and to landholders within 100 m of the boundary of the planned practices. The objective is to encourage effective communication and consultation with respect to proposed forest operations. The details in relation to the practices should be provided at least 30 days prior to the commencement of the operations.
- Forest Practices Plans will be certified by an authorised Forest Practices Officer prior to the commencement of operations and at the completion of operations. Forest Practices Plans will comply with this Code and with all instructions issued by the Forest Practices Board.
- Relevant information within Forest Practices Plans should be made available to interested parties in an effective and efficient manner.
- All provisions within Forest Practices Plans will be consistent with safe working practices. Persons carrying out operations under a Plan will also comply with all other relevant laws, including the conditions of any licences, permits and other authorities issued.

EXAMPLE OF A FOREST PRACTICES PLAN MAP.

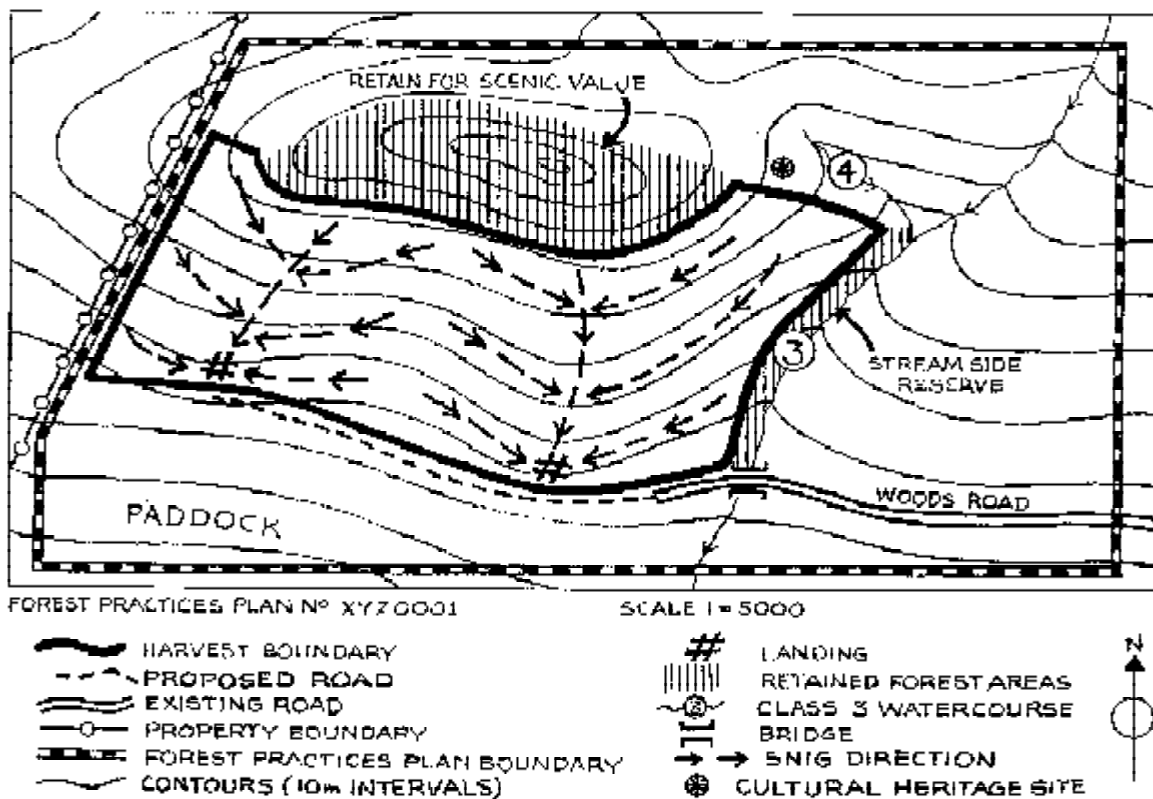

## B. BUILDING ACCESS TO THE FOREST

### B1. Planning and Locating Roads

#### General Principles

- Adopt the design standard that ensures the road will carry the anticipated traffic with safety.
- Fit the road to the topography so that a minimum of alterations to the natural features will occur. Use ridgetop roading where applicable. Midslope roads should be avoided as much as possible in steep country.
- Ascertain the presence of significant unstable areas and of natural and cultural values by using local knowledge and consulting:
  - Table 7, Landslide Threshold Slope Angles (page 54);
  - Appendix 3 - A Guide for Operations on Very High Erodibility Class Soils (page 111);
  - Appendix 4 – A Guide for Operations on Soils with High or Very High Erodibility by Wind (page 115);
  - Section D – Conservation of Natural and Cultural Values (page 51);
  - Resource Manuals or other sources (pages 102-104);
  - Specialists.
- Avoid road locations in steep narrow valleys, swamps, slip prone or other unstable areas, very highly erodible soils, natural drainage channels, streamside reserves and areas where roading would substantially affect significant other values.
- Roads are a potential source of watercourse sedimentation and turbidity. Road design, construction and maintenance will aim to minimise that potential.
- Minimise the number of watercourse crossings.
- Plan harvesting roads to minimise the sum of snigging and road construction impacts.
- Minimise soil exposure to lessen the potential for erosion.
- Plan for dry season construction.
- Allow for the proper consolidation of the roads before carting, particularly roads to be used for wet weather carting.
- Carefully consider the use of appropriate equipment, make sure operators know what is required and ensure proper supervision.

#### Basic Approach

- The landowner or nominee will obtain written approval from the Department of Infrastructure, Energy and Resources for the construction of new road access or major upgrading of existing road access onto State highways before a Forest Practices Plan will be certified.
- Local government will be consulted where construction of new or substantial upgrading of existing access onto municipal roads is required.

- Where other important values or unstable areas are known to be present, surveys or hazard mapping should be done to assist in the location or relocation of the roads.
- Roads will be located on natural benches (provided they are not backslopes of old landslides), ridge tops and flatter slopes, wherever topography permits. Special measures are required if roads are to be built on very high erodibility class soils (see Appendix 3), or on soils of high or very high erodibility by wind (see Appendix 4).

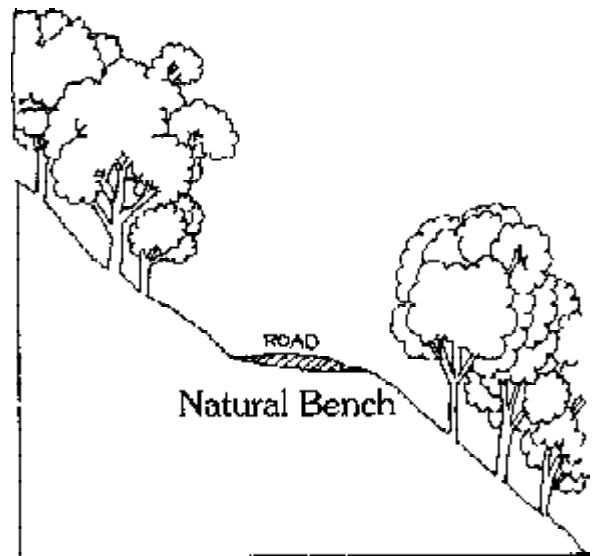

- Roads will be located to avoid caves, sinkholes, streamsinks and springs. Swamps will be avoided where practicable.
- Rocky or exposed knolls should be avoided, as they may be important for rare or inadequately reserved vegetation, or be visually sensitive.
- Before coupe road location is finalised, consultation with stakeholders should occur to ensure that adequate provision has been made for safe landing sites, including reasonably level truck loading bays.
- Interference to natural drainage will be minimised.
- Watercourse crossings should be at right angles to the watercourse.

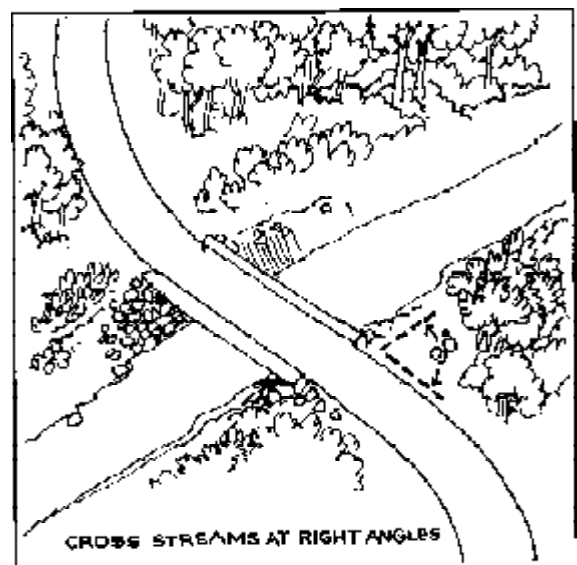

- Roads constructed parallel to a watercourse should be at least 100 m from a Class 1 and 2 watercourse and 40 m from all other watercourses. (See Table 8, page 56 for definitions of watercourses.)

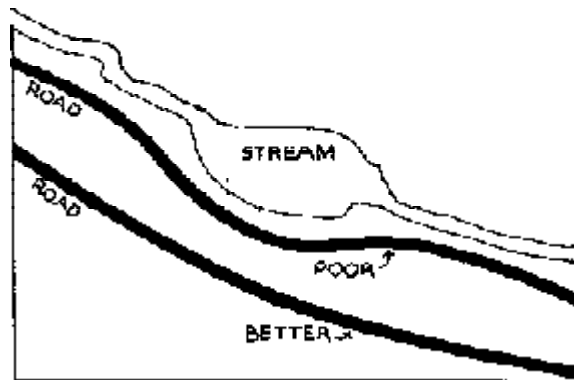

## B2. Road Design

### Basic Approach

**Table 1. A Guide to Road Design Based on Average Tonnes Per Week Carted**

Function	Class 1 Road Primary road in large network	Class 2 Road Significant feeder road	Class 3 Road Minor (spur) road	Class 4 Road Minor (spur) road	Access Track Temporary track
Log Traffic Volume (tonnes/week)	2500	1000-2500	1000	Up to 1000	Short term use
Pavement Type	Surfaced, all weather	Surfaced, all weather	Surfaced, all weather	All weather or unsurfaced	Dry weather cartage only, unsurfaced
Pavement Width	5.5-6.0 m	5.5 m	3.7-4.0 m	3.7 m	3.0-3.7 m
Shoulder Width	0.6-1.0 m	0.6 m	0.5 m -1.0 m	0.6 m	
Desired Max. Gradients	+5%, -8%	+8%, -10%	+12%, -15%	+15%, -15%	+15%, -15%
<b>Note:</b> The above road design specifications are appropriate for tri-axle log trailers. Truck configurations such as B-doubles may require different specifications.					

- Roads will be fully drained with bridges, culverts, table drains, or other drainage structures as required.
- Access tracks will be drained at intervals as per Table 2, page 10 using spoon drains or cross fall drainage; or may be fully drained if intended for future upgrading. Water will be drained off access tracks during the last 20 m before any watercourse crossing into sediment traps or vegetation by use of cross fall drainage or water bars.

- Access tracks not required for carting may cross watercourses at natural crossing points without the use of drainage structures provided disturbance to the watercourse beds and banks is minimised. The number of these crossings will be kept to the absolute minimum required for access.
- Access tracks within coupes and across previously cleared ground (e.g. paddocks) can be used for carting provided such tracks are effectively drained during use (e.g. using spoon drains or outsloping) and are used for dry weather carting only. These tracks will be restored or revegetated on completion of harvesting if no longer required, using the same standards as required for snig tracks (see page 40). They will be restored with spoon drains and/or outsloped if required for future access.
- Cuts and fills should be balanced along the road, so that as much of the excavated material as is practicable can be deposited in the roadway fill sections.

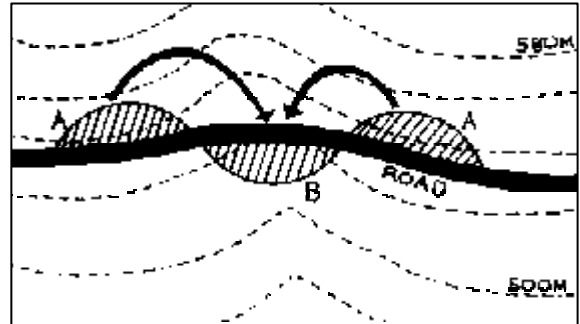

- When it is unavoidable to construct roads across unstable sites such as slip zones, roads will be designed so that water does not accumulate on the slip and excess material will not be dumped on the slip zone.
- Step approaches to bridges should be avoided.
- Batter slopes will be designed to be stable, balancing the risk of massive slumping and surface erosion through rilling, and taking soil type into account.
- Batter slopes on very high erodibility class soils will be managed according to Appendix 3.
- Drainage design should account for the likely increased run off after clearfelling.

- Culverts draining roads should be located so that discharge filters through undisturbed forest vegetation.

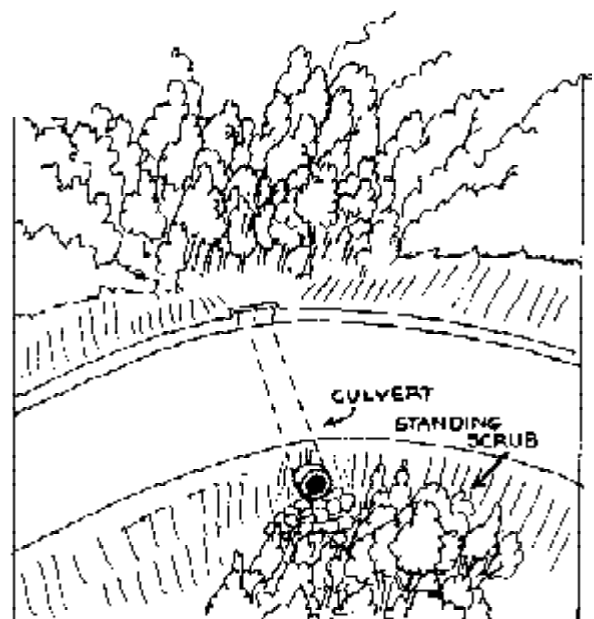

- The following table should be applied to the spacing of road drain outlets or culverts.

**Table 2. Maximum Spacing between Table Drain Outlets or Culverts for Forest Roads**

Road Grade	Soil Erodibility Class		
	Low to Moderate	Moderate-High to High	Very High
1-5%	150 m	120 m	70 m
6-10%	120 m	90 m	40 m
11-15%	95 m	70 m	30 m
16-20%	50 m	35 m	30 m

**Note:**

Where large water flows are anticipated (e.g. after windrowing or site cultivation in plantation establishment) the distance between discharge points in table drains should be reduced and/or the drain profile enlarged.

See page 52 for soil erodibility classes, and page 19 for culvert spacing on steep country midslope roads.

Culverts should be located so as to not compromise potential landing sites where these are limited.

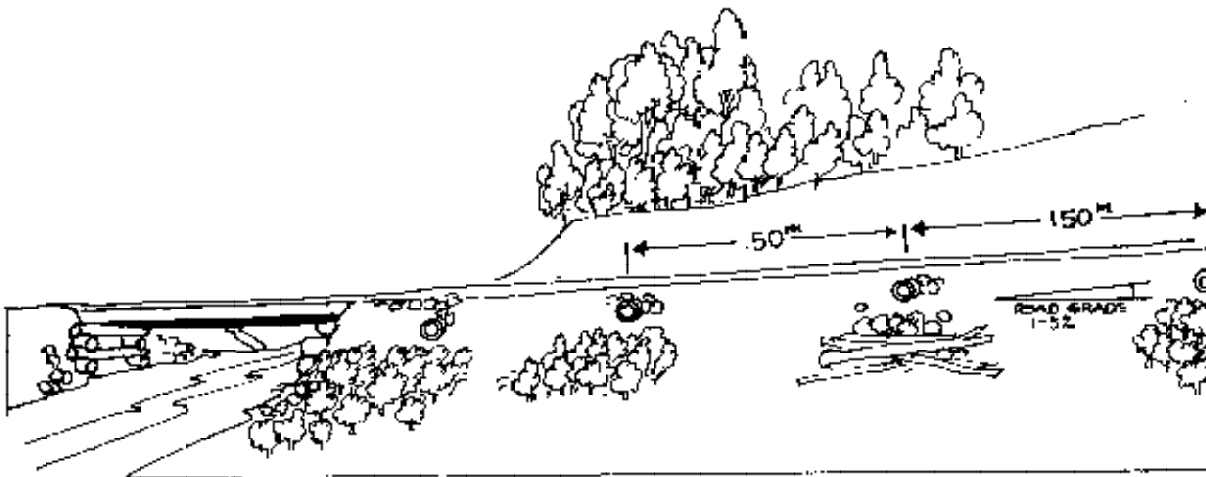

- The minimum diameter of culvert pipes should be 300 mm. The optimum size will depend on local knowledge of climate and conditions. In the following situations where the risk of culvert blockage or consequence of failure is high, the minimum diameter of culvert pipes will be 375 mm unless otherwise specified by a Forest Practices Officer:
  - areas subject to high intensity rainfall events e.g. parts of eastern Tasmania;
  - areas with high or very high erodibility class soils;
  - midslope roads in steep country.

- New drainage structures with openings of greater than 1 m<sup>2</sup> should be designed to withstand the following floods (but see also Section B6, page 23). If not, the surfacing material will be removed prior to the expiry of the relevant Forest Practices Plan.

<u>Road Class</u>	<u>Calculated Flood Recurrence Interval</u>
1	1 in 50 year
2	1 in 20 year
3, 4	1 in 10 year

- In addition the design should provide that the top of the inlets should not be submerged in peak flows by more than 0.5 m in low to moderate-high erodibility class soils or 0.1 m in high to very high erodibility class soils unless specific measures are undertaken to protect against erosion where the water discharges at the downstream end.

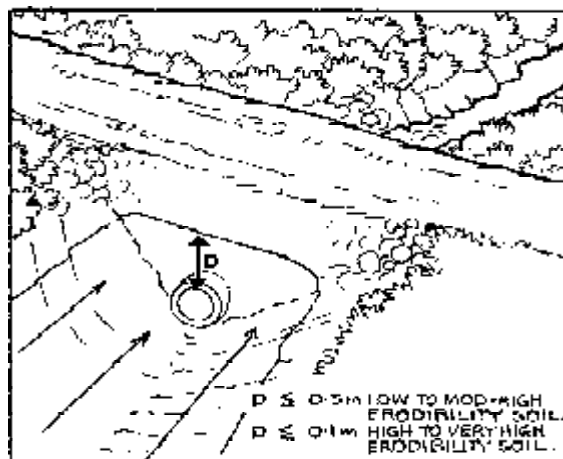

- See also page 15 for design and installation requirements to facilitate passage of aquatic fauna.
- The Rational method <sup>1</sup> is recommended for calculating the culvert size or opening required for watercourse crossings.
- Culvert pipes should be of reinforced concrete or alternative material of sufficient strength to handle anticipated bearing loads.
- In low to moderate erodibility class soils Class 4 watercourses close to one another can be serviced by a single culvert provided scouring of table drains, inlets and outlets is unlikely to occur.

### ***Steep Country (Slopes 20° and Above)***

- Single lane roads and a lower standard of both horizontal and vertical alignment should be used where practicable to minimise the extent of the earthworks and visual impact.
- On slopes of 24° or above roads will be designed to a stage so the extent of the earthworks can be identified and approved by a Forest Practices Officer prior to construction. However, if the Forest Practices Officer is convinced from field inspection that there will be no undue visual, road stability or environmental consequences, the road may be approved without full design.
- Design major culverts and drainage structures to carry the 50 year flood.



## B3 Road Construction

### B3.1 Clearing and Formation

#### Basic Approach

- Roadlines should be logged out during or before road construction, and timber salvaged during or soon after construction. All trees pushed or felled should be left so as to ensure that the timber can be recovered in a safe manner.

- Road clearing will be of minimum width to reduce the extent of soil disturbance, particularly within streamside reserves, but sufficient trees should be removed to allow the road to dry and to provide adequate line of sight.

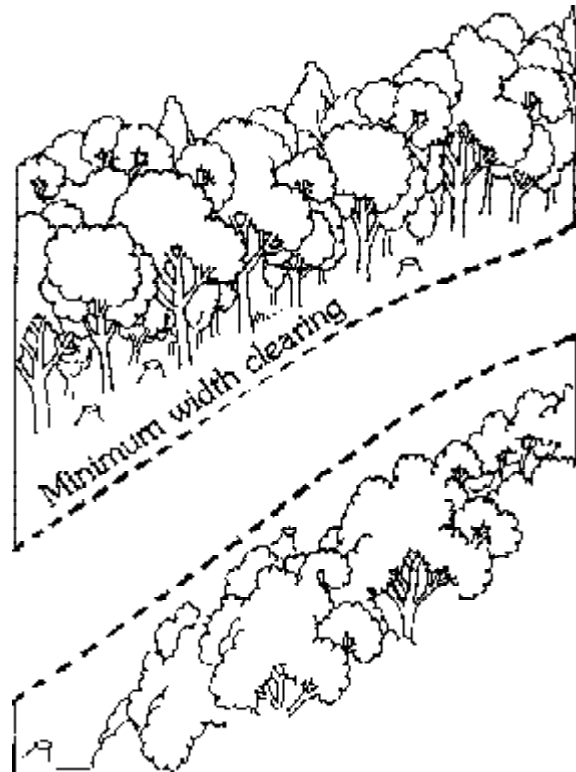

- Where a road passes through a streamside reserve, clearing of vegetation should be minimised and trees felled parallel to the road and away from the watercourse wherever possible.
- Hazardous trees which have a significant probability of falling onto the road surface should be removed during construction. Where a hazardous tree is located in a reserve prior approval from a Forest Practices Officer will be obtained before it is removed.
- Stripping of topsoil outside road construction limits will be minimised.

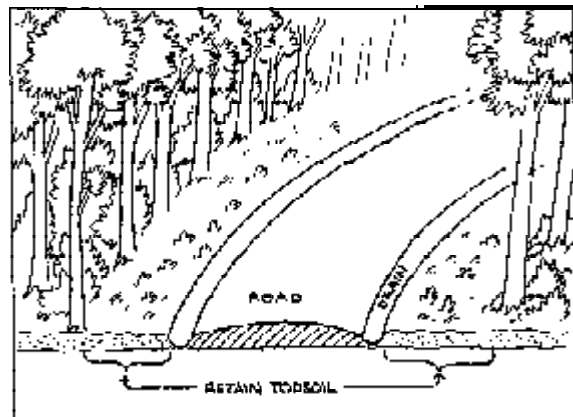

- Where practicable, stripped topsoil should be stockpiled in suitable accessible locations for future use on batter slopes, borrow pits, quarries and landings associated with the road, or be used immediately for these purposes.
- Material stripped from the road alignment will be disposed of or stockpiled in such a way as not to impede drainage.
- Structural fill should not be placed on soil heaps or timber debris.
- In critical areas, such as water catchments close to town water supply intakes, known or predicted localities of threatened aquatic fauna, and areas of important karst drainage and swamps, surplus fill will be transported away or otherwise contained to minimise disturbance within streamside reserves.
- Fills will be contained so that fill material does not enter sinkholes in karst areas.
- Where road construction through landslip prone areas cannot be avoided vegetation should be retained permanently for some distance upslope.

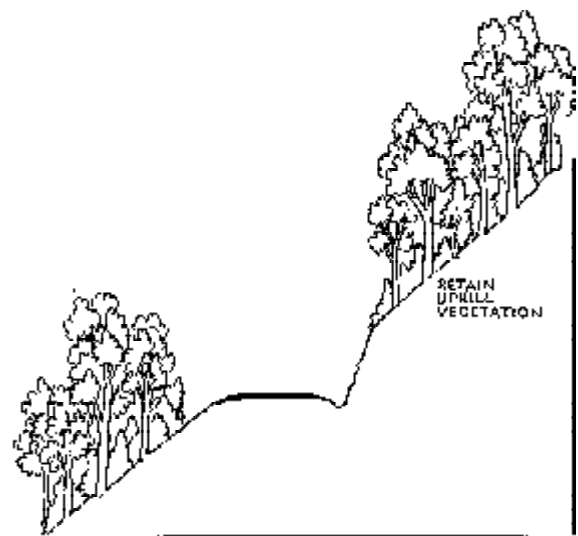

- Where roads are constructed through areas containing myrtle, myrtle wilt disease is a risk. Machine and falling damage to the adjacent myrtle stands and heaping of debris into the undisturbed myrtle area should be avoided. Where practicable, live myrtle trees inadvertently damaged during construction should be removed. Measures should be implemented to avoid the spread of other diseases and weeds, as detailed in Section E4.
- Benching of cut batters should be considered to reduce the amount of debris falling onto the road or to improve visibility.
- If severe batter erosion is likely to occur or has occurred, batters will be treated by soil stabilising methods e.g. respreading of topsoil, revegetating or spraying with emulsions.

## B3.2 Road Drainage

### Basic Approach

- In all phases of construction, adequate drainage will be provided to achieve the stability of the road structure. Wherever practicable, permanent drainage should be installed in advance of other construction to keep the works as dry as possible. Temporary drainage will be provided where there is likely to be a significant delay in installing permanent drainage.
- Drainage will not be concentrated into sinkholes and vegetation will be retained on the margins of sinkholes.
- Where high water flow velocities are expected in high and very high erodibility class soils, drains may require special treatment such as lining with stones, concrete, grass etc. to reduce scouring.
- Where unacceptable erosion of a road cutting face is likely, catch drains should be constructed along the top sides of the cuttings to collect surface runoff. Such drains should be gently graded and/or protected against scouring, particularly in the more erodible soils.

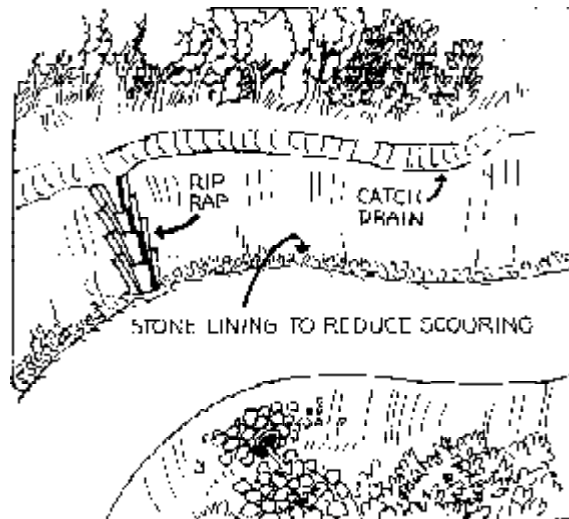

- Table drains should be constructed to a minimum depth of 300 mm below the level of the top of the formation at the outer edge of the shoulder.
- Adequate provision will be made at culvert inlets (e.g. rock-lined or concrete sumps) and outlets (e.g. energy dissipaters) to minimise erosion being caused by flow entering or discharging from the drain.

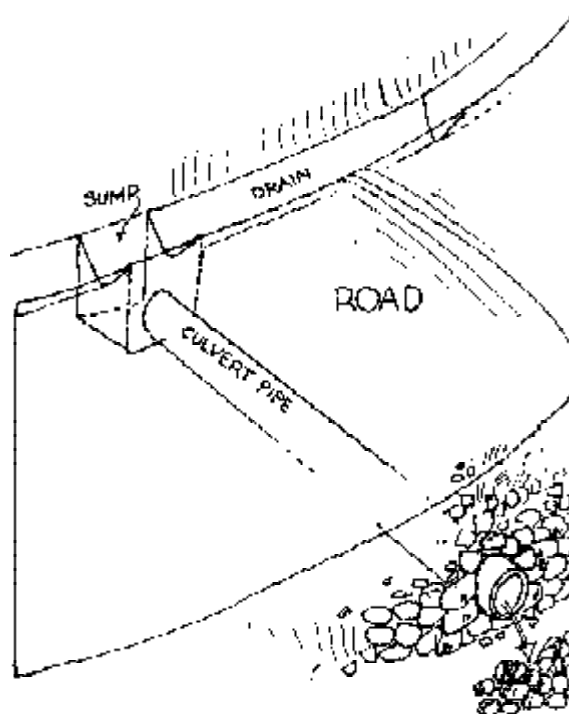

- Culvert outlets on watercourses should be protected by energy dissipaters such as large rock where natural watercourse beds downstream do not provide sufficient protection against bed scour or erosion. Care should be taken to ensure that dissipaters do not themselves cause or enhance bank or bed erosion or inhibit fish passage.

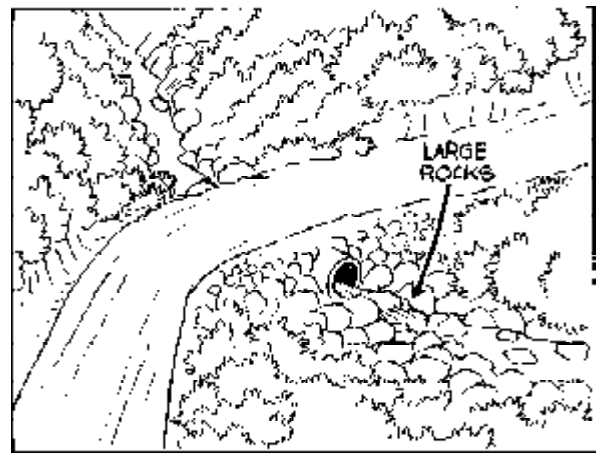

- Adequate provision of sumps or silt traps will be made to prevent siltation and blocking of culverts in high and very high erodibility class soils.
- Culvert pipes should be laid on a grade of between  $\frac{1}{2}^\circ$  and  $2^\circ$  to minimise silting up of the pipes and excessive scouring at the discharge end.
- The installation of and minimum cover over culvert pipes should be in accordance with manufacturers guidelines e.g. 600 mm for reinforced concrete pipe.

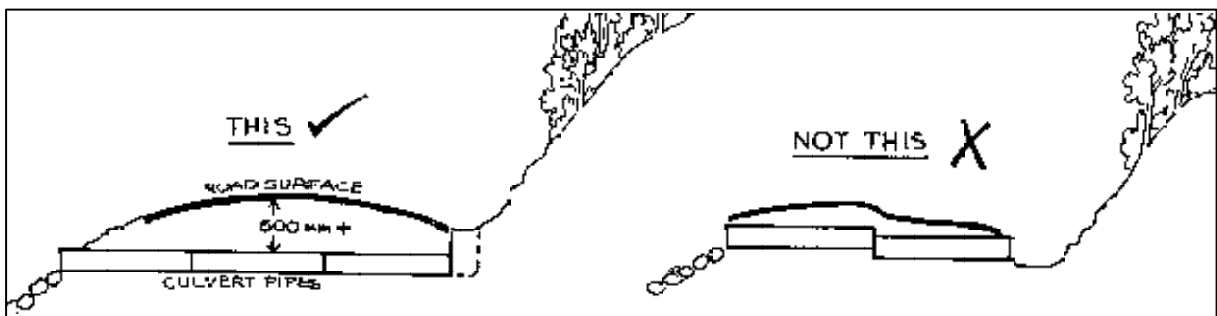

- New watercourse crossings will be designed and maintained to minimise disturbance to the passage of fish and other aquatic fauna. Consider replacement of existing crossings which are identified as resulting in fragmentation of aquatic habitats. Specialist advice should be sought.
- Special prescriptions relating to culvert placement and design may be required for watercourses containing threatened aquatic species.
- Culvert pipes should be set at or marginally below the level of the natural watercourse bed to facilitate passage of aquatic fauna.

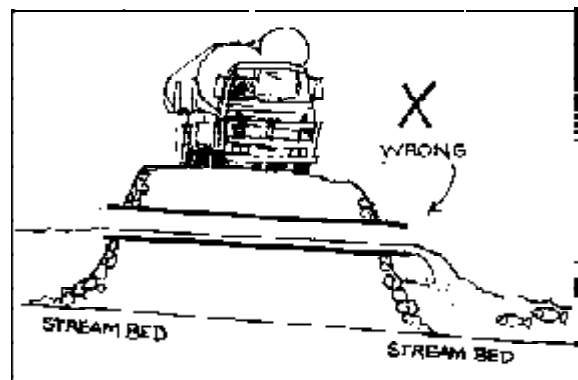
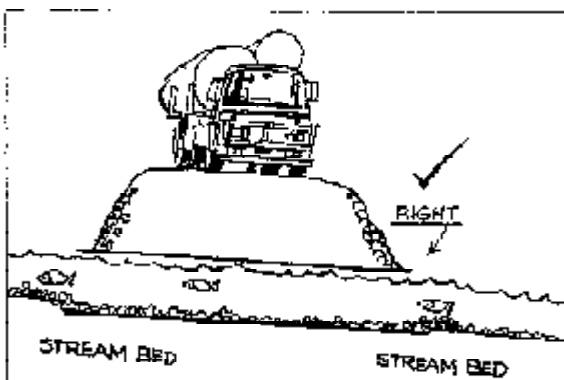

- Sediment traps of logs, rocks, straw bales, etc. will be required in places where high flows of water are expected on high and very high erodibility class soils, and should be considered in other sensitive sites or in areas to be windrowed or cultivated. Straw bale traps will require maintenance and should be periodically replaced when saturated with sediment.

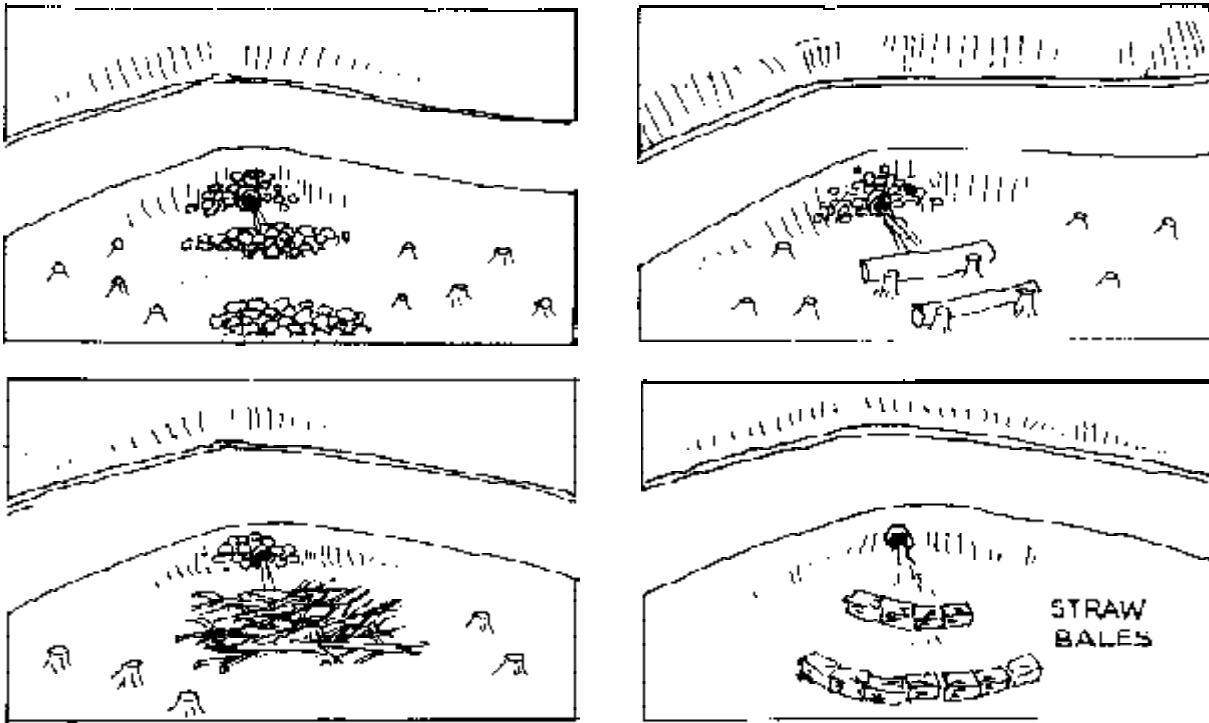

- Culverts will not discharge over fills without adequate protection.

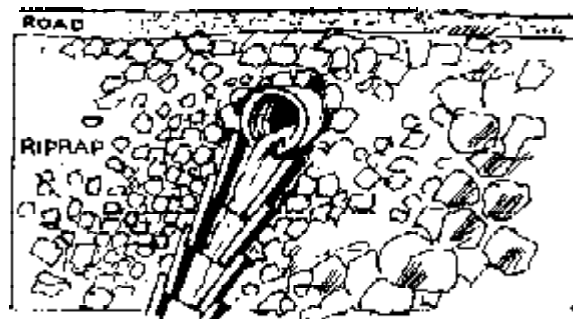

- During the last 50 m before a road crosses a watercourse:
  - where practicable road drainage flowing toward the watercourse will be diverted from table drains directly into the surrounding vegetation before entering the watercourse;
  - where not practicable, drainage diversion into the surrounding vegetation by means of a culvert should be considered for Class 4 watercourses and will be undertaken for Class 1, 2 and 3 watercourses (including surface karst channels that may usually be dry);
  - drainage diversion (as referred to above) should be as close as possible to the watercourse while maintaining an effective filter strip (one which ideally allows a minimum of 30 m of drainage over vegetated ground before entering the watercourse);
  - construction of silt traps in table drains should be considered where large silt input to watercourses would otherwise occur from table drain, batter or upslope erosion.

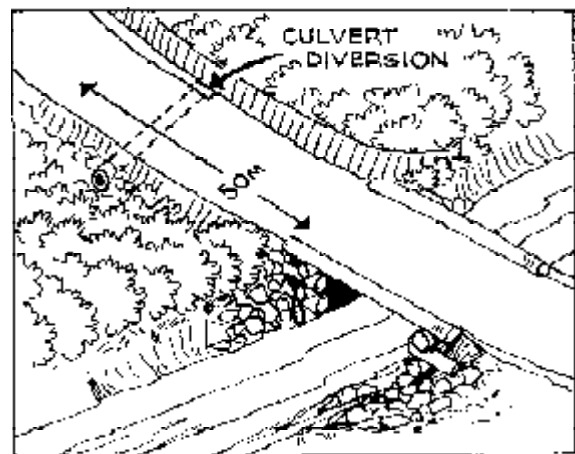
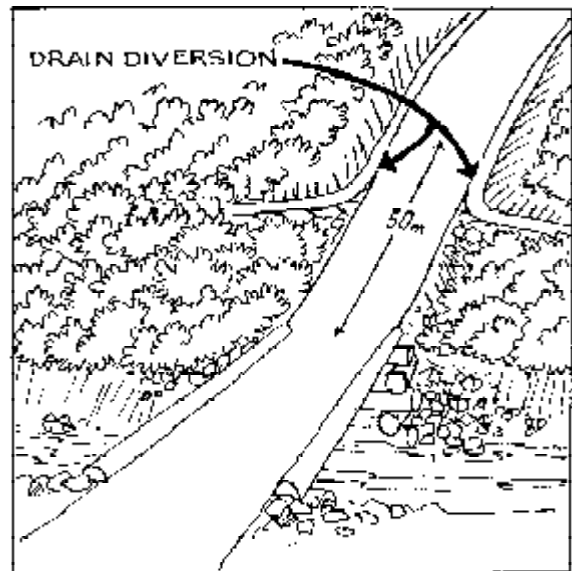

- Keep machines out of watercourses unless absolutely necessary and then keep activity in the watercourse to the absolute minimum.
- Watercourse crossings will be constructed to result in minimum disturbance to banks and existing channels.
- Temporary watercourse crossings (see Glossary) will be permitted only over Class 3 and 4 and dry Class 2 watercourses where the construction method provides a designed opening for water passage (e.g. log culvert, see diagram next page), or where intended for road construction access.

- Temporary watercourse crossings will be either:
  - removed with minimal disturbance to the watercourse prior to the termination of the relevant Forest Practices Plan, and resulting road or track ends water barred to divert the road or track drainage into surrounding vegetation; or,
  - upgraded to the standard for Class 3 or 4 road permanent watercourse crossings. Any potential erosion points will be stabilised.

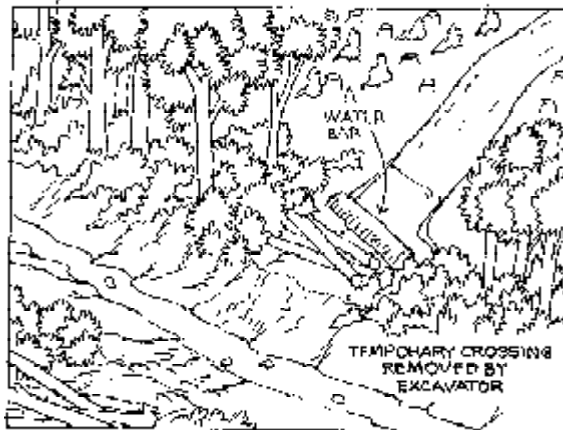
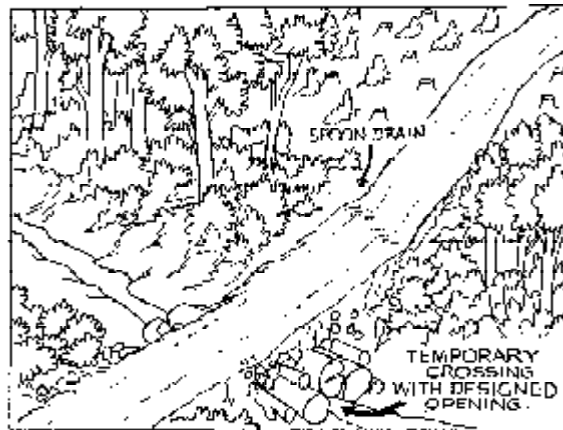

### B3.3 Road Surfacing

#### Basic Approach

- The road pavement for all weather permanent roads should be constructed with suitable material to produce a hard wearing and stable surface (preferably consisting of a mixture of evenly graded stone down to and including clay to bind it together).
- The thickness of the pavement required depends on the load bearing characteristics of the formation, the quality of the pavement material, the traffic load and density. As a guide, the following minimum thicknesses are suggested:
  - Class 1 and 2 roads – 300 mm consolidated;
  - Class 3 and 4 roads – 150 mm consolidated.

### B3.4 Steep Country (Slopes 20° and Above)

#### General Principle

- The following provisions in this section of the Code pertain particularly to steep country forest operations on slopes of 20° and above. Other relevant provisions of this Forest Practices Code apply independent of slope.

## Basic Approach

- A ridgetop roading approach should be used and midslope roads avoided as much as possible. However, plant communities with a priority for conservation, or visual skylines may require consideration (see Section D).

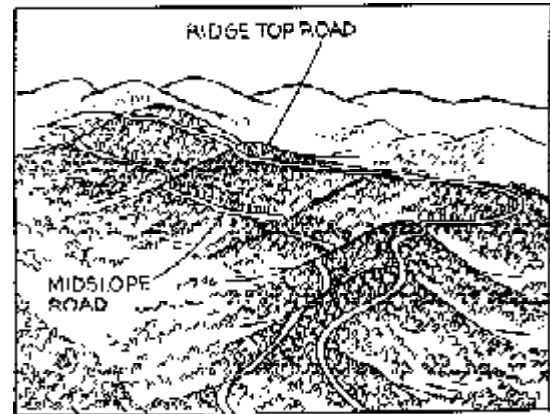

- Care will be taken to avoid potential slip zones. Field evidence of such zones includes landforms with hummocky or irregular shapes (often associated with basalt talus), mounds and hollows of older landslide scars, tree stem deformation, vegetation types, soaks or springs and recent ground movements. Soil/geological contexts also need to be considered, particularly the rock types given in Table 7, page 54. Consult with a soils or geotechnical specialist when in doubt.

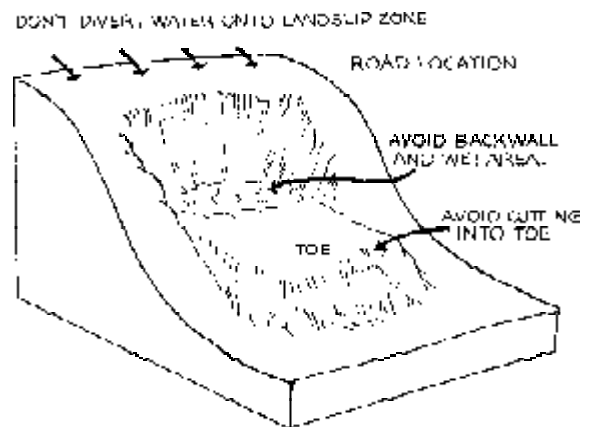

- To reduce the risk of culvert blockages on midslope roads:
  - the minimum culvert diameter will be 375 mm ;
  - the maximum spacing between table drain outlets and culverts should be reduced to 75% of those specified in Table 2, page 10.

- On slopes of 31° or above a form of construction will be adopted which ensures the stability of the road structure and continued trafficability of the road (e.g. full benches).

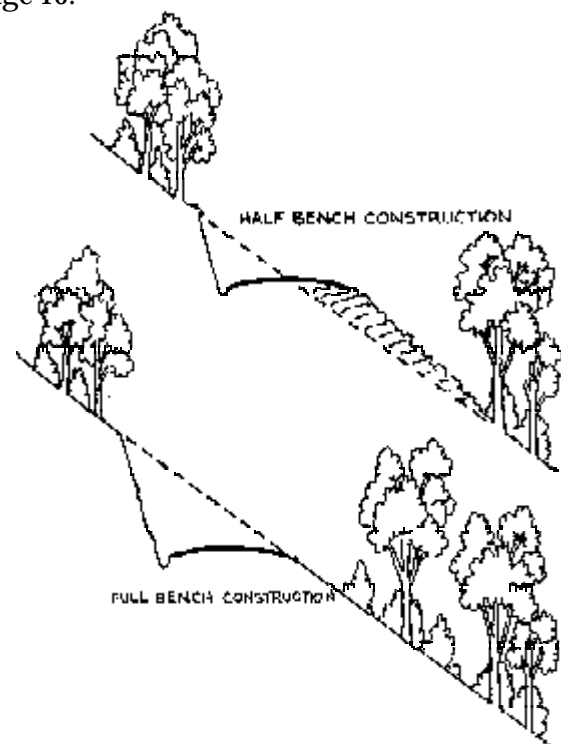



- Surplus fill which would otherwise have entered a streamside reserve or a Class 4 machinery exclusion zone, will be disposed of by end hauling or otherwise contained.
- Cut batters should be stood up as steep as possible without risking undue batter slumping to reduce the volume of material to be excavated and the visual impact. Soil and ground cover should be maintained on top of the cut batter.
- During the construction and commissioning phase, a windrow (or berm) of fill material should be retained on the outside fill shoulder sufficient to compensate for the settlement of material which has been side cast. Ensure adequate draining through the windrow.
- Tension cracks appearing in road shoulders should be sealed without delay with clay or unsorted fill to prevent slumping caused by the ingress of water into the fill. Geotechnical advice should be sought when large extension cracks occur, or when cracking occurs regularly.
- The fill slopes on the discharge end of culverts will be protected where excessive scour is likely to occur e.g. with armouring, rip rap, geotextile, steel or concrete drains. Refer to the diagrams on page 16.
- Spoon drains should be constructed across roads no longer used for regular access.
- If cable harvesting to the road, protect the road from excessive shoulder damage and keep table drains and culverts clear at all times so as not to concentrate water flows.
- Where culvert pipes are laid on fill special consideration will be given to accommodating the anticipated movement of the pipes e.g. rubber ring jointed pipes, external bands etc.

## **B4. Upgrading Existing Roads and Access Tracks**

### **Basic Approach**

- Substantial upgrading of roads is regarded as road construction for the purposes of this Code, and the approach detailed under Section B3 should be followed where practical.
- Existing roads and access tracks that do not meet current Code specifications, and that are causing or likely to cause significant environmental damage to soil or water values, will be upgraded within harvesting coupes, (and should be upgraded elsewhere) to rectify these problems, or be closed and the sites rehabilitated. Significant environmental damage includes one or all of the following:
  - a long term increase in watercourse turbidity, measurable as an increase in median turbidity by over 20 nephelometric turbidity units (NTUs) over a 2 week period, or associated death of aquatic fauna;
  - blockage of watercourse channels;
  - mass slumping or deposition of material into the watercourse;
  - significant active erosion of table drains and/or the road surface.
- Consideration will be given to replacing structures which impede the passage of aquatic fauna with more appropriately designed structures over time.

## B5. Quarries and Borrow Pits

### General Principles

- The number of quarries and pits opened should be kept to the minimum that can be justified for operational purposes.
- Quarries and borrow pits will be located and worked to minimise their impact on natural and cultural values.

### Basic Approach

- Quarries that are established on State forest or Private Timber Reserves and are used exclusively for the sourcing of materials used for the construction and maintenance of forest roads are administered by means of a Forest Practices Plan. These plans require further approval by DPIWE if they exceed the annual production limits of 5,000 m<sup>3</sup> quarried or 1,000 m<sup>3</sup> crushed per annum . Refer to the *Quarry Code of Practice* <sup>2</sup>.
- Quarries not conforming to the above conditions (i.e. commercially operated quarries) will require a permit issued by local government.
- New borrow pits will be operated and rehabilitated within one year of opening, and will be covered by a non-quarry Forest Practices Plan. Rock crushing will not take place and the amount of material removed will not exceed 5000 m<sup>3</sup>. If any of these conditions are to be exceeded, a quarry approval as per this section will be required.
- A mining lease is also required from Mineral Resources Tasmania when the material used is not contained on the landowner's property or material is sold to outside parties as a commercial venture.
- Quarries should be planned and operated to conform with the principal measures and acceptable standards specified in the *Quarry Code of Practice* <sup>2</sup>.
- The Chief Forest Practices Officer will be consulted before quarries are opened in karst areas or in the catchment of a Category A or B karst area (as indicated in *An Atlas of Tasmanian Karst* <sup>3</sup>).
- Quarries or borrow pits will not be established within 40 m of any watercourse unless specific approval is given by the appropriate authority. Approval to locate a quarry or borrow pit closer than 40 m to a watercourse will not be granted by the appropriate authority unless stormwater from the quarry can be adequately settled and filtered.

- When work on any quarry or borrow pit commences:
  - the area of disturbance and vegetation clearance should be kept to the minimum necessary (but trees adjoining the site may need to be removed for safety reasons);
  - surface material (top soil and organic debris) will be stockpiled, uncompacted, for use in the final rehabilitation of the site.

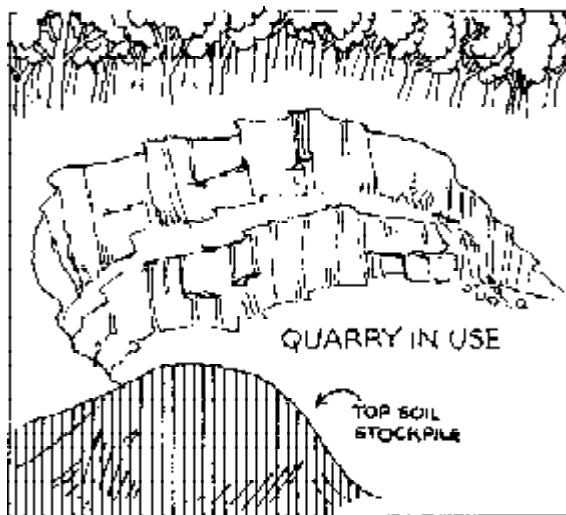

- To prevent spread of *Phytophthora* by mixing of top soil with quarry material, the surface material should be stockpiled on a dry elevated site so that the chances of mixing with quarry material is minimised. Runoff from this stockpile will be directed away from the quarry site. See also page 93.
- Quarries will be properly drained and well maintained, including provision of cut off drains to prevent drainage entering the quarry. Outlet drainage will be directed through a filter strip or silt traps and not directly into any watercourse.
- Silt traps and drains should be maintained to ensure continuing effectiveness.
- Quarries and borrow pits will be rehabilitated after use, or progressively as sections are no longer to be used. Techniques including grading slopes, ripping, resspreading stripped surface material and revegetating with suitable species so as to prevent invasion by other weed species, should be carried out as soon as possible (refer to the *Quarry Code of Practice*<sup>2</sup>).

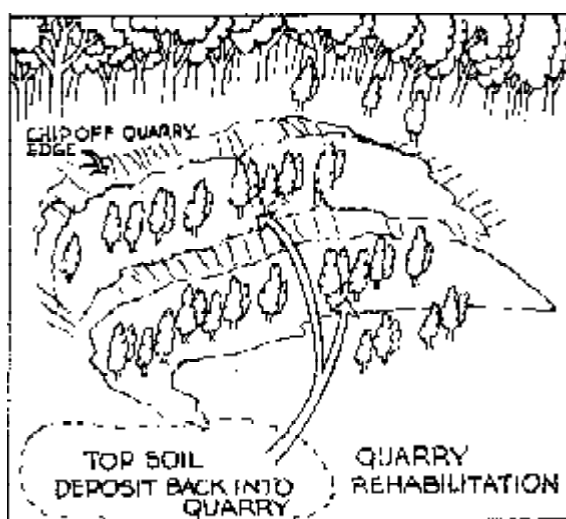

- Rehabilitation will take account of whether the quarry is suitable for or is used as an apiary site.

## B6. Bridge, Causeway and Ford Construction

### Basic Approach

- Permanent bridges on Class 1 and 2 watercourses should be designed to withstand the 1 in 50 year flood level.
- Earth covered bridges over any watercourse should be constructed so that the opening is not submerged by the 1 in 20 year flood level.

- Causeways and fords should be located and constructed so as to cause minimum disturbance to the streambanks, bed and natural flows. This can be done by avoiding deep box cuts on the approaches, protecting the road surface from scour (by using materials such as concrete or flexmat), and siting the crossing on a stable substrate with either sheet stone or a scour resistant material immediately downstream.

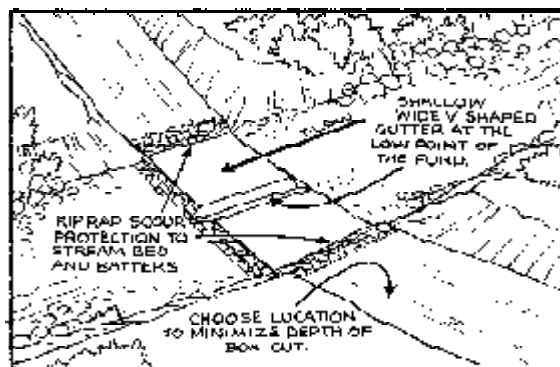

- Causeways and fords will be designed and maintained to minimise disturbance to the passage of fish and other aquatic fauna. Specialist advice should be sought.
- Plan activities in watercourses to coincide with low water flows, unless advice indicates this may have unacceptable adverse effects on fresh water flora and fauna, especially threatened aquatic species, in sensitive localities.

- Construction and other equipment will operate in a manner that will cause the least disturbance to the watercourse bed and banks:

- machinery will be kept out of the channel as much as possible, and points of entry should be located to minimise bank disturbance;
- fill will not be pushed into watercourses;
- surplus fill will be located at least 10 m from watercourse banks, separated by an effective filter strip (see also page 13);
- construction materials (e.g. concrete) will not be dumped into watercourses. Care will be taken to avoid spillages.

- Watercourse beds should be stabilised (e.g. by armouring the bed with large rocks). Streambanks and bridge embankments will be protected to minimise erosion. Suitable materials for use include concrete, timber, logs, vegetation or rip rap.

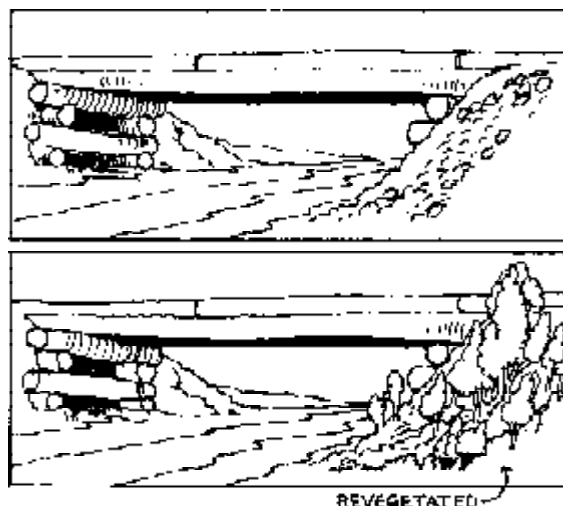

- Wooden bridges and components will be secured properly where they are likely to be subjected to high water flows. Bridge abutments should be placed above flood level, or where this is not feasible, placed so as not to significantly affect flow and channel characteristics.

## B7. Road Maintenance

### General Principle

- Regular maintenance of roads is essential to ensure that stable running surfaces and functional drainage systems are maintained. This is important to minimise sediment input to watercourses from roads.

### Basic Approach

- Road owners should have in place a system that ensures regular monitoring and maintenance of roads.
- Roads should be inspected regularly and action taken to prevent severe erosion or failure of roads, particularly in steep country. This includes:
  - restoration of the road formation or construction of water bars to prevent erosion;
  - clearance of table drains and culverts;
  - replacement of drainage structures before failure;
  - protection at culvert outlets to prevent scouring;
  - filling of settlement cracks.
- In steep country patrols should be carried out regularly and especially immediately after heavy rain. As a minimum patrols should be done at least twice a year in autumn and winter in areas:
  - of high and very high erodibility class soils;
  - prone to high intensity rainfall;
  - within 2 km upstream of town water supply intakes;
  - within susceptible domestic water supply catchments;
  - of high risk such as extended uniform grades on side slopes.
- All silt traps and sumps will be regularly inspected and maintained by clearing accumulated sediment.
- Control roadside vegetation only to the extent necessary to keep the road surface dry, to permit good visibility, and for weed and fire control purposes. Soil exposure on road verges should be kept to a minimum.

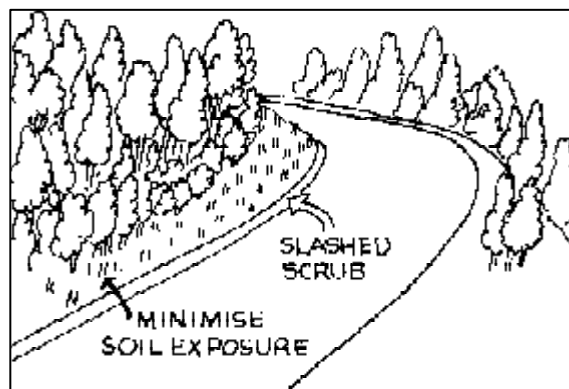

- On completion of harvesting operations, roads that are to be retained for fire control, forest management etc., will have drains and culverts cleared and road surfaces crowned. They will be left in a condition that minimises erosion and should be maintained in that condition.
- Roads of no further use will be outsloped, water barred, or otherwise left in a condition to minimise erosion, with clean drains and blocked to vehicular traffic. In some situations it may be desirable to recover existing gravel pavements and rehabilitate the road by ripping and sowing a suitable local native species seed mix.
- Drainage and crossing structures, in particular wooden structures, should be monitored and maintained on a regular and systematic basis. They should be replaced or removed prior to physical collapse so as not to impede water flows.

## **B8. Water Supply and Other Significant Catchments**

### **Basic Approach**

- Particular care should be taken and additional measures may be required in town or domestic water supply catchments, and in other catchments such as sensitive aquatic sites, including those important for threatened aquatic fauna or containing freshwater aquaculture facilities.
- Within 2 km upstream of town water supply and freshwater aquaculture facility intakes (see Appendix 2), specific conditions will be placed in Forest Practices Plans regarding:
  - timing of road construction;
  - methods of construction of watercourse crossings. e.g. ensure that earth is kept out of the watercourse, abutments are stable, earth on earth covered bridges is contained, and turbid runoff is minimised by using good quality hard wearing gravel without excess clay;
  - methods of road construction. e.g. use of silt traps, precast culvert heads, energy dissipaters at culvert outlets, revegetation of road batters, and lining of drains with riprap.

## C. HARVESTING OF TIMBER

### C1. Design, Planning and Equipment Considerations

#### General Principles

- Timber harvesting will be planned and carried out to minimise long term impact on the environment and to protect productivity of the site.
- Timber harvesting equipment should be selected to take account of the particular forest conditions at the time of harvesting.
- In most situations the number of snig tracks and landings used for timber extraction should be minimised, in order to limit the area of potential soil degradation.
- During the planning phase consider whether fire will be required to reforest the site, and how this will be managed.

#### C1.1 Dispersed Harvesting Design

##### General Principle

- By dispersing harvesting in space and time any localised impact on natural and cultural values will be reduced.

##### Basic Approach

- In native forest to be harvested by clearfelling and subsequently managed as native forest, planning should incorporate a dispersed coupe design. To achieve this:
  - a regeneration unit or cutting coupe should not exceed 100 ha but the requirement for safe burning boundaries may over-ride this limit;
  - the cutting sequence of regeneration units should where practicable be planned so that adjacent areas of native forest are not harvested until the dominant height of the regeneration of any adjoining coupe is at least 5 m and an acceptable stocking standard is achieved.

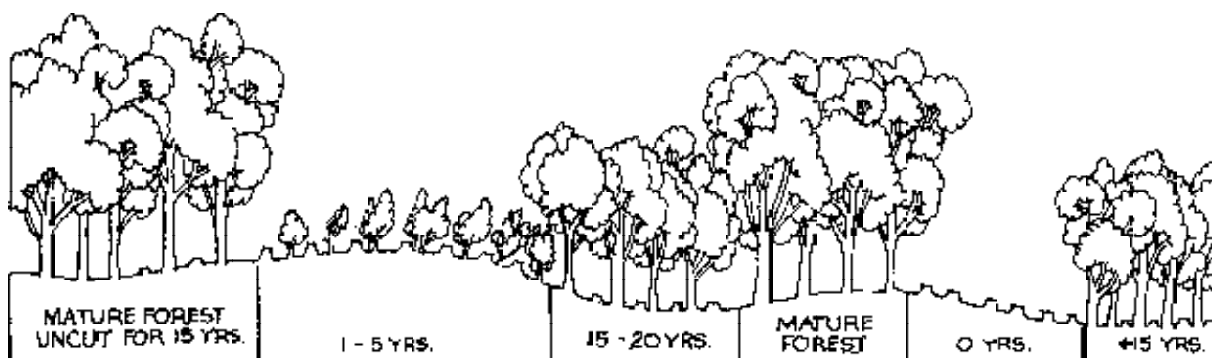

- Dispersed harvesting is desirable in non-clearfelling operations.
- Dispersed harvesting should be considered for plantations. Large blocks of plantation established at a similar time should be managed to improve dispersal over subsequent rotations.
- For steep country harvesting design see Section C6.
- Clearfelling will not be permitted on areas with vulnerable karst soils (see Glossary) unless authorised by the Chief Forest Practices Officer. Clearfelling should be avoided in other karst areas if high conservation or water supply values are present.

## **C1.2 Fire Planning**

### **General Principles**

- When designing a coupe that will require the use of fire for reforestation, consider how to prevent fire from damaging adjoining land, and how the coupe, once reforested, will be protected from invading fire.
- The risk of fire escape from harvesting operations needs to be minimised by ensuring that contractors are aware of fire prevention requirements, and are prepared in the eventuality of fire occurring.
- See Section E3.3 for burning in karst areas.

### **Basic Approach**

#### ***Coupe Design***

- Forest Practices Plans should include an evaluation of fire risk, and incorporate a design that is appropriate for fire management. Refer to the publications *Silvicultural Use and Effects of Fire*<sup>4</sup> and *High Intensity Burning*<sup>5</sup>.
- The fire risk associated with the surrounding land should be assessed on the basis of the type of fire hazard, the prevailing severe fire weather direction, and the proximity of the fire hazard.



- The topography, shape, size and boundaries of the coupe need consideration in the design phase. Where possible choose natural fire boundaries (e.g. ridgeline, moist gully). If constructed fire breaks are planned, avoid steep slopes into watercourses which may result in damage to retained vegetation, unnecessary earthworks, and inaccessibility for vehicles.

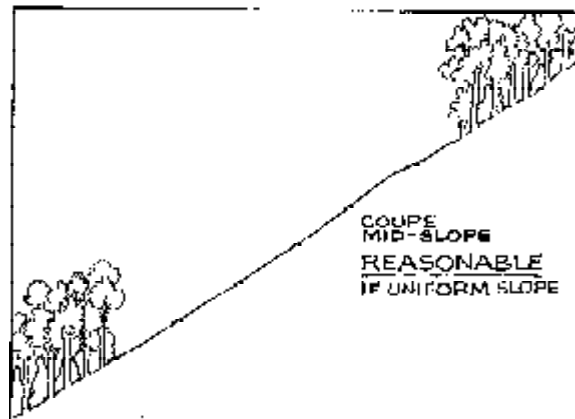
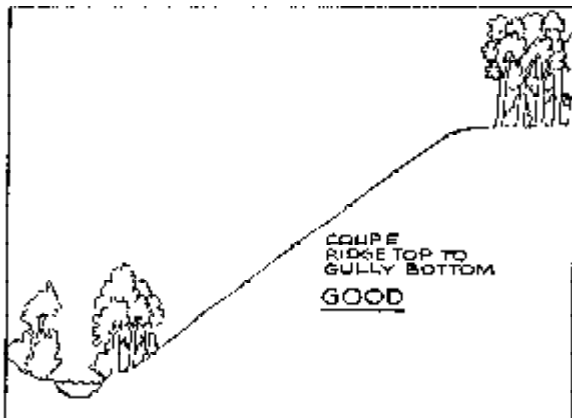
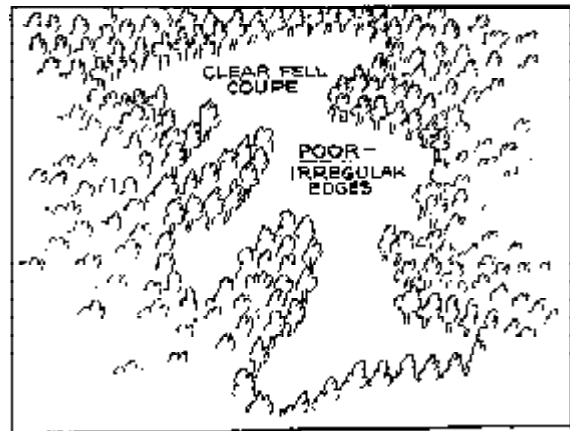
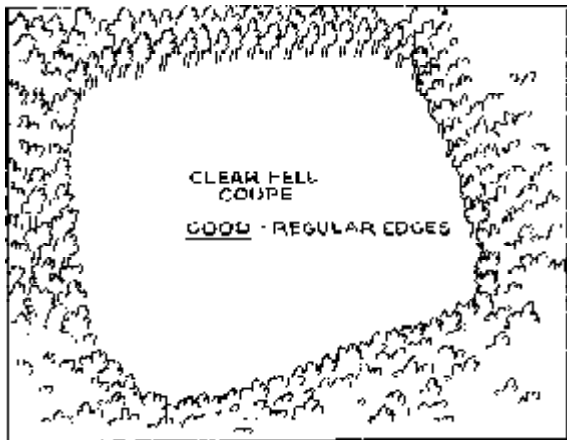

- In steep country (slopes 20° and above):
  - high intensity fires should be used only where essential for good regeneration (e.g. wet forest types and plantation establishment); however, the no burning option should only be used where it is possible to provide fire protection under a written fire management plan, and where identified in advance of harvesting;
  - low intensity fires should be the preferred options in dry forests;
  - harvesting should not proceed unless successful regeneration of eucalypts and other scrub or vegetative cover can reasonably be assured within three years of completion of harvesting or burning;
  - burning of streamside reserves and streamside vegetation adjoining Class 4 watercourses should be avoided wherever practicable.

**Fire Prevention**

- Timber harvesting operations should comply with the forest industry fire prevention protocol <sup>6</sup>, and the procedures for the suspension of hazardous activities for the duration of severe fire weather.
- Timber harvesting operations will comply with the equipment provisions contained in the Fire Service (Miscellaneous) Regulations 1996. Additional fire fighting equipment, as specified in the forest industry fire prevention protocol <sup>6</sup>, should be provided for cable harvesting operations.
- Timber harvesting contractors will comply with the stand-down provisions of the forest industry fire prevention protocol <sup>6</sup>.

**C1.3 Wet and Dry Season Site Selection**

- The following criteria should be considered when selecting areas for wet or dry season harvesting.

**Table 3. Wet or Dry Season Harvesting Criteria**

Aspects To Be Considered	Conditions Least Suitable For Wet Season Harvesting	Conditions More Suitable For Wet Season Harvesting
Soils	low load bearing capacity when wet (high clay, low rock content), poor drainage, high erodibility	high load bearing capacity (low clay, high rock content), good drainage, low erodibility
Slopes	steep grades or flat poorly drained land	gentle to moderate slopes
Roads	summer roads	all weather roads
Equipment Availability	high ground pressure	low ground pressure or cable
Sensitivity of Site	e.g. town water supply catchments, karst areas, threatened species habitat	

## C 1.4 Extraction Equipment and Soil Protection

### General Principles

- Harvesting machinery and techniques should be matched to forest conditions to limit the impact of harvesting on soils.
- The general level of training and skill of harvesting machinery operators should be progressively improved to assist in achieving environmental objectives.

### Basic Approach

**Table 4. Approximate Static Ground Pressures for Harvesting Machinery Classes**

Class		C1	C2	C3	C4 – C6
Ground Pressure	p.s.i.	Over 6	3 - 6	Less than 3	NA
	kPa	Over 40	20 - 40	Less than 20	NA

### Harvesting Machine Type Description

#### **C1 Conventional ground based snigging equipment including forwarders with standard tyres**

60-140 kPa – e.g. forwarders, harvesters

50-80 kPa – e.g. skidders, rubber tyred tractors, wheeled loaders, conventional ground based tracked tractors and loaders with standard grouser plates up to 60 cm wide on rigid track frame rollers

40-70 kPa – e.g. tracked tractors, tracked loaders

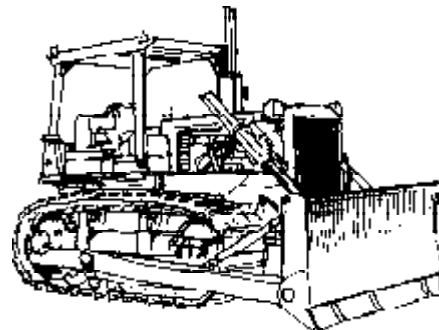
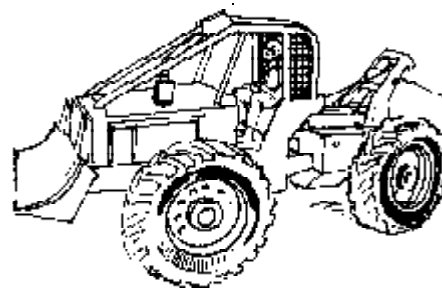

#### **C2 High flotation and low ground pressure equipment, as well as systems using slash, matting or cording which spread and reduce ground pressures effectively**

Up to 30 kPa – e.g. wide tyred skidders (tyre width averaging 100 cm)

30-40 kPa – e.g. wide tracked crawler tractors, some tracked harvesters. [High drive wide track machines (e.g. D5H Custom Skidder) fit approximately between classes C2 and C3]

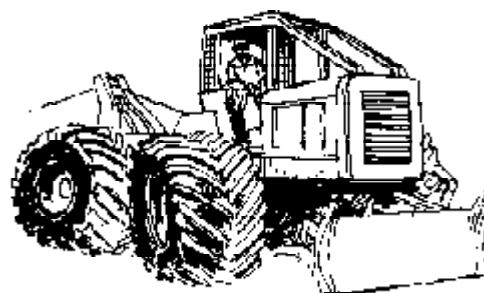

**C3 Machines featuring flexible wide tracks with rollers mounted on individual torsion bars that act to spread load evenly and shovel harvesting systems using excavators which lift and move logs from static positions**

15-45 kPa - e.g. FMCs and KMCs

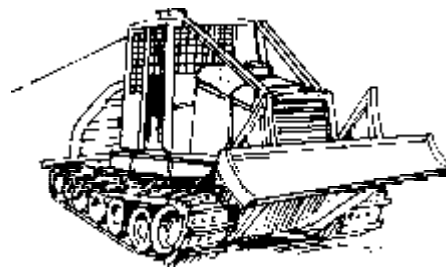

**C4 High Lead Cable Systems**

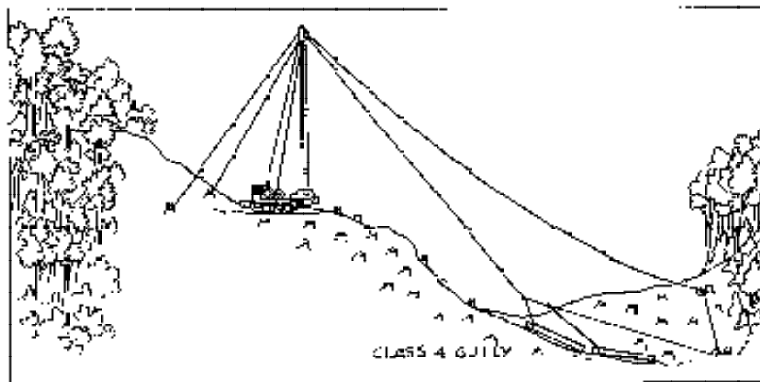

**C5 Skyline Cable Systems**

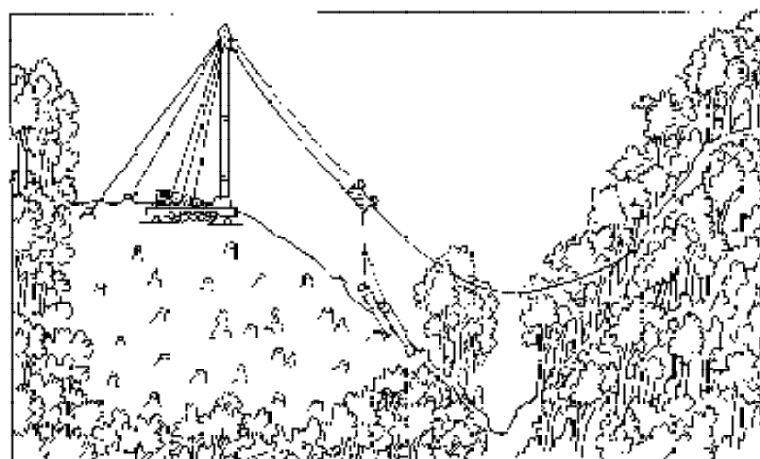

**C6 Non-mechanical Extraction (e.g. using bullock teams)**

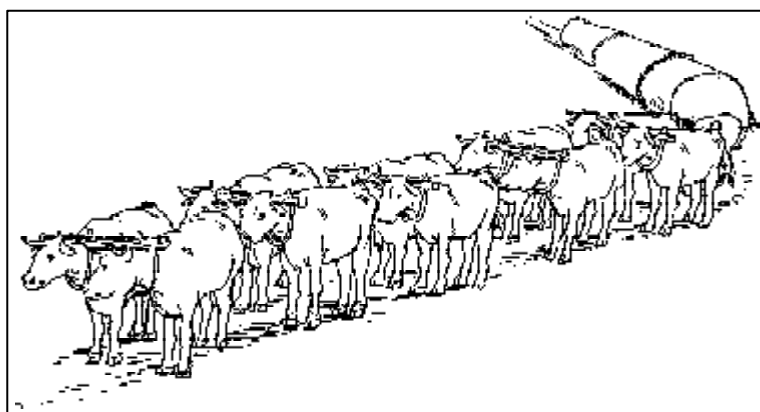

- The following table is a guide to harvesting machinery to be used under the forest conditions shown. This guide will continue to be progressively evaluated and reviewed. Operation outside this guideline will only be undertaken in consultation with the Chief Forest Practices Officer, who will consider soils or geotechnical advice. A Forest Practices Officer will decide which category applies in marginal cases, and for all C6 extraction methods.

**Table 5. Harvesting Machinery Guide**

Soil Erodibility Class <sup>(1)</sup>	Majority Slope							
	Flat - Rolling 0-11°		Hilly 12°-19°		Steep 20°-26°		Very Steep 27° - 35°	
	Dry <sup>(4)</sup>	Wet <sup>(4)</sup>	Dry	Wet	Dry	Wet	Dry	Wet
Low	C1-5	C1-5	C1-5	C1-5	C1-5	C3-5	C4-5	C4-5
Moderate	C1-5	C1-5	C1-5	C1-5	C1-5	C4-5	C5	C5
Mod-High	C1-5	C1-5	C1-5	C2-5	C5	C5	NH <sup>(3)</sup>	NH <sup>(3)</sup>
High	C1-5	C2-5	C1-5	C3-5 <sup>(2)</sup>	C5 <sup>(6)</sup>	C5 <sup>(6)</sup>	NH <sup>(3)</sup>	NH <sup>(3)</sup>
Very High	C1-5	C4-5	C5	C5 <sup>(2)</sup>	NH <sup>(3)</sup>	NH <sup>(3)</sup>	NH <sup>(3)</sup>	NH <sup>(3)</sup>
Low Load Bearing Strength Soils	C1-5	C2-5	C1-5	C3-5	C1-5	C3-5	C4-5	C4-5

**Note:**

- 1 See Appendices 3 and 4 for High and Very High Erodibility Class Soils
- 2 Slope limits should be 14° for ground based harvesting on sandy granite derived soils under dry forest.
- 3 NH – generally no harvesting.
- 4 Wet and Dry refer to Wet and Dry Season Conditions (see also Table 3, page 29).
- 5 In karst areas ground based systems will be limited to slopes below 20°. On vulnerable karst soils (see Glossary) harvesting on slopes above 9° will be restricted to uphill cable harvesting. No harvesting will be permitted on slopes above 20°.
- 6 A slope limit of 22° should be applied.

## C1.5 Felling

### Basic Approach

- Harvesting boundaries will be marked before falling commences unless they are clearly delineated by a change in vegetation, such as a forest/pasture boundary. The responsibility for boundary marking will be stated in the Forest Practices Plan.
- Control the manner in which trees are felled to facilitate extraction, remain clear of watercourses and streamside reserves, reduce damage to retained trees and improve recovery of useful products. See also Section C4, page 45.

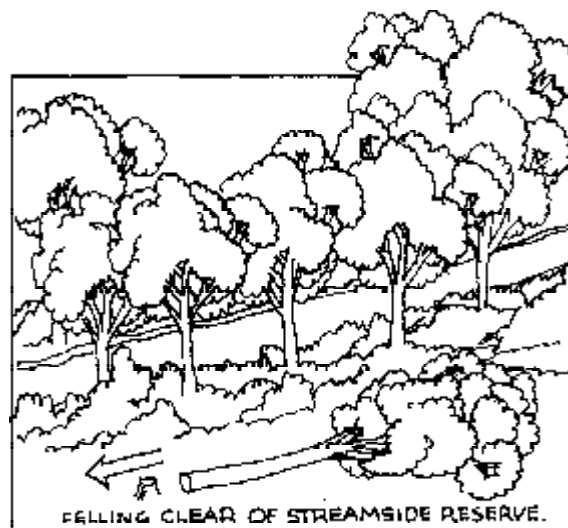

- Trees will not be felled outside boundaries designated for harvesting in a Forest Practices Plan. Felling of trees across boundaries into areas reserved from harvesting will be avoided where possible.

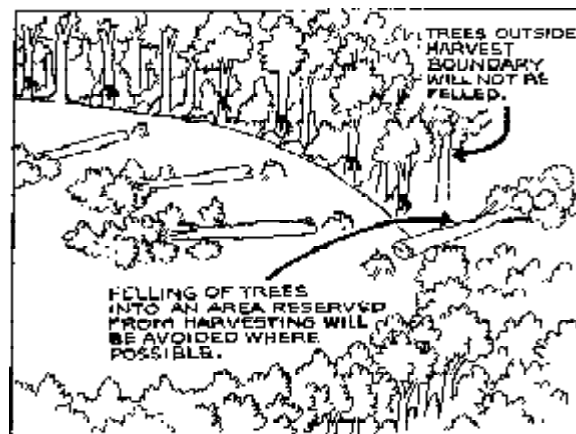

- In particular, damage to retained vegetation around the perimeter of the coupe should be avoided. Any debris which falls outside the marked boundary should be carefully pulled back inside the harvesting boundary if it constitutes a fire hazard.

## C2. Wet Weather Limitations

### General Principles

- Avoid the use of ground based harvesting equipment on saturated soils (see Appendix 5) to minimise soil erosion, puddling, mixing and compaction and adverse effects on water quality.
- Soils need to be allowed to drain after heavy rainfall events before forest operations recommence.
- Avoid carting on wet, rutted roads to reduce excessive turbid runoff which may adversely affect water quality, and may increase the need for road maintenance.
- A complete closure of forest operations including carting may be required in extreme conditions such as prolonged heavy rainfall events.
- Equipment selection should comply with Table 5, page 32.
- The establishment of landings and major snig tracks during dry conditions with cording and matting, where practicable, will reduce the potential for soil damage.

### Basic Approach

- Harvesting on vulnerable karst soils (see Glossary) will only be permitted in dry season conditions.
- The number of snig tracks will be minimised. Major snig tracks should not total more than 10% of the harvested area of the coupe, except where outrow or similar thinning techniques are used.
- The depth of rutting on snig tracks will be minimised.
- Major snig tracks to be used for harvesting during wet periods should be planned before operations start. These snig tracks should be corded or matted where appropriate and feasible. Snig track direction will be indicated on the Forest Practices Plan map.

- Cording or matting of all wet weather snig tracks prior to use is recommended according to the availability of materials. Where bark is used for cording it should preferably be placed on top of other cording materials because of the adverse effects of bark mixing with soil.

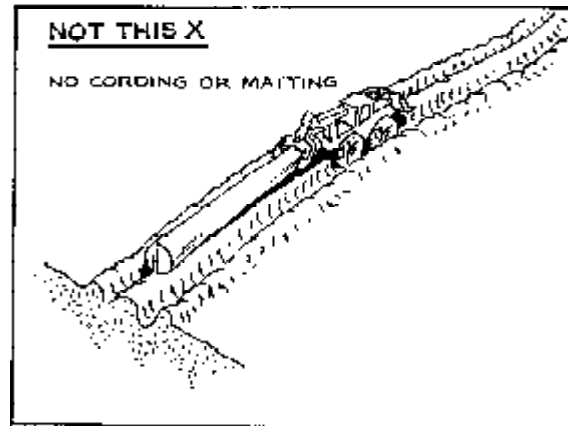
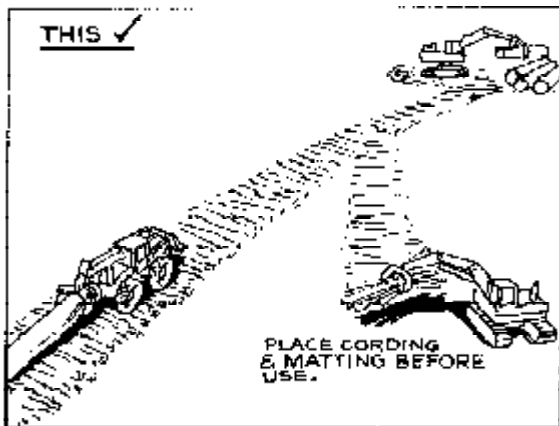

- High intensity snigging traffic will be confined to planned tracks which should be located on high ground so they drain naturally.
- The harvesting contractor or their nominated person in charge of a harvesting operation will ensure that ground based snigging will cease on that section of a coupe where:
  - soils are saturated (see Appendix 5) and turbid water is flowing down a snig track for more than 10 m; or,
  - soils are puddled forming mud or slurry along a snig track to a depth of more than 200 mm over a 20 m section or longer; or,
  - blading of mud or soil is required to maintain the trafficability of a snig track; or,
  - turbid water or mud is flowing from a snig track into a watercourse or lake and immediate action will be taken to divert the flow away from the water body; or,
  - on that part of feeder snig tracks where soils are rutted to a depth of more than 300 mm below the original ground level over a 20 m section or longer.

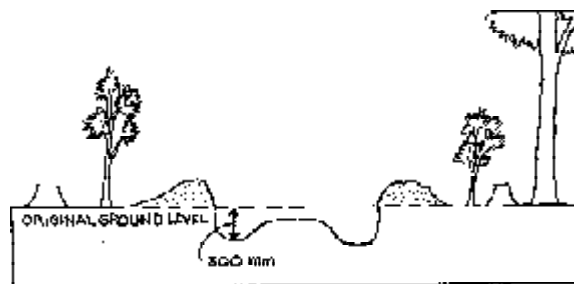

- The affected section of the snig track will not be by-passed by opening up a new snig track alongside or close by if on similar saturated ground conditions. Operations may be shifted to another section of the coupe or another coupe with better ground conditions or the tracks may be corded.

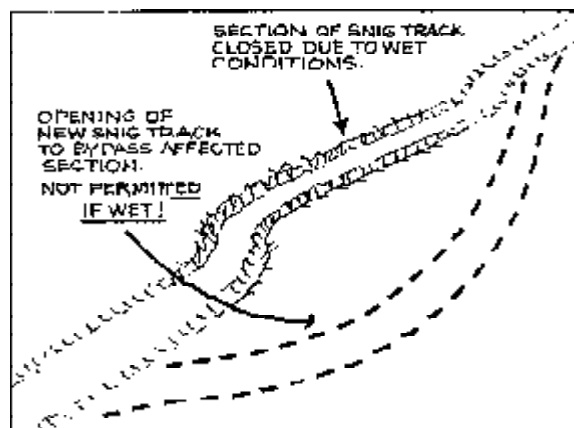

- Ground based snigging in a section of a coupe may recommence only after water or mud ceases to flow on snig tracks in that section of the coupe. A Forest Practices Officer may extend this partial closure where it is necessary to allow further time for draining and drying. The extension will depend on the harvesting equipment in use, soil type and conditions.
- The area of damaged soil (see Glossary) due to landings and snig tracks will be minimised, and should not exceed 10% of the coupe area.
- The contractor or their nominated person in charge of carting will ensure that carting will cease on wet roads when:
  - trucks are unable to travel under their own motive power;
  - turbid water or mud runs in wheel ruts that are deeper than 100 mm in the running surface of the road for a distance greater than the required culvert distance for that section of the road.
- A Forest Practices Officer may close cartage operations on new roads or other roads with poorly bound surfaces if damage including significant sediment runoff into watercourses is being caused or is likely to be caused by wet weather carting.

### **C3. Snig Tracks and Landings**

#### **General Principles**

- The area covered by snig tracks and landings should be minimised.
- Planned snig track and landing locations will result in less of the coupe being heavily disturbed, reduced snig track grade and shorter average snig distances.
- Careful attention will be paid to the location, construction and post harvesting treatment of snig tracks and landings to minimise erosion, compaction, soil puddling and mixing and excessive runoff.
- The amount of soil movement will be minimised. This can be facilitated by cording of snig tracks and landings prior to use where materials are available.
- Bark mixing with soil should be minimised as severe nutritional deficiency can result.

#### **C3.1 Snig Tracks**

##### **Basic Approach**

- The design of the snig track system should be discussed with the harvesting contractor. This should improve the efficiency of extraction and reduce the subsequent cost of restoration works.
- Snig tracks will not cross a Class 1 or 2 watercourse except that the Chief Forest Practices Officer may authorise forwarders to use a culverted or bridge crossing provided measures to avoid sediment entering the watercourse are implemented.



- The number of crossings of Class 3 and 4 watercourses will be minimised and restricted to clearly marked crossing points (but see Thinning Operations, page 38). Crossing points on any watercourse should be at least 100 m apart. Crossings will not be used while water is flowing over them.

- Dry Class 4 watercourses may be crossed without log crossings or culverts provided:

- soils are dry and in low to moderate soil erodibility classes;
- banks into the watercourse are gently sloping (0-11°);
- the number of crossings are minimised (but see Thinning Operations, page 38).

CROSSING A DRY CLASS 4 WATERCOURSE WITHOUT USING LOGS OR A CULVERT

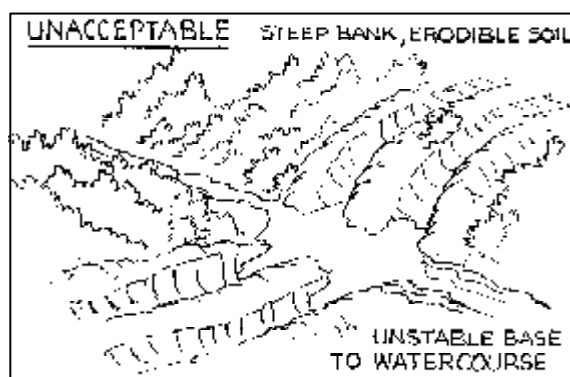
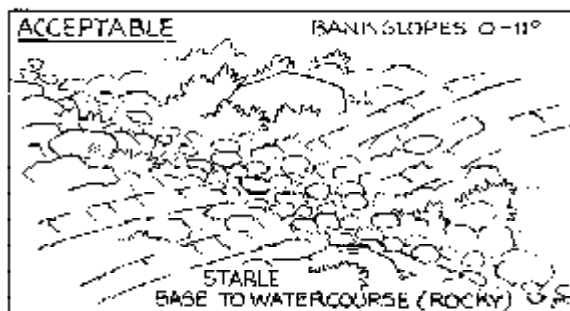

- Temporary culverts or log crossings will be provided in all other crossings.
- Crossings to be used for more than 12 months will be constructed with an opening (e.g. log culvert, see diagram page 41) designed to cope with the typical winter peak flows.
- Machine damage to streambanks should be avoided.
- Snigging will not be conducted along watercourses.
- Snigging will not be conducted along drainage depressions in native forests. However, snigging along drainage depressions in plantations may be authorised by a Forest Practices Officer provided:
  - soils are dry, and less soil disturbance will result than if an alternative route were used;
  - soils are in the low to moderate-high erodibility classes;
  - slopes along the drainage depression are no greater than 6°;
  - the snig track is matted prior to snigging.

- Snig tracks will not cross mapped caves that are near the surface, enter any karst depression (see Glossary), or divert or enter any watercourse in a karst area. Concentration of drainage will be avoided.
- New caves or streamsinks found during harvesting will be avoided and the Chief Forest Practices Officer advised as soon as possible.
- Snig tracks should be located and constructed so they can be effectively drained.
- Major snig tracks should be located on high ground so that they can drain naturally.

- Uphill snigging will be maximised on very high erodibility class soils (see Appendix 3). In other areas:

- an uphill or contour snigging pattern is recommended generally;
- where uphill snigging is not feasible or would cause excessive wheel spinning and rutting, pulling may be downhill but major snig tracks should be on spurs and ridges.

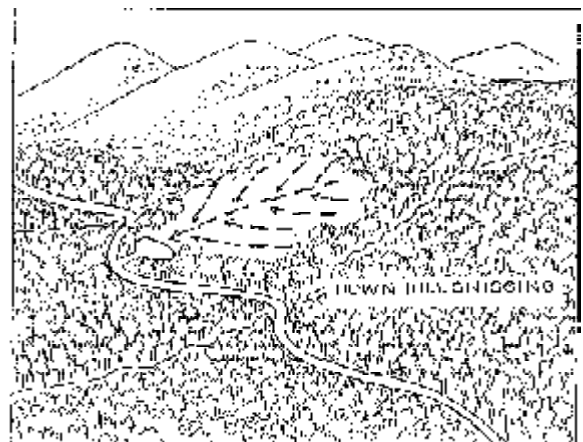
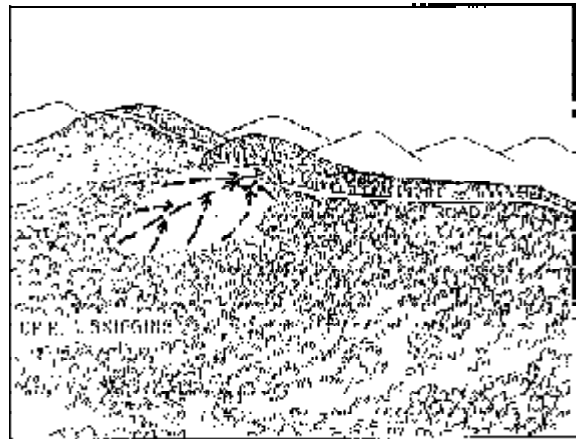

- Snig tracks should be corded or matted during construction in wet areas and temporary culverts used to reduce soil degradation and maintain trafficability and water quality.

- Outsloping of snig tracks should be considered to reduce scouring. The outslope should be about 1° but not more than 4° as logs slide off slopes greater than 4°.



- Machines should only cross table drains and road batters when absolutely necessary. Stable crossing points should be used, avoiding culvert inlets and outlets. A Forest Practices Officer may specify permissible machinery use of a road in a Forest Practices Plan.

### ***Thinning Operations***

- Harvesting machinery and thinning regimes should be selected that minimise soil compaction and damage to retained trees.
- Existing stabilised tracks within 10 m of a Class 4 watercourse may be used for snigging along, provided:
  - snigging is undertaken in dry conditions and streambanks are not damaged;
  - no reasonable alternative exists;
  - use is specified in the Forest Practices Plan.
- The wet weather limitations for major snig tracks should be applied to outrow thinning tracks.
- In wet conditions where outrow or similar thinning techniques are being used, slash and branches will be placed on outrow extraction tracks to minimise soil and root damage.

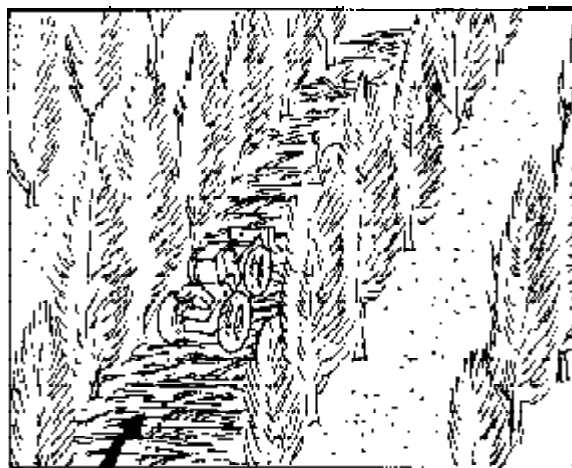

- In outrow or similar thinning of plantations, non-ground skidding equipment (e.g. forwarders, feller bunchers, processors) can cross Class 4 watercourses where the outrow intersects the watercourse provided:
  - the watercourse is dry;
  - harvesting conditions are dry;
  - damage to banks is avoided;
  - no or minimal earthworks are required;
  - slash is placed on the outrow crossing during harvesting, and removed after harvesting.
- For operations using exclusively non-mechanical (C6) extraction equipment, the Forest Practices Officer may specify alternative provisions in the Forest Practices Plan to those under Section C3.

### **C3.2 Snig Track Restoration and Control**

#### **General Principles**

- Basic snig track drainage to prevent a build up of running water should be undertaken progressively.
- Complete restoration should be undertaken on completion of a section of a coupe provided conditions are dry enough to allow restoration works to be effective. If not dry enough, restoration should be done within a specified time.

#### **Basic Approach**

- On soils in the low to high erodibility classes, snig tracks should be drained as soon as they are no longer needed for harvesting or if harvesting is to be closed down for one week or more and it is practicable to do so.
- On soils in the very high erodibility class, snig tracks will be drained and restored as per Appendix 3.
- Where machine clearing for plantations or agriculture is specified in the Forest Practices Plan, or complete restoration prior to coupe clearance would not be effective due to unforeseen circumstances (e.g. sudden onset of a wet spell), then:
  - partial restoration, to minimise erosion and ensure turbid water does not enter watercourses, will be undertaken;
  - complete restoration will be undertaken at time of machine clearing or when conditions are dry enough to effectively restore the tracks, but in any case before the next burning season.
- Where machine clearing after harvesting is not specified in a Forest Practices Plan and when ground conditions are suitable for effective restoration, snig tracks and access tracks will be drained to minimise erosion, siltation and excessive runoff of water prior to clearance from a coupe or harvesting section as follows:
  - cross drains will be constructed approximately at a right angle to the water flow and have an outlet so that water discharges into the surrounding vegetation or harvesting slash;

- natural drainage points should be used;
- the maximum spacing between cross drains on the basis of soil erodibility class and average track gradient is given in Table 6 below.
- drainage will be by cross drains (grips) as specified in Table 6 below, (unless otherwise specified by a Forest Practices Officer), to minimise the concentration of water and to reduce its velocity and hence reduce erosion and adverse effects on water quality;
- cross drains will be constructed approximately at a right angle to the water flow and have an outlet so that water discharges into the surrounding vegetation or harvesting slash;
- natural drainage points should be used;
- the maximum spacing between cross drains on the basis of soil erodibility class and average track gradient is given in Table 6 below.

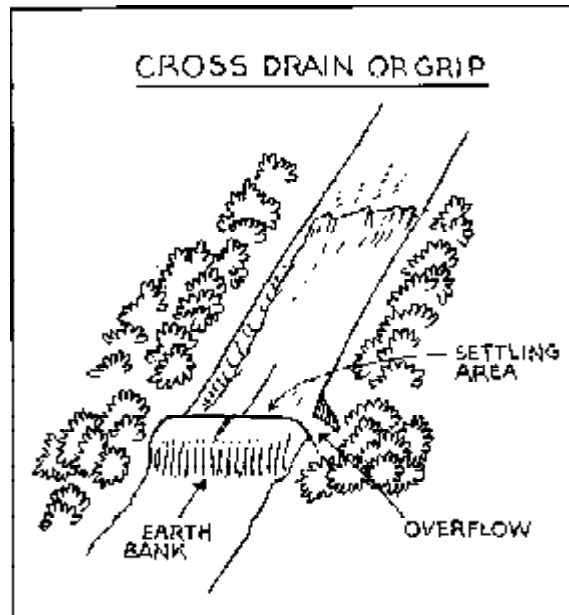

**Table 6. Maximum Spacing between Cross Drains on Snig Tracks**

Gradient of Snig Tracks	Soil Erodibility Class				
	Low	Moderate	Moderate-High	High	Very High
0-3°	Nil	Nil	Nil	100 m	40 m
4-14°	120 m	100 m	80 m	60 m	30 m
15-19°	80 m	70 m	60 m	40 m	20 m
20-26°	40 m	35 m	30 m	20 m	NH
over 26°	20 m	20 m	NH	NH	NH

**Note:**

NH = generally no harvesting

Apply cross drain standards for high erodibility class on all karst soils. Sediment traps may be required.

Use drain spacings corresponding to the next highest soil erodibility class for the following situations:

- tracks diagonally across contours;
- areas subject to periods of high rainfall intensities, e.g. eastern parts of Tasmania;
- karst catchments.

- Where snig tracks are rutted to a depth of more than 300 mm below the original ground level, over a 20 m section or longer, the snig track will be restored by filling in and draining.
- Other rutted snig tracks may be restored by backfilling provided such tracks are drained or gripped to prevent channelling of surface flows.
- Cording and matting should be loosened to facilitate burning or heaped to expose seedbed where necessary.
- On completion of harvesting or site preparation, temporary log crossings will be removed from watercourses to allow the watercourse to flow unrestricted along its original course. The streambanks at temporary crossing points will be left in a stable condition.

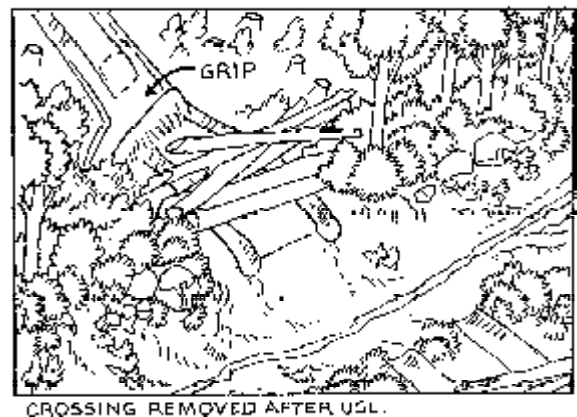
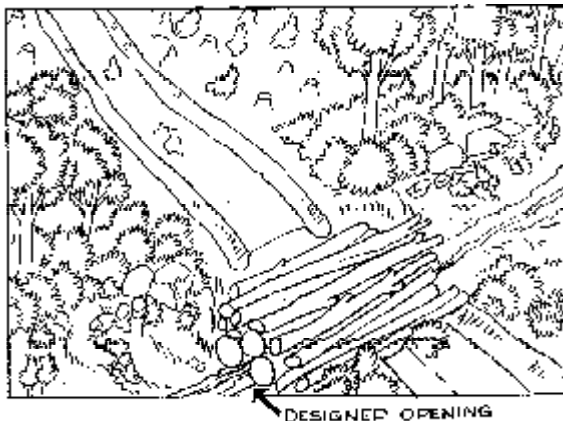

- If a watercourse is diverted onto a snig track at a crossing point, action will be taken to restore the water flow to its original watercourse. This action will be immediate unless a Forest Practices Officer specifies a delay until drier conditions prevail.

### C3.3 Landings

#### Basic Approach

- Landings will be located so that mud and slush from them does not enter watercourses.
- To reduce fire risk and visual impact, landings and log dumps should not be located in uncut forested areas outside the coupe to be harvested.
- Where safety concerns are present, the contractor can move a landing up to 50 m from the position indicated on the Forest Practices Plan map provided other provisions in this Code and within the Plan are complied with, and a Forest Practices Officer is notified of the intention to move the landing.
- Landings should be kept as small as practicable and will not exceed 0.2 ha (equivalent to 40 x 50 m) excluding stockpile areas except as below. Landings of up to 0.3 ha are permitted if authorised in a Forest Practices Plan e.g. for safety reasons, or where there is a large number of log sorts.
- Landing size will be minimised in karst areas and landings will not be located near karst depressions or sinkholes.
- Landings in areas with vulnerable karst soils (see Glossary) will be drained into effective sediment traps which are properly maintained.

- Continuous roadside landings can be used if approved by a Forest Practices Officer in existing plantations or in areas to be converted to plantation or agriculture, or where special equipment is used (e.g. cable swing yarder or cable thinning machine), provided:
  - drainage depressions are avoided;
  - the allowed limits of landings are marked on the road edge where near drainage depressions or streamside reserves;
  - stockpiling by machines not standing on roads is in dry conditions, or if not in dry conditions then provided slash or cording is placed on high use areas.
- Landings (including harvesting debris) should be kept as far as practicable from watercourses. Landings will not be permitted within 40 m of a streamside reserve or a Class 4 machinery exclusion zone (see page 56) unless designated in a Forest Practices Plan and provided specific measures, (e.g. marking the landing boundary, drainage controls), are placed in the Plan to protect water quality.

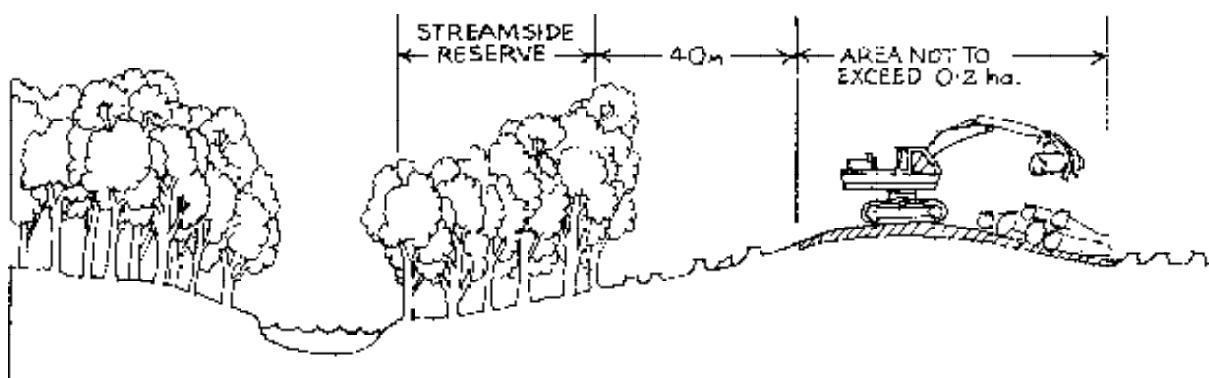

- Landings will be well drained at all times and should be located on gently sloping elevated areas.
- Mud and water should be prevented from entering landings from snig tracks, and logs prevented from sliding uncontrolled into landing work areas. This is best achieved where snig tracks approach landings from below.

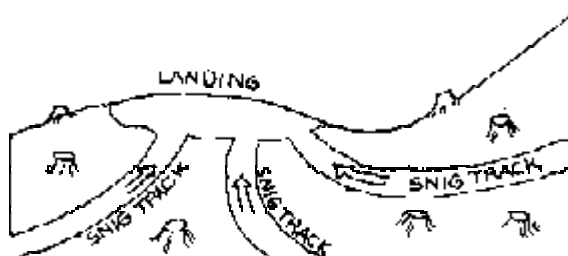

- Wet season landings to be used by wheeled or crawler non-swivel type loaders will be corded or gravelled if a rocky or suitably solid base is not available.

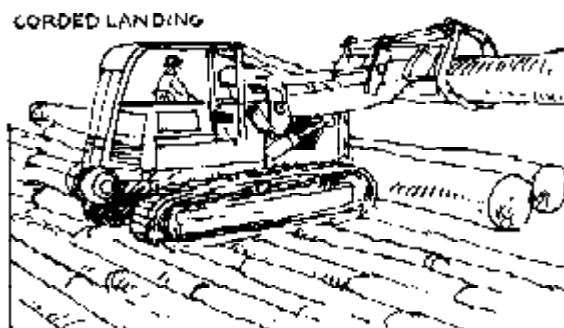

- Permanent landings (e.g. gravelled cable landings, landings to be used frequently for thinning or selective harvesting operations) should be considered part of the long term extraction network and constructed along with the roads.

- If conditions are dry temporary landings should be established by placing cording or matting over the landing at the commencement of use, while ensuring bark mixing with the topsoil is minimised.
- For temporary landings not established in dry conditions, where topsoil is suitable for stockpiling (non-rocky organic A horizon soil to a depth of 150 mm depth), soil stockpiling should be carried out as follows:
  - strip topsoil uphill and stockpile so that it does not become waterlogged;
  - locate stockpile in an easily accessible position for respreading;
  - keep stockpile separate from vegetation, bark, mud and butts.

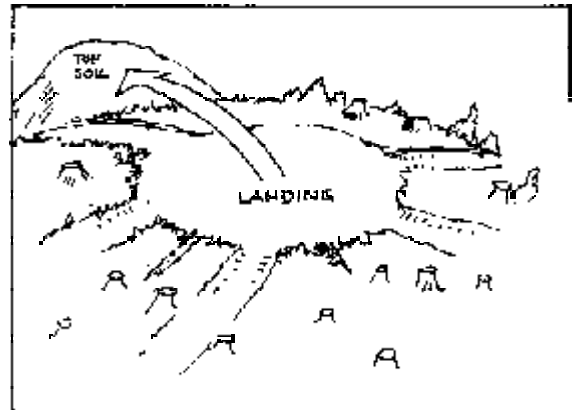

### C3.4 Landing Restoration

#### General Principles

- Proper drainage of landings reduces soil erosion and turbid runoff.
- Proper bark management is essential to reduce fire risk.
- Adverse visual impact can be reduced by keeping landings tidy.

#### Basic Approach

- On completion of each harvesting section landings will be drained, and water flowing towards landings will be diverted into the surrounding vegetation or silt traps.

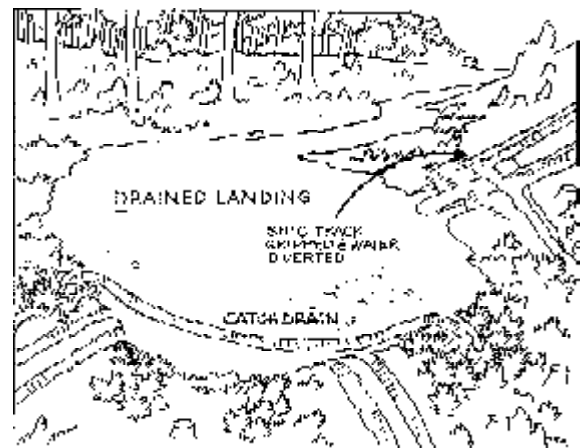

- Where complete restoration of a landing is not advisable due to wet conditions or other factors, temporary drainage will be undertaken before leaving the area. Complete restoration will be undertaken when conditions are dry enough to effectively do the work required but in any case before the next burning season.
- Rubbish, waste oil, etc. will be removed as per Section F.



- Where harvesting slash in a coupe is to be left unburnt or reduced by low intensity burning, bark and wood debris heaps will not be left on a landing, or burnt, unless authorised by a Forest Practices Officer who has taken into consideration the broader fire management implications.

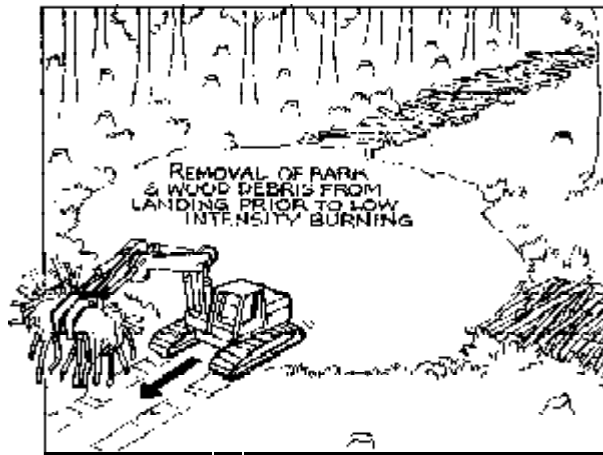

- Where harvesting slash in a coupe is to be burnt by high intensity fire, the following procedures will apply:

- large waste wood pieces (>25 cm diameter) will be heaped separately from bark;
- bark heaps will be piled onto a raft of light (<20 cm diameter) limbwood placed on a well drained site previously cleared to mineral earth. If not part of a landing, the bark heaps will be isolated from adjacent flammable material by a 3 m firebreak cleared to mineral earth;
- bark heaps should not be compacted, and should be no greater than 4 m in height where landing space permits;
- all heaps will be at least 40 m from a flammable coupe or reserve boundary;
- rubbish, metal, oil and other foreign matter will not be included in either bark or waste wood heaps;
- compacted bark will be aerated before being added to bark heaps;
- bark and waste wood heaps should not be ignited until the summer fire danger period has passed. Bark heaps which are still burning when the local soil dryness index exceeds 50 mm in spring will be extinguished.

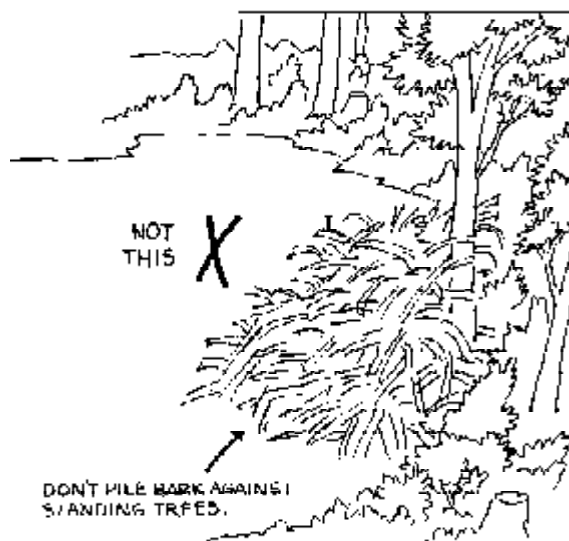
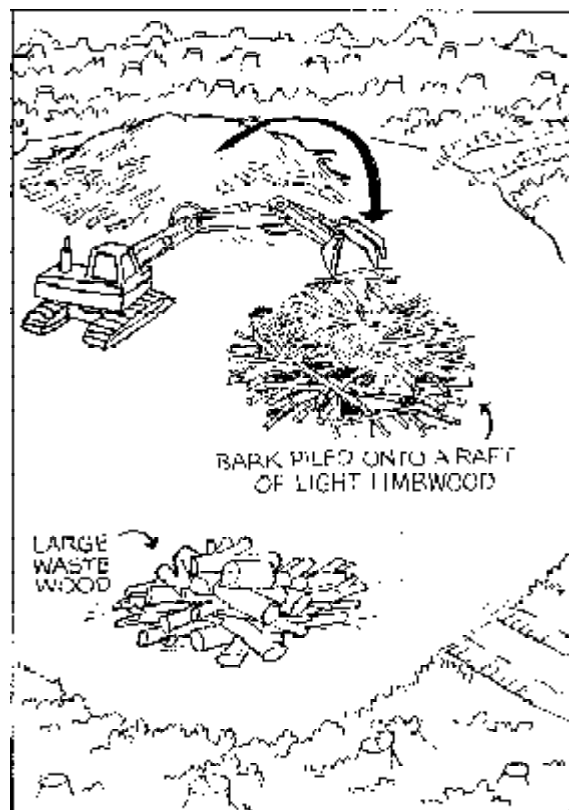

- For temporary landings after completion of harvesting and bark treatment:
  - the general original ground contour of the landing should be re-established;
  - ripping may be necessary on some sites to improve soil structure;
  - stockpiled top soil will be spread over the landing;
  - landings will at least receive the same reforestation treatment as the surrounding logged over forest.

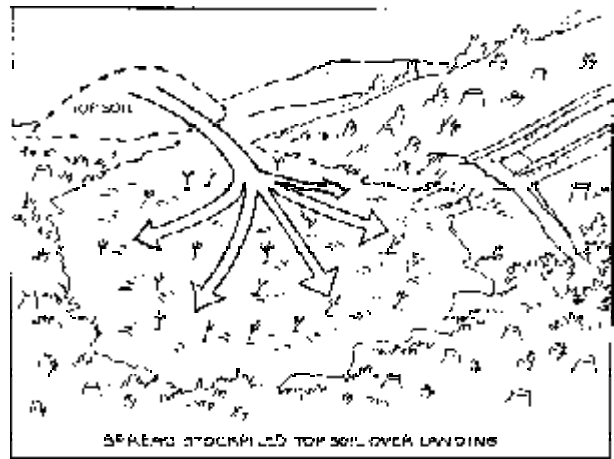

## C4. Water Quality and Watercourse Protection

- See also Section D2.

### C4.1 Native Forest Streamside Reserves

#### Basic Approach

- Native vegetation will be retained intact in Class 1, 2 and 3 streamside reserves as defined in Table 8, page 56, subject to other provisions in this Code permitting watercourse crossings and selective harvesting under certain conditions.
- Where harvesting adjacent to a Class 1, 2 or 3 streamside reserve is planned, the boundaries of the streamside reserve will be clearly marked before harvesting commences.
- Trees should not be felled into a streamside reserve. Where this accidentally occurs the head should be pulled clear unless unacceptable damage to the reserve is likely to occur. Damage to vegetation, in particular mature myrtles, should be avoided.
- Trees should be felled away from Class 4 watercourses and damage to understorey vegetation should be minimised.
- Tractors or other harvesting machinery will not enter streamside reserves except at designated watercourse crossings, unless machines such as excavators are specifically approved by a Forest Practices Officer to carry out salvage or restoration works in dry conditions (e.g. removal of slash from watercourses following windthrow).
- Harvesting slash will not be pushed into streamside reserves (including machinery exclusion zones on Class 4 watercourses), and slash heaps should be sufficiently separated from reserves to reduce the risk of burning the reserves.

- Trees within streamside reserves will only be fallen where authorised in a Forest Practices Plan for road construction (see Section B3.1, page 12), snig track crossings of Class 3 watercourses, or for selective harvesting as described below:
  - the trees to be fallen will be marked by a Forest Practices Officer;
  - harvesting will take place in dry conditions;
  - the trees can be felled without falling into the watercourse, or significantly damaging retained trees;
  - no harvesting machine enters the streamside reserve for the purposes of the selective harvesting operation;
  - not more than 30% of the canopy will be removed;
  - trees will not be felled in the 10 m adjacent to a Class 1 or 2 watercourse;
  - the selective harvesting is not within 2 km upstream of a town water supply intake;
  - damage to mature myrtles will be avoided;
  - such harvesting is not likely to result in unacceptable substantial windthrow.

- Where specifically authorised in a Forest Practices Plan, excavator type feller bunchers (i.e. C3 machinery – see Table 4, page 30) with approved operators that can directionally fall trees may enter to within 5 m of a Class 4 watercourse under the following conditions:

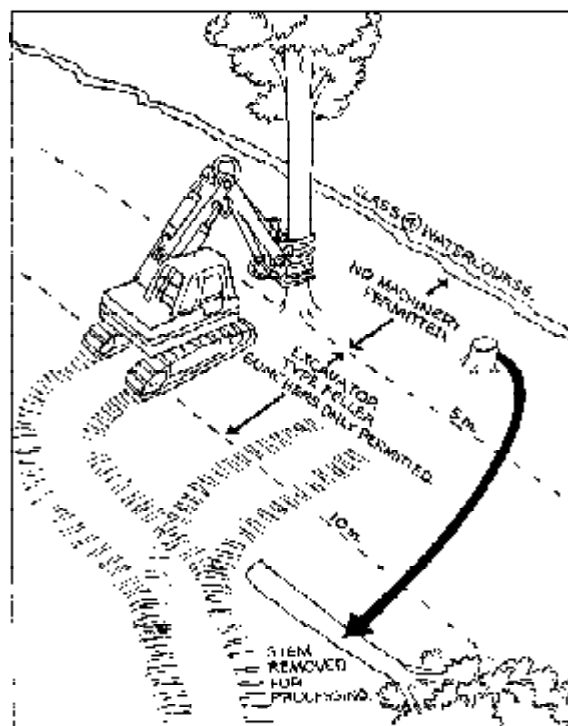

- where slopes are less than 20°, and soils are in the low to moderate-high erodibility classes;
  - when soils are dry, and where disturbance to the understorey and ground surface are minimised;
  - trees will, wherever practicable, be felled away from watercourses;
  - the machine will move in and out of the machinery exclusion zone by the same path without slewing the machine's tracks;
  - stems will be removed for processing to a site at least 10 m from the streambank;
  - all other machinery will be excluded from the machinery exclusion zone except at designated crossing points.
- Class 4 machinery exclusion zone boundaries should be marked where there is dense undergrowth and/or where the watercourse is difficult to define. They will be marked where excavator type feller bunchers are permitted to enter to within 5 m of a streambank. Responsibility for such marking will be stated in the Forest Practices Plan.

## C4.2 Plantation Streamside Reserves

### General Principle

- Watercourse protection measures will need to be carefully considered in Forest Practices Plans, taking account of past plantation establishment practices and the limitations applying to the future harvesting of plantations.

### Basic Approach

(This section applies to harvesting of plantations where land has been planted within streamside reserves and Class 4 machinery exclusion zones.)

- On low to moderate-high erodibility class soils, plantations may be harvested in streamside reserves and within 10 m of Class 4 watercourses subject to the following conditions:
  - no trees are to be harvested within 10 m of a Class 1, 2 or 3 watercourse for plantations established after the commencement of this edition of the Code;
  - in other situations:
    - excavator type feller bunchers (i.e. C3 machinery – see Table 4, page 30) may enter to within 5 m of a streambank provided slopes are less than 20°;
    - harvesting will only be carried out when soils are dry, or provided measures are taken to minimise soil disturbance;
    - trees will, wherever practicable, be felled away from watercourses;
    - the machine will move in and out of the machinery exclusion zone by the same path without slewing the machine's tracks;
    - remnant native vegetation will be retained;
    - stems will be removed for processing to a site at least 10 m from the streambank;
    - other harvesting machinery will not enter within 10 m of the streambank except at designated crossing points or to remove substantial harvesting debris;
    - where this approach is used the 10 m machinery exclusion zone will be marked, and responsibility for marking stated in the Forest Practices Plan;
    - outrow thinning across Class 4 watercourses may be carried out in accordance with Section C3.1 (see page 39).

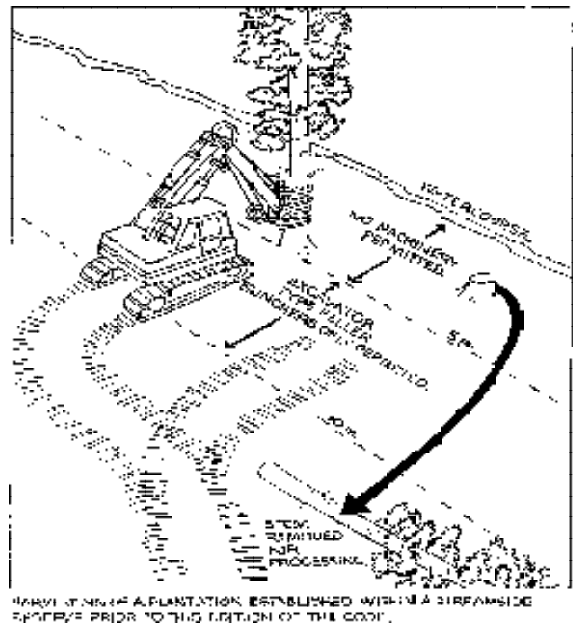

- On high to very high erodibility class soils the Forest Practices Officer will include additional measures to those above in the Forest Practices Plan as considered appropriate.
- Selective harvesting or the felling of the planted streamside reserve at a different time to the remainder of the coupe should be considered on sensitive sites.
- Woody debris is important for the health of aquatic ecosystems. However, harvesting debris which results in altered watercourse conditions should be kept out of watercourses. Substantial harvesting debris accidentally lodged in Class 1, 2 or 3 or permanently flowing Class 4 watercourses should be removed where authorised by a Forest Practices Officer causing as little damage as possible to the streambank and reserved vegetation. Machinery will not enter a watercourse during this process.

### C4.3 Swampy Ground and Surface Seepage Areas

#### Basic Approach

- Machines will not be taken within 10 m of the border of any swamp or area with obvious surface seepage except at properly corded crossing points. Where swamp or surface seepage areas are ill-defined, the edges should be marked prior to the commencement of operations.
- Seepage areas may require additional upslope protection to prevent sediment entering watercourses.

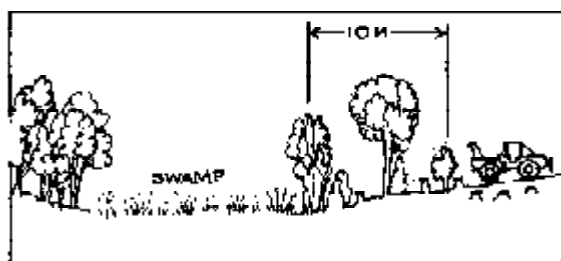

WHERE POSSIBLE EXCLUDE MACHINERY FROM JAN SHAPED AREA UPSLOPE FROM SEEPAGE AREA.

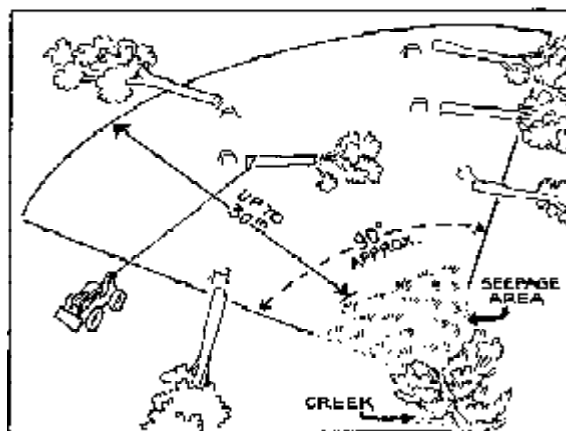

- Conventional harvesting in production swamp forests (e.g. blackwood swamps) should be in dry conditions. Additional provisions may also be prescribed by the Forest Practices Officer.

### C4.4 Water Supply Catchments

#### Basic Approach

- Clearfelling will not be permitted within 50 m of a bank of a Class 1, 2 or 3 watercourse and harvesting will not be permitted within 10 m of a Class 4 watercourse for a distance of 2 km upstream from a town water supply intake, unless approved by the local government authority in whose area the intake is located.
- No more than 5% of a town water supply catchment should be felled annually. See also Section D2.2.

## **C5. Salvage Operations**

### **General Principle**

- Special conditions will relate to salvage operations such as harvesting of proposed lake storage areas and farm dams, willow removal from streamside reserves, and harvesting associated with severe windthrow or fire damage.

### **Basic Approach**

- The operation will be considered in two sections:
  - for that part of the operation outside the salvage area the Forest Practices Code will apply;
  - for that part of the operation within the salvage area the Chief Forest Practices Officer may exempt operations from the provisions of the Forest Practices Code, but will prescribe alternative provisions in the Forest Practices Plan.
- Forest Practices Officers will require confirmation that dam planning and construction approvals have been obtained from DPIWE (where required) before certifying salvage operations within storage areas for new dams.
- Plans for salvage operations should include requirements for revegetation. See References <sup>7</sup> for approaches to restoring riparian vegetation.

## **C6. Steep Country Harvesting (Slopes 20<sup>0</sup> and Above)**

### **General Principles**

- Cable harvesting generally results in less soil disturbance and impact than ground based snigging in similar conditions.
- Under certain soil conditions (e.g. wet low load bearing soils, highly erodible soils) and where clearfelling is not constrained for other reasons, cable harvesting should be the preferred harvesting technique.
- The following provisions in this section of the Code pertain particularly to steep country forest operations on slopes of 20° and above. Other relevant provisions of this Code apply independent of slope.

### **Basic Approach**

#### ***Landslide Threshold Slopes***

- Areas with slopes greater than the threshold slope angle for the particular rock type as shown in Table 7, page 54 will be assessed for landslide hazard by a soils or other geotechnical specialist before harvesting can proceed.

#### ***Slope Limits for Cable Harvesting in Relation to Soil Erodibility Classes***

- As per Harvesting Machinery Guide ( Table 5, page 32).
- Plantations established on majority slopes steeper than the slope limit in Table 5 and the

landslide threshold slope angle in Table 7, page 54, can be harvested subject to written approval by the Chief Forest Practices Officer.

### ***Slope Limits for Conventional Harvesting***

- As per Harvesting Machinery Guide ( Table 5, page 32).

### ***General***

- Clearfell coupes with more than 50% of their area on slopes greater than 20° will be no greater than 50 ha in area unless approved by the Chief Forest Practices Officer in order to achieve safe burning boundaries or other specific reforestation requirements.
- Clearfell coupes will be dispersed by ensuring that, at the time of harvesting, adjoining unharvested or regenerated forest has a dominant height of at least 5 m at an acceptable stocking standard.
- Logs will not be pulled through native forest streamside reserve vegetation of Class 1, 2 or 3 watercourses. Cables may be pulled through this streamside vegetation but will not be dragged laterally across if unacceptable damage to the streamside reserve vegetation will result (see diagram C5, page 31).
- Where practicable understorey vegetation should be retained and disturbance minimised adjoining Class 4 watercourses and seepage areas. All trees to be harvested should, where practicable, be felled away from Class 4 watercourses.
- Cable draglines (roads) which are rutted to a depth of more than 200 mm below ground level for a distance of 20 m or more, should be water barred or gripped at maximum intervals of 20 m.

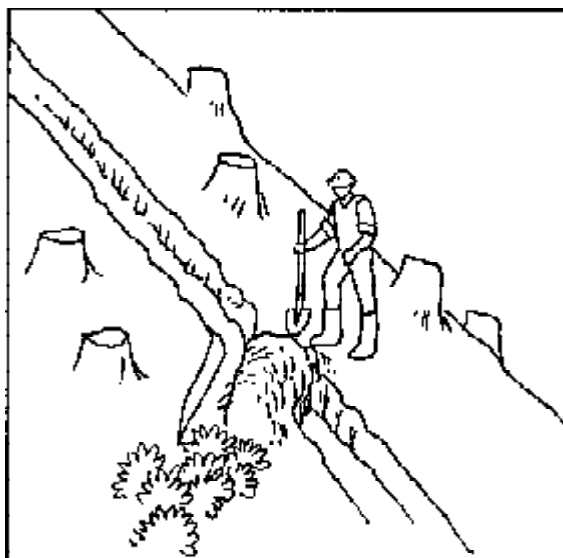

- The restoration provisions for conventional harvesting described in Section C3.2 also apply to cable draglines.

## D. CONSERVATION OF NATURAL AND CULTURAL VALUES

### General Principles

- The forest practices system contributes to the conservation of natural and cultural values at State and regional levels. Such values can occur in forest and non-forest environments.
- Conservation of environmental diversity (biodiversity, including flora, fauna, threatened species, and genetic resources; landscape; cultural heritage; and geodiversity, including soils and landforms;) will be principally catered for in a systematic reserve system on public land, by a voluntary private land reserve system, and by management prescriptions in production forests.
- Natural and cultural values in adjacent reserves should be considered during the planning and conducting of forest operations.
- Management of natural and cultural values should be integrated where possible.
- Resource manuals <sup>3,8-17</sup> and other available information on flora, fauna, threatened species, cultural heritage, geomorphology, landscape and soils will be consulted where appropriate.
- The main provisions dealing with the conservation of natural and cultural values are detailed below. Numerous other provisions in this Code affect these values, but have not been repeated in this section.
- Measures taken to conserve natural and cultural values will be consistent with effective fire management, silvicultural practices and safety requirements.

### Basic Approach

- Natural and cultural values should be assessed at the strategic or property level, and will be evaluated during the preparation of Forest Practices Plans.
- Requirements for the conservation of natural and cultural values, including specific sites, should be recorded to aid in future decision making and ensure continuity of management.
- Areas of high conservation significance may be designated as special management zones where there is agreement with the landowner. Forestry operations in special management zones will comply with the agreed management recommendations to ensure maintenance of natural and cultural values. Advice should be sought from an appropriate specialist before conducting any forest operations.
- The sustainable management of natural and cultural values within production forests under the forest practices system will be determined in accordance with:
  - relevant legislation, including the *National Parks and Wildlife Act 1970*, *Threatened Species Protection Act 1995*, *Aboriginal Relics Act 1975*, *Forestry Act 1920*, Commonwealth *Environment Protection and Biodiversity Conservation Act 1999*, and State Policies;
  - the Tasmanian Regional Forest Agreement 1997 (including the provisions for the Comprehensive Adequate and Representative reserve system);
  - the policy for maintaining a Permanent Forest Estate;
  - policy mechanisms that relate to State forest;



- the duty of care of landowners under the provisions of this Code, which is defined as the fundamental contribution of the landowner to the conservation of natural and cultural values that are deemed to be significant under the forest practices system. The landowners duty of care includes:
  - all measures that are necessary to protect soil and water values as detailed in this Code;
  - the reservation of other significant natural and cultural values. This will be at a level of up to 5% of the existing and proposed forest on the property for areas totally excluded from operations. In circumstances where partial harvesting of the reserve area is compatible with the protection of the values, the level will be up to 10%. The conservation of values beyond the duty of care is deemed to be for the community benefit and should be achieved on a voluntary basis or through compensation mechanisms where available.

## D1. Soils

### General Principles

- Proper care of forest soils is fundamental to sustainable forestry.
- Forest operations should not result in a significant deviation from natural rates of erosion and landslides.
- Forest soil care involves the control and prevention of unacceptable rates of erosion, nutrient loss, and landslides and of excessive compaction, puddling and mixing of topsoils and subsoils, during and after forest operations.

### Basic Approach

- During planning for forest operations consideration will be given to the erodibility, load bearing capacity, depth and susceptibility to soil nutrient loss and landslides of different soil types.

### Soil Erodibility

- Five classes of soil erodibility are used in this Code: low, moderate, moderate-high, high and very high (see Appendix 6).
- Erodibility classes for commonly occurring Tasmanian soils are given in *Forest Soils of Tasmania*<sup>8</sup>, and in detailed soil reports. In the absence of more detailed information erodibility classes can be estimated by using Tables 1 and 2 in the *Forest Soil Conservation Manual*<sup>9</sup>. A soils specialist should be consulted if the erodibility class cannot be determined from published information.
- The actual erosion risk (or hazard) on any site is related to soil erodibility combined with soil depth and site factors such as slope and rainfall intensity.
- Soils with high or very high erodibility or having a high erosion hazard require particular care. A specialist should be consulted during preparation of Forest Practices Plans on these soils. Refer also to Appendices 3 and 4.
- In karst areas, soil can be eroded directly downward into subsurface drainage channels

without surface runoff occurring, causing progressive and potentially total soil loss, or sometimes, accelerated sinkhole formation. Subsurface drainage directions in karst may be different to those suggested by topographic maps or observations on the surface. Subsurface drainage should be assessed before any forest operation occurs in a karst area or its catchment.

### ***Load Bearing Capacity***

- Poorly drained soils which when near saturation lose soil structure and strength and are prone to slurring and puddling e.g. soils in swamps, peats, deep clays and deep silts.

### ***Soil Depth***

- The impact of erosion is often most severe on shallow soils, especially if these soils have a planar rock contact (e.g. soils on “slab” dolerite or limestone).

### ***Susceptibility To Nutrient Loss***

- In order to conserve nutrients burning on very high erodibility soils will be limited as per Appendix 3. Where forests are being managed on short rotations consideration should be given to retaining slash on site, and to limiting burning, particularly on soils with moderate-high or high erodibility.

### ***Susceptibility To Landslides***

- Table 7 below presents acceptable threshold slope angles for soils developed on various rock types which are known to be susceptible to landslides. Areas with slopes greater than the threshold slope angle will be assessed for landslide hazard by a soils or other geotechnical specialist before operations can proceed under a Forest Practices Plan. A specialist should be consulted if unusual landform features such as hummocky ground, seepages or evidence of shallow subsurface drainage through the soil (e.g. intermittent disappearance of small water flows and minor collapse holes) occur.

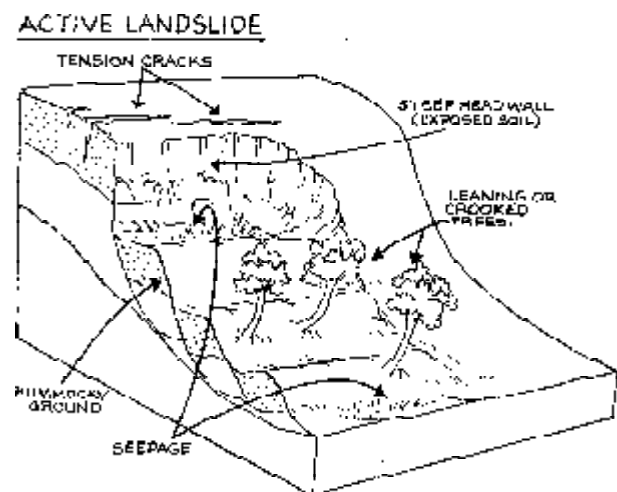

- Other rock types, not shown in Table 7, and slopes below the threshold, may be subject to landslides. Where such landslides have occurred, these occurrences will be reported to the Chief Forest Practices Officer and the area assessed for landslide hazard.
- Landslide hazard assessment is particularly important in planning road routes.

**Table 7. Landslide Threshold Slope Angles**

Age	Rock Type <sup>(1)</sup>	Threshold Slope Angle
Quaternary	Colluvium	15°
	Dolerite Slope Deposits (Talus) <sup>(2)</sup>	19°
	Basalt Slope Deposits (Talus) <sup>(2)</sup>	15°
	Landslide Debris	11°
	Fluvioglacial Deposits, Till	15°
Tertiary	Clay, Sandy Clay, Lignite	11°
	Basalt	19°
Triassic	Basalt	19°
	Mudstone, Siltstone, Shale	15°
	Coal, Coal Measures	15°
	Carbonaceous Mudstone	15°
Permian	Mudstone, Siltstone	15°
	Micaceous Shale	15°
	Carbonaceous Shale and Mudstone	15°
	Coal, Coal Measures	15°
Cambrian	Volcanics and Greywacke	19°
Precambrian	Phyllite, Schist	19°
<b>Note:</b>		
1. Age and parent rock type as used on the relevant geological maps.		
2. Refer to <i>Basalt and Dolerite Slope Deposit Guidelines</i> <sup>10</sup> .		

## D2. Water Quality and Flow

### General Principles

- Management will be consistent with the State Policy on Water Quality Management.
- Water quality and flow are affected by natural factors such as annual rainfall regime; vegetation types, cover and age; geology and geomorphology; soil type and exposure; topography; wildfires; and storm events; and by human actions such as road construction and maintenance, timber harvesting, reforestation, land clearing, dam construction and chemical use.
- Maintenance of acceptable water quality and flow and catchment and channel stability is of major concern and should be considered at the catchment and operational level.

## D2.1 Watercourse Protection

### General Principles

- All watercourses require protection during forest operations. The type of protection required depends on the nature of the catchment, size and permanence of the watercourse, the volume of water carried, and any natural and cultural values present.
- Water quality, catchment and channel stability, and biodiversity in aquatic ecosystems can be protected by minimising disturbance to watercourse channels and riparian (streamside) zones, and by reducing soil disturbance in and near watercourses. Potential downstream impacts also need to be considered.

### Basic Approach

- Native vegetation will be retained intact in Class 1, 2 and 3 streamside reserves as defined in Table 8 below, subject to other provisions in this Code permitting watercourse crossings and selective harvesting under certain conditions.
- Streamside reserves in plantations will be subject to the conditions in Sections C4.2, page 47 and E1.2.2, pages 81-84.

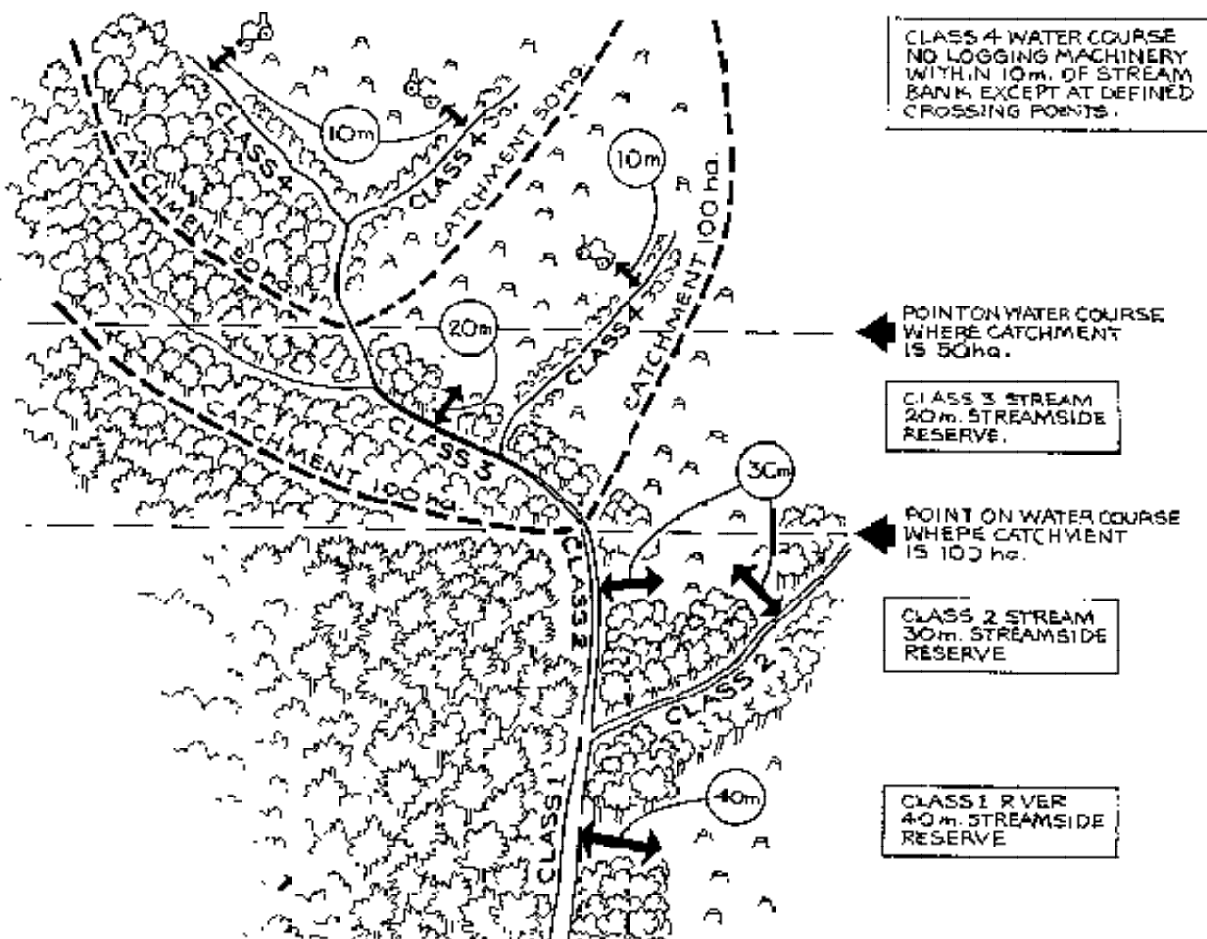

**Table 8. Minimum Streamside Reserve Widths or Machinery Exclusion Zones**

Watercourse Type	Minimum <u>horizontal</u> width from watercourse bank to outer edge of reserve
Class 1. Rivers, lakes, artificial storages (other than farm dams) and tidal waters <sup>(1)</sup> - generally those named on 1:100,000 topographical series maps.	40 m
Class 2. Creeks, streams and other watercourses from the point where their catchment exceeds 100 ha. <sup>(2)</sup>	30 m
Class 3. Watercourses carrying running water most of the year between the points where their catchment is from 50 to 100 ha. <sup>(2)</sup>	20 m
Class 4. All other watercourses carrying water for part or all of the year for most years. <sup>(3)</sup>	Machinery exclusion zone: - no machinery within 10 m of streambanks except as below. <sup>(4)</sup>
<p><b>Note:</b></p> <p>1 Taken to be within 40 m of the high tide mark of tidal waters.</p> <p>2 All catchment areas are to be confirmed on a 1:25,000 map prior to classifying watercourses. In upper catchments the Forest Practices Officer will assess the boundary between Class 1 and 2 watercourses based on local catchment conditions.</p> <p>3 A Class 4 watercourse is differentiated from a drainage depression (see Glossary) by having at least one of the following features:</p> <ul style="list-style-type: none"> <li>• a gravelly, pebbly, rocky or sandy bed, indicative of flowing water;</li> <li>• an obvious gully;</li> <li>• a short steep section of streambank adjacent to the watercourse bed.</li> </ul> <p>A Class 4 watercourse will often have a change in understorey vegetation from the streambank to the surrounding forest e.g. riparian/moist vegetation on streambanks – ferns, mosses, sedges.</p> <p>4 Harvesting machinery is permitted within 10 m under certain conditions at defined crossing points, and to undertake thinning (see Section C3.1). Conditions for the use of feller bunchers operating inside Class 4 machinery exclusion zones are detailed under Section C4. Site preparation machinery is permitted within 10 m under conditions detailed in Section E1.2.2.</p>	

- Class 4 watercourses may be upgraded to Class 3 by a Forest Practices Officer depending on local site conditions, particularly in eastern parts of Tasmania prone to high intensity rainfall.

- Wider streamside reserves, including reserves on Class 4 watercourses, should be specified in Forest Practices Plans where necessary to protect:
  - significant recreational, water supply, landscape, habitat or conservation values (in particular threatened aquatic species, relict rainforest and karst);
  - apiary resource (for example dense leatherwood stands);
  - significant myrtle gullies at risk from myrtle wilt;
  - local soil types with high or very high erodibility;
  - fish spawning or nursery areas;
  - areas at significant risk of windthrow;
  - steep areas (over 20°) on rock types where the landslide threshold angle is exceeded.
- Watercourse classifications will not be downgraded where there is a loss of water underground into subsurface conduits including karst streamsinks or slope deposits.
- Significant springs will be treated as Class 3 or 4 watercourses. Subsurface conduits emerging as springs may require extra protection upslope e.g. extension of machinery exclusion zones.
- Interpretations on watercourse classifications and appropriate streamside reserve widths should be sought from the relevant specialist when considered necessary.

## **D2.2 Water Supply and other Significant Catchments**

### **General Principle**

- In town water supply, domestic water supply and freshwater aquaculture facility catchments, and catchments important for threatened aquatic fauna, particular attention to soil and water care is needed. Planning will be directed to minimising as far as is practicable the percentage of the catchment harvested, roaded, or established to plantation in any one year.

### **Basic Approach**

- Town water supply and freshwater aquaculture facility intakes are listed in Appendix 2. Catchment areas corresponding to town water supply intakes will be identified in Forest Practices Plans.
- Additional watercourse protection by enlarged streamside reserves or other measures may be specified by a Forest Practices Officer.
- Within 2 km upstream of a town water supply intake or freshwater aquaculture facility intake specific prescriptions will be placed in Forest Practices Plans, (and will be considered for catchments which are important for threatened aquatic fauna), regarding:
  - timing of harvesting, plantation establishment and roading;
  - use of chemicals;
  - wet weather limitations;
  - camps or living quarters;
  - methods of road construction, especially watercourse crossings (see Section B8);
  - management of fuel, grease and oils (see Section F).

- Revegetation or other methods of surface protection of areas of bare soil on road batters, borrow pits, landings and snig tracks will be specified in the Forest Practices Plan as required by the Forest Practices Officer.

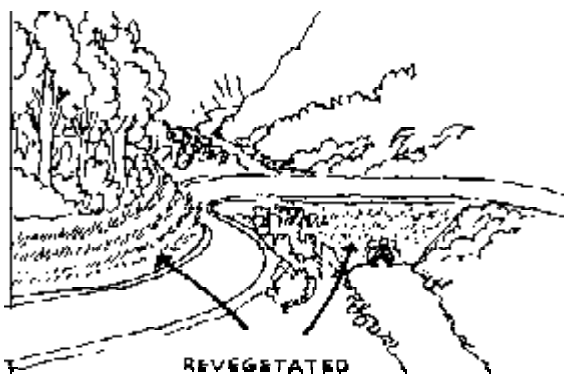

- Within 2 km upstream of known domestic water intakes measures in addition to the standard provisions of this Code may be prescribed in the Forest Practices Plan. In particular, measures may be required where a domestic water supply is derived wholly or predominantly from within an area of forestry operations. Consult with a specialist if disturbance is likely to significantly affect water quality.

### **D3. Flora and Fauna**

#### **General Principles**

- Conservation of flora and fauna is assisted by the maintenance and restoration of habitat, the enhancement of opportunities for recolonisation of disturbed areas, and the linking of forest areas to allow genetic interchange.
- Maintenance of the genetic resources of native forest is assisted by the retention of native flora and fauna in formal and informal reserves including wildlife habitat strips and streamside reserves dispersed throughout the forest, and the use of seed sources native to the site when regenerating forests. Generally, retention of forest with oldgrowth characteristics is preferable to retention of regrowth of the same forest type.

#### **Basic Approach**

- Planning for flora and fauna conservation should initially be carried out at a regional level (e.g. whole property, forest block or district forest management plan). At this level:
  - strategies should be developed to maintain species diversity, particularly in extensive plantation areas and other intensively managed areas;
  - dispersed coupes should be considered;
  - management agreements should be considered between the landholder and DPIWE for threatened species, particularly those with a restricted range.

- As far as practicable, areas of retained vegetation (including wildlife habitat strips – see page 62) should include localised features associated with:
  - threatened species;
  - species with disjunct or unusual distributions;
  - sites with high species diversity;
  - inadequately reserved communities;
  - forests that have oldgrowth characteristics;
  - other significant biological values (e.g. important research sites).
- In parts of the State where native forests occur mainly as remnants, consideration will be given to:
  - retention of native forest remnants to aid in the maintenance of local flora and fauna diversity and landscape values;
  - restoration of habitat including widening and linking wildlife habitat strips, particularly where species and communities of high conservation significance are known to occur.

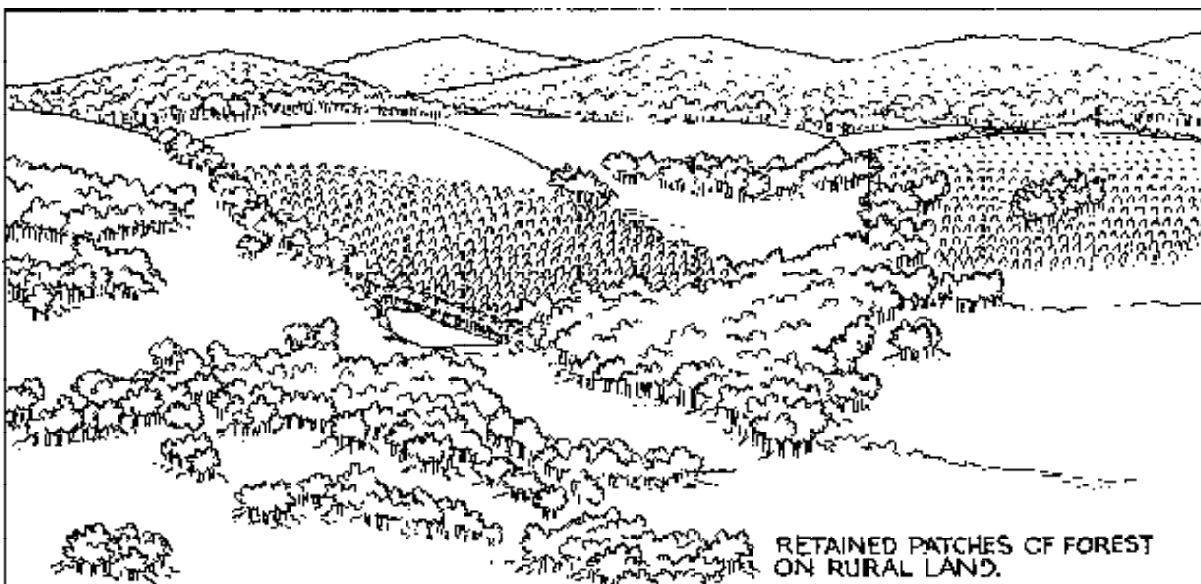

### D3.1 Flora Conservation

#### General Principle

- The general requirements and guidelines for conservation of significant flora values are outlined in the *Forest Botany Manuals*<sup>11</sup>. Other sources of information include vegetation maps, the flora databases held by Forestry Tasmania and DPIWE and advice from specialists.



## Basic Approach

### *Planning and Assessment*

- See also Section D3 above.
- Planning for broad areas of forest will require the consideration of the conservation requirements of plant communities and species, maintenance of values in formal and informal reserves, and other flora-related issues.
- During the preparation of a Forest Practices Plan the proposed operational area will be assessed to determine:
  - the plant communities present;
  - whether threatened plant species are known or likely to occur;
  - whether other significant flora values are known or likely to occur.

### *Site Management for Flora in Native Forests*

- Disturbance to native vegetation in localised environments (such as rocky knolls, swamps, heaths, and streambanks) should be avoided or minimised. These environments are associated with plant communities and species with a priority for conservation, and are important in maintaining diversity at a local level.

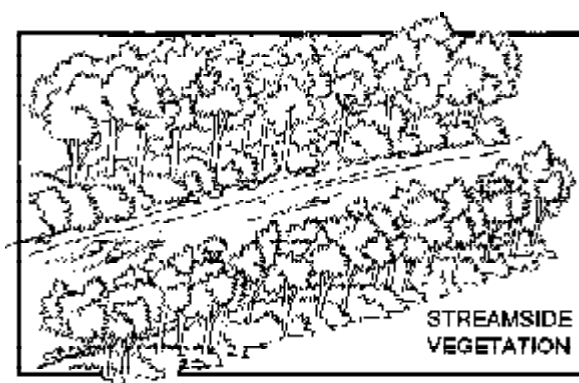
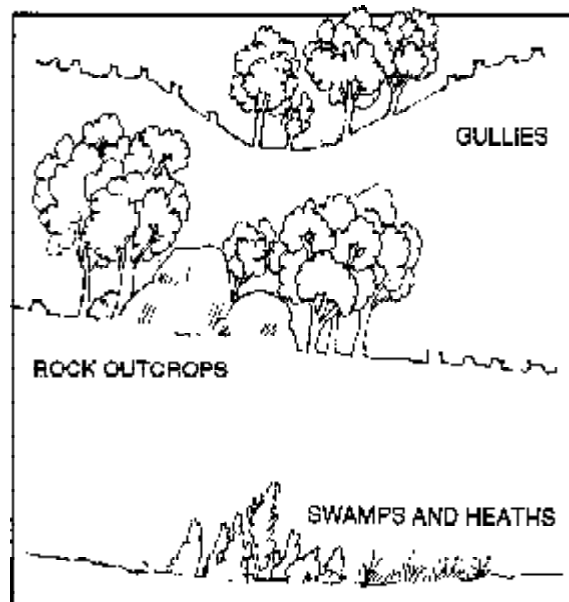

- Vegetation that is susceptible to *Phytophthora cinnamomi* (e.g. swamps, heaths, sedgeland, dry lowland forest on sandy or poorly drained sites, and low altitude rainforest on infertile sites), should be protected from accidental infection by the fungus by the implementation of hygiene measures.
- Patches of myrtle or rainforest that are to be retained should be protected from fire, damage and disease (notably myrtle wilt). This may require buffering of some patches (e.g. by extending streamside reserves) and avoiding or minimising damage during road construction or maintenance (see page 13).
- Measures should be taken to ensure exotic weed species, (e.g. pampas grass, ragwort, blackberry and Spanish heath), do not become established in native forest, particularly reserves. Native forest most at risk includes areas adjoining plantations, and drier forest types in general. Machinery should be washed down before being transported from one area to another, particularly when moving from infested to uninfested areas.
- Consideration should be given to the protection (e.g. by buffering) of native forests, particularly reserves, from incursion by adjoining plantation species. For example, dry forests may be invaded by radiata pine, and some planted eucalypts may hybridise with related species in adjacent native forest.
- Disturbance to localised environments rich in epiphytic species should be avoided or minimised, particularly in drier parts of Tasmania. Such environments include relict or oldgrowth rainforest, dense patches of musk or manferns and sheltered boulderfaces. If possible, trees should not be felled into or yarded across these environments, partly to reduce the volume of slash and consequently the intensity of regeneration burns. Epiphytic species will recover most rapidly on sites which are not subjected to high intensity burning.

## **D3.2. Fauna Conservation**

### **General Principles**

- Fauna conservation will be considered in all stages of forest management. In particular, the requirements of threatened species and communities, aquatic fauna and cave fauna will be addressed.
- Sources of information include the *Threatened Fauna Manual for Production Forests in Tasmania*<sup>12</sup>, *Threatened Fauna Adviser*<sup>13</sup>, technical notes<sup>14</sup> and specialist advice.

### **Basic Approach**

#### ***Planning and Assessment for Fauna***

- See also Section D3 above.
- During the preparation of a Forest Practices Plan the proposed operational area will be assessed to determine:
  - the known occurrences and potential habitat for threatened species;
  - the presence of or requirements for wildlife habitat strips;
  - the requirements for wildlife habitat clumps;
  - the presence of or requirements for special management zones for fauna.

A specialist will be consulted for advice where appropriate.

## Site Management for Fauna in Native Forests

- Wildlife habitat strips should be retained to maintain habitat diversity. As a guide, strips of uncut forest 100 m in width, based on streamside reserves but including links up slopes and across ridges to connect with watercourses in adjoining catchments, should be provided every 3-5 km. These strips should connect any large patches of forest which are not to be harvested, such as formal and informal reserves.

WILDLIFE HABITAT STRIPS IN NATIVE FOREST



- Patches of mature forest (wildlife habitat clumps) containing habitat trees with nesting hollows and other oldgrowth structural elements should be retained in coupes with few retained areas (e.g. streamside reserves, areas reserved for other values, areas reserved for operational reasons etc.). Retention of such wildlife habitat clumps assists maintenance of the habitat requirements of oldgrowth dependent fauna species, particularly hollow dependent fauna, and enhances recolonisation of areas following harvesting.

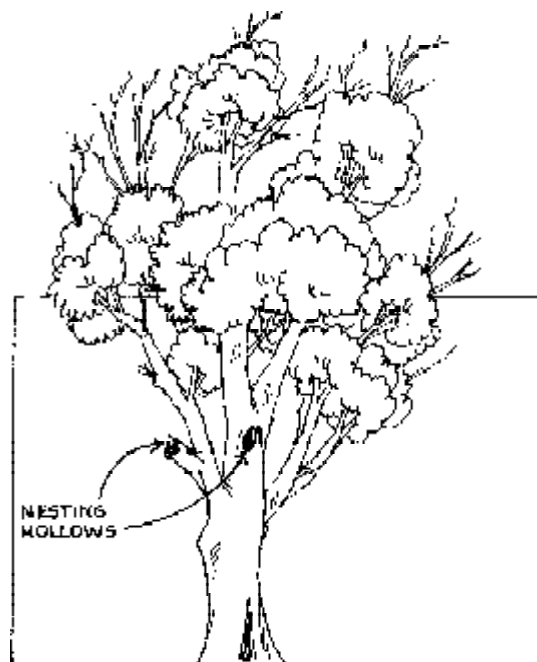

- Within coupes where no burning or low intensity burning is intended (mainly partially harvested coupes), wildlife habitat clumps should be retained in areas which are not within 200 m of other retained areas. Clumps should be retained at a rate of approximately 1 clump every 5 ha and should contain a minimum of 2 to 3 habitat trees and where possible a range of trees and shrubs of other ages.

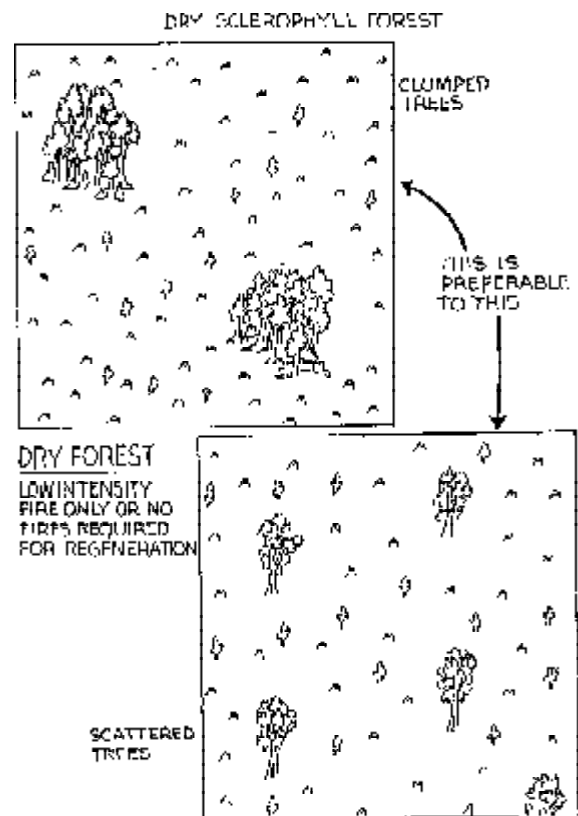

- In coupes where high intensity burning is required to achieve regeneration or where cable harvesting is used (mainly clearfell coupes), wildlife habitat clumps should be retained along the boundary of the coupe where they can be protected from disturbance. As a guide retain clumps at approximately 200 m intervals along a coupe boundary in areas not within 200 m of other reserved areas. These clumps should be about 50 m by 20 m in size. Consideration should be given to retaining adjoining clumps when adjacent coupes are felled.
- Consult *Fauna Conservation in Production Forests in Tasmania*<sup>15</sup> or other sources for more details.

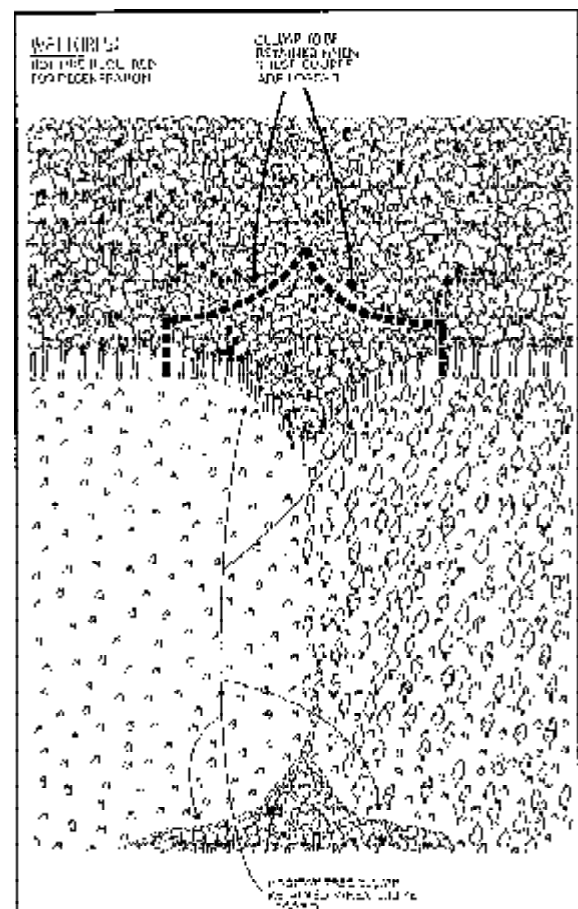

### D3.3 Threatened Species and Inadequately Reserved Plant Communities

#### Basic Approach

- Management of threatened flora and fauna species and inadequately reserved plant communities are covered by legislation and processes that include the Commonwealth *Environment Protection and Biodiversity Conservation Act 1999*, the Tasmanian *Threatened Species Protection Act 1995*, the *National Parks and Wildlife Act 1970*, and the Tasmanian Regional Forest Agreement 1997.
- Threatened species and inadequately reserved plant communities will be managed in wood production areas in accordance with procedures agreed between the Forest Practices Board and DPIWE. The agreed procedures will include the development of endorsed management prescriptions through consultation among landowners, Forest Practices Officers and specialists within the Board and DPIWE. Under the agreed procedures Forest Practices Officers will:
  - consult the *Forest Botany Manuals*<sup>11</sup>, the *Threatened Fauna Manual for Production Forests in Tasmania*<sup>12</sup>, and the *Threatened Fauna Adviser*<sup>13</sup> to determine if threatened species or inadequately reserved plant communities occur or are likely to occur in the operational area;
  - notify the appropriate specialist within the Forest Practices Board if threatened species or inadequately reserved plant communities occur or are likely to occur in the operational area;
  - obtain an endorsed management prescription for the operational area and incorporate this prescription into the Forest Practices Plan. This may involve further consultation between the Forest Practices Officer, the landowner, and specialists within the Forest Practices Board and DPIWE.
- The conservation of threatened species and inadequately reserved plant communities may be achieved by reservation or prescription in accordance with the duty of care policy, voluntary arrangements such as the Private Land Reserve Program, or through legislative processes as mentioned above.

## D4. Landscape

### General Principles

- Forest operations can be highly visible because of the hilly or mountainous nature of much of Tasmania, and can sometimes have long term impacts. Operations generally cannot, and need not, be hidden from view, but can be designed to reduce visual impact and harmonise with the local visual character and land use patterns.

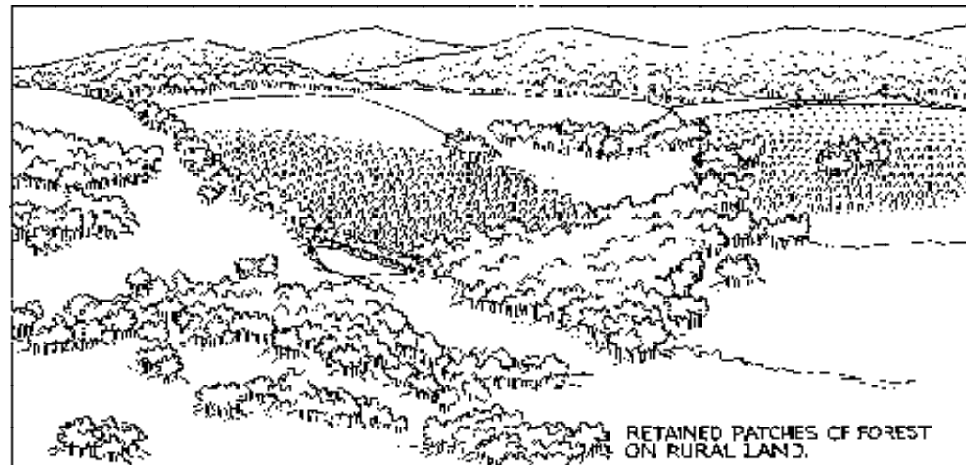

- Sources of information include *A Manual for Forest Landscape Management* <sup>16</sup>, mapped data and specialist advice.
- Visual Management Objectives, as set out in Chapter 2 of the *Manual* <sup>16</sup>, provide the visual standards that should be applied to management of forest operations.

### Basic Approach

- Planning for visual management is based on:
  - the Visual Management System and its major elements (i.e. public sensitivity, distance zones, and scenic quality), which define a rating of scenic importance (Landscape Priority Zones), and visual quality standards (Landscape Management Objectives);
  - broad viewfields within which the sequencing and timing of operations can be considered to constrain long term cumulative visual effects (this is especially relevant to steep country).

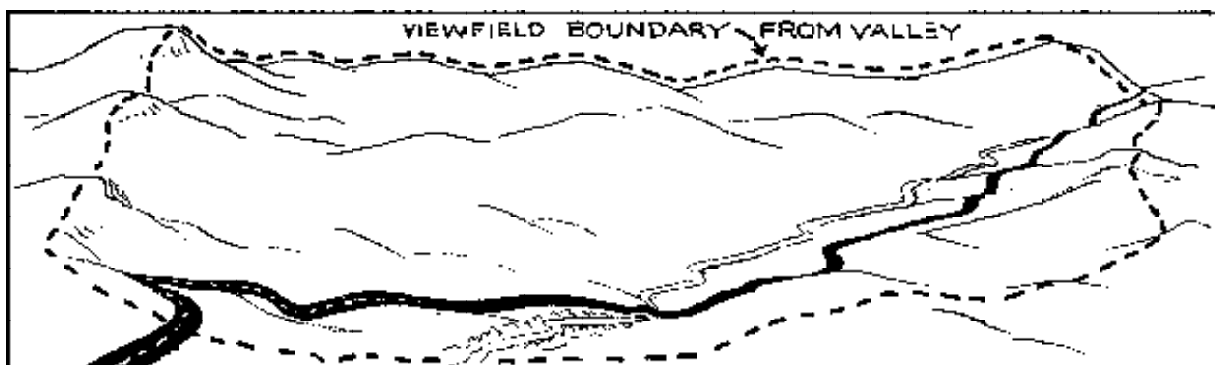

- Local government will be consulted regarding areas with landscape protection provisions in planning schemes, and due regard given to the provisions.

#### D4.1 Roads and Quarries

- Roads, including constructed cable landings, and quarries can impact on forest scenery and introduce long term changes. Exposed rock and subsoil often contrast in colour and brightness with surrounding forest.
- Roads and quarries in visually sensitive locations should be designed to limit their visual exposure. Large or continuous batters should be treated as soon as practicable, (e.g. with contrast reducing surface sprays or mulching and seeding), to reduce visual impact. Planting on fill slopes can be effective in providing rapid screening.
- Spur roads constructed through forest onto major tourist roads should, where safe and practical, have a dogleg bend, and the initial section should be as narrow as practicable. This will limit visual impact and reduce direct viewing into forest operations.

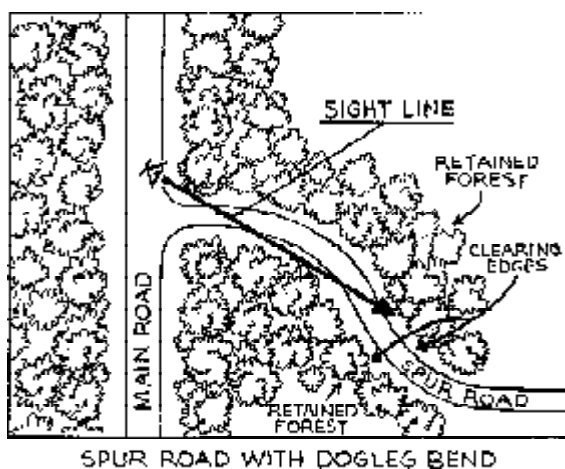

- Roads and fire breaks should not be directly aligned with major viewpoints. Adverse and enduring visual impact may be created if straight sections of roads in steep country are aligned to viewpoints.
- New quarries should be located and designed to limit their exposure to public viewing, and should include plans for progressive rehabilitation.

#### D4.2 Harvesting

##### *Harvesting Method*

- Partial harvesting systems should be used where appropriate, as these are less visually intrusive in the landscape.
- Clearfelling creates areas that have a strong visual contrast with surrounding forests. Specific visual analysis and design will often be necessary to limit visual impact, particularly in steep country.



### ***Coupe Size and Shape***

- The viewed shape and size of coupes planned for clearfelling should be guided by existing patterns and features seen in the surrounding landscape. These include land use and vegetative patterns as well as topographical aspects, especially ridges and drainage gullies.

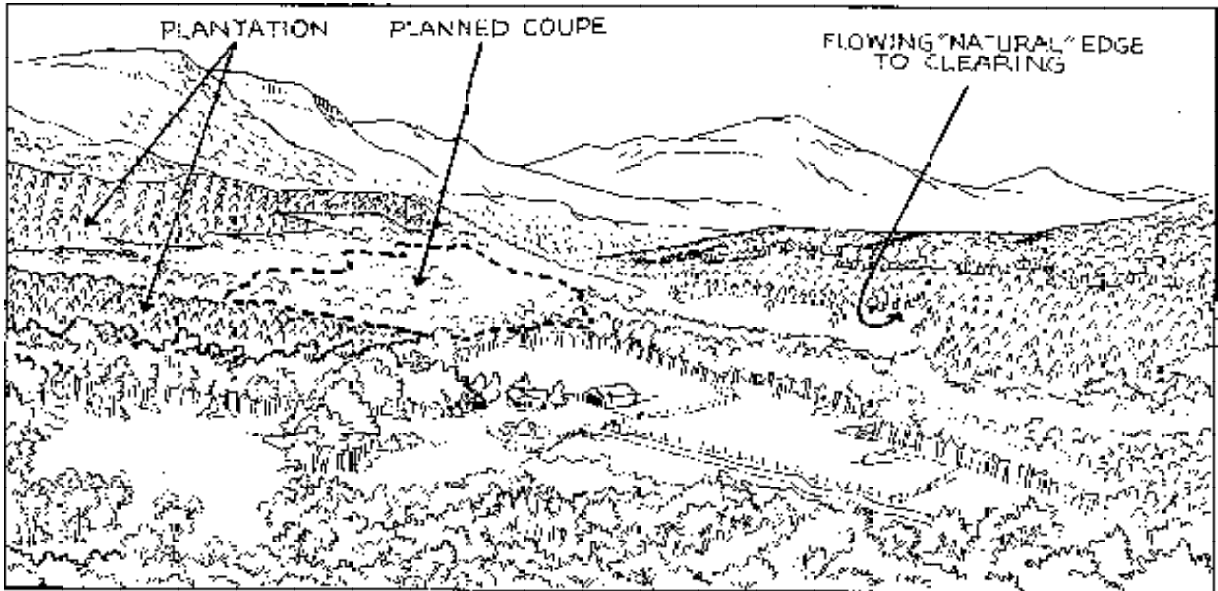

- Straight edges and box-like shapes should be avoided.

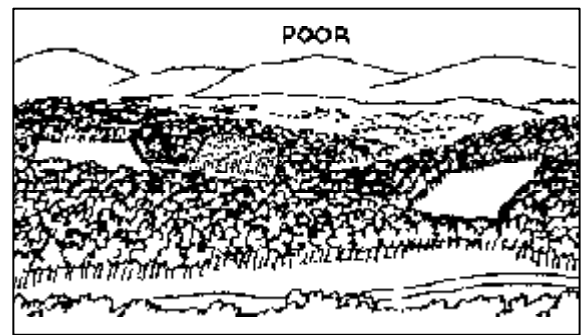
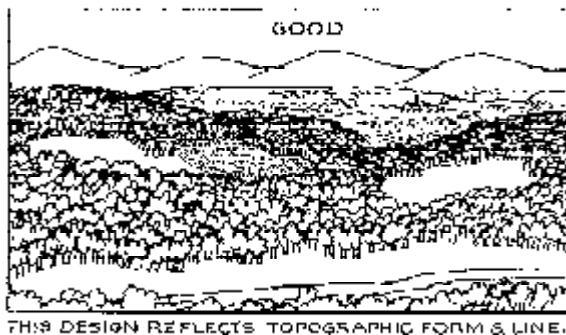



## Protection of Roadside Scenery along Scenically Important Roads

- Roadside vegetation is valuable for limiting the visual impact of forest operations. However, vegetation should generally be retained as clumps rather than in continuous strips, especially on the outside of road corners. Retained vegetation should be of sufficient width to ensure its long term survival.
- Where practicable, set landings back within the coupe and retain forest to reduce visual impact. (The safety risk of retained trees will also be considered in the planning and implementation of forest operations).

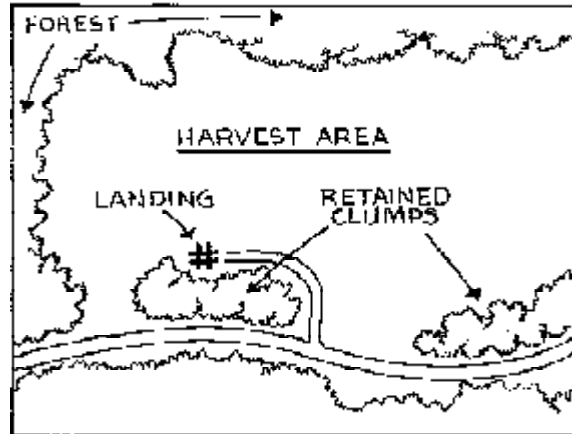

## Skyline Areas

- Forested skylines should be protected by designing coupe boundaries to cross at the toe of skyline slopes or in saddles. Boundaries should preferably cross diagonally to the main viewing direction.

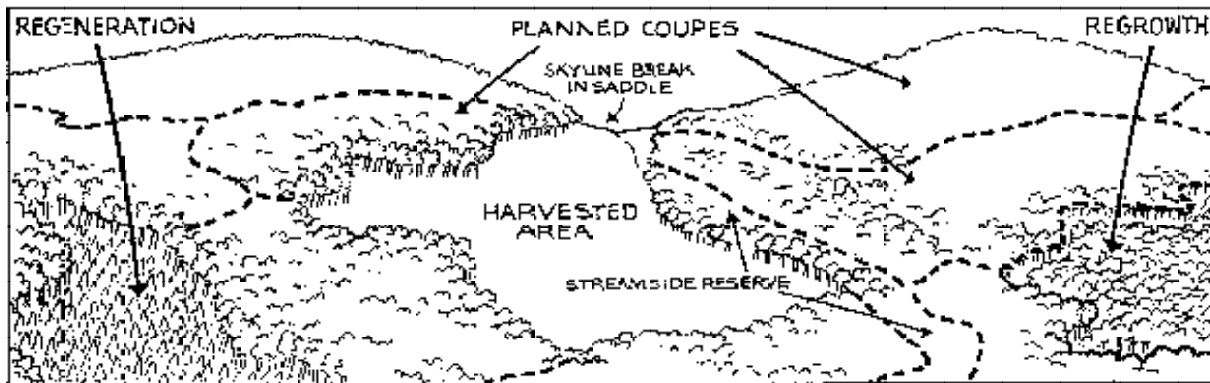

- An alternative to crossing a skyline is to locate coupe boundaries either behind or in front of the skyline edge.

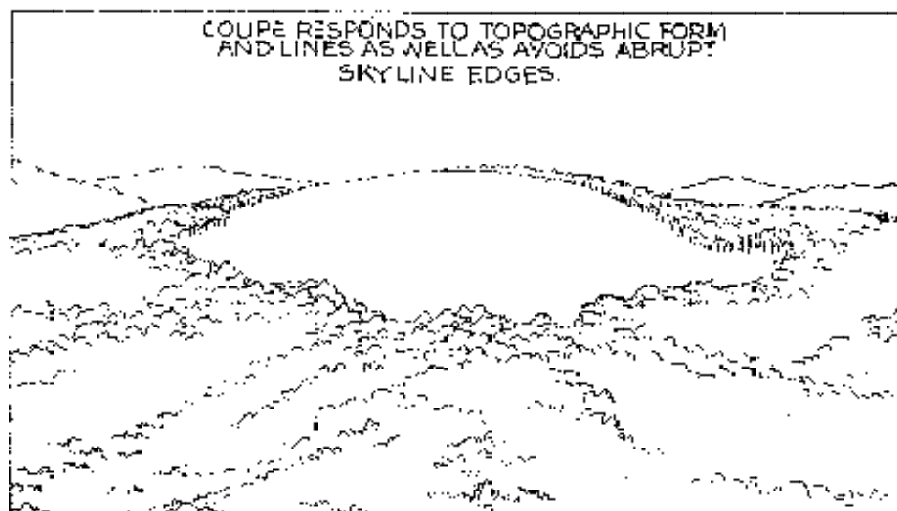

### Sequence and Timing of Cutting

- A mosaic of varying age classes, shapes and scale of coupes provides the best visual result. Coupes should be dispersed in time and space throughout the forest or viewshed to minimise the level of visual change from any viewpoint, particularly sensitive views from highways, lookouts, walking trails and townships.

### Steep Country (Slopes 20° and Above)

- In steep country, additional emphasis on the visual management of forest operations is required, due to the greater prominence and exposure of steep slopes, and their lower capacity to absorb operational changes.
- Operations will generally require detailed analysis to design visually desirable results. Advice should be sought from a specialist for all operations in Landscape Priority Zone A.

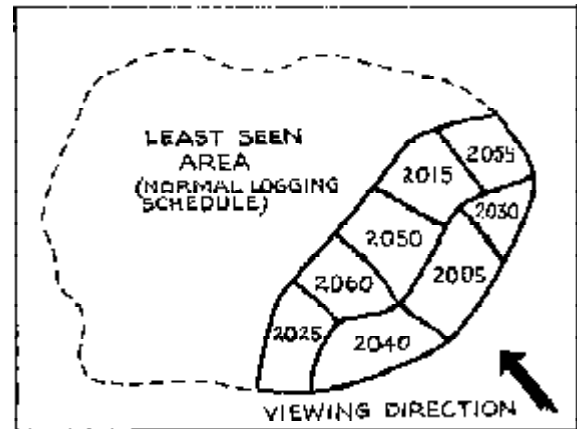

### D4.3 Plantation Development

- Plantation forestry is an intensive form of land use which can dramatically alter the character of the scenery, especially in rural areas. The visual prominence of plantations arises from contrasting colour with surrounding vegetation and or agricultural clearings; rectilinear boundaries; consistent canopy texture, growth and height; and short rotation periods. In addition, plantations are often visible to the public from highways and populated areas.
- To link plantations into the surrounding landscape, reduce their prominence, and maintain variety, it is visually desirable to:
  - design plantations that adjoin roads so that their boundaries do not parallel the road;

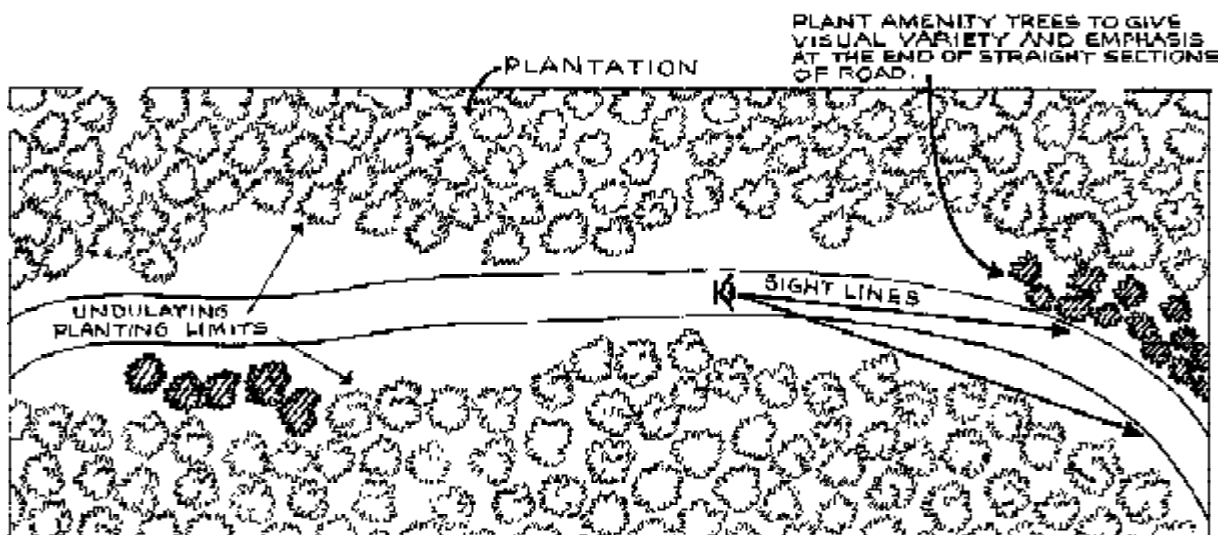

- retain native forest clumps and streamside vegetation or develop amenity plantings using native or exotic trees, especially at prominent locations along roads;
- avoid large areas being harvested in the same year;
- design plantations on hillsides so that they relate sympathetically to the topography as defined by watercourses and ridgelines;

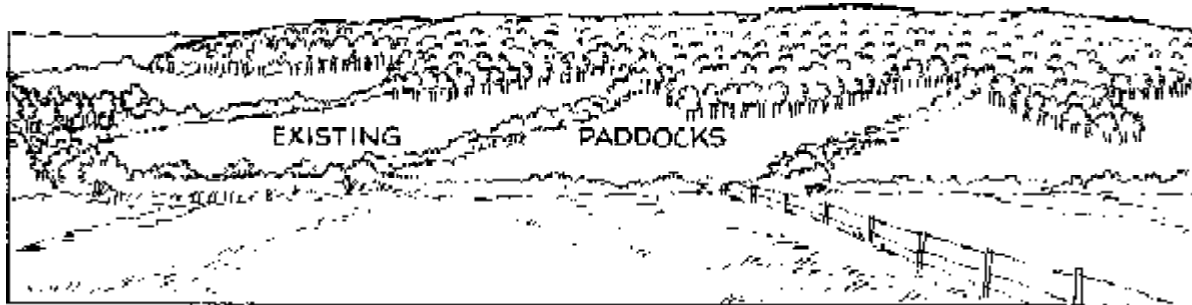

PLANTATION IN AGRICULTURAL SETTING

- use interlocking coupe shapes, sizes, and age classes, as well as scheduling to obtain spatial distribution within the landscape;
- locate plantations on the lower slopes rather than on the prominent upper slopes of hillsides.

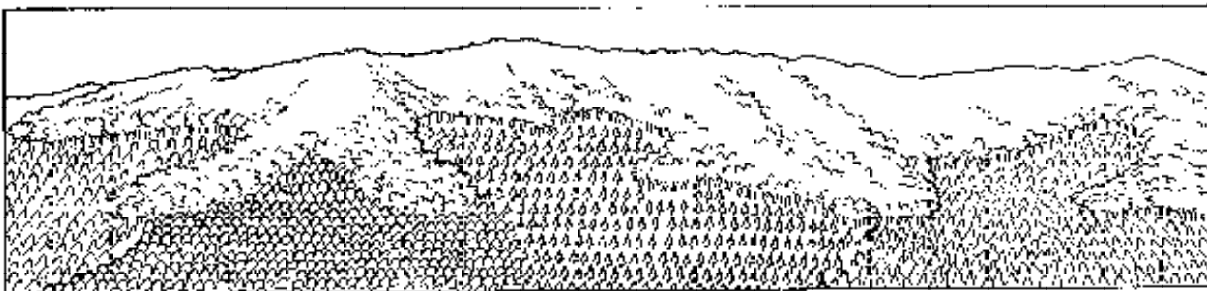

PLANTATION BOUNDARIES WITH INTERLOCKING SHAPES TO NATIVE FOREST ON SLOPES ABOVE

## D5. Cultural Heritage

### General Principles

- The cultural heritage of all ethnic groups (e.g. Aboriginal and other Australians) will be considered in all stages of forest management. The need for consultation with special interest groups is acknowledged.
- Protection of cultural heritage should be achieved through identification, recording and assessment, and subsequent management by prescription or reservation.
- Assessment of cultural significance and development of management prescriptions should involve cultural heritage expertise.

- Relevant legislation and processes, including those required under the *Aboriginal Relics Act 1975* and the *Historic Cultural Heritage Act 1995*, will be delivered through Forest Practices Plans in accordance with procedures agreed by the Forest Practices Board and other relevant agencies.
- Sources of information include the *Forest Practices Forest Archaeology Manual*<sup>17</sup>, site records, Archaeology Potential Zone maps, the potential zoning predictive statements and specialist advice.

## Basic Approach

### D5.1 Planning and Assessment

#### *Aboriginal Heritage*

- During the planning for broad areas of forest, areas of Aboriginal cultural heritage site potential and/or sensitivity should be identified using the Archaeological Potential Zone maps where available, or the potential zoning predictive statements in other areas. High sensitivity zone indicators are as follows:
  - any flat and relatively well drained land within 500 m of Class 1, 2, or 3 watercourses;
  - forested margins of heath, button grass or native grassland plains, marshlands, lakes or coasts;
  - areas with sandstone cliffs;
  - major continuous ridgelines;
  - natural river crossings in hilly areas;
  - karst areas;
  - mature stands of *E. gunnii*;
  - outcrops of quartz, fine grained quartzites, cherts, spongolite or chalcedony.
- Where sensitive areas are identified, surveys will be completed prior to the commencement of forest operations if site conditions are suitable.



- The type of survey to be undertaken will depend on environmental conditions and management requirements (see the *Forest Practices Forest Archaeology Manual*<sup>17</sup>).

#### *Historic Heritage*

- Relevant information on sites or areas of cultural heritage significance, or potential significance, should be recorded.
- Data reliability and site significance should be assessed by an archaeologist.

## General

- During the preparation of a Forest Practices Plan any known historic heritage sites and any Aboriginal potential zones and known sites will be identified. Specialist advice will be obtained in accordance with agreed procedures.
- Protection requirements will be listed in the Forest Practices Plan.

### D5.2 Site Management

- Site recording and management of Aboriginal cultural heritage will be in accordance with the *Aboriginal Relics Act 1975*.
- Significant historic heritage sites should be managed in accordance with specialist advice and, where applicable, the *Historic Cultural Heritage Act 1995*.
- In highly sensitive areas with poor ground surface visibility, monitoring during forestry operations should be undertaken.
- When any cultural heritage sites or features associated with them (e.g. rock overhangs, sawmill remains) are located during operations, a Forest Practices Officer will be notified. The site will be assessed and recorded prior to further disturbance.

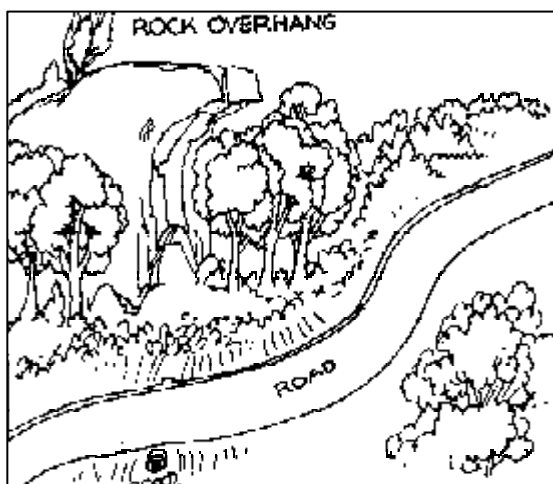

- Protection of significant sites should be achieved by maintaining confidentiality, management prescriptions such as physical protection works, changing the location of operations, reservation, or special management areas.

## D6. Geomorphology

### General Principles

- Geological, landform, and soil sites are important for their intrinsic, scientific, recreational, inspirational values, other uses, and the role geodiversity plays in sustaining natural processes.
- Survey, identification, recording, and assessment of geoconservation values should be carried out where appropriate prior to forest operations. Protection of significant landforms may be by means of management prescription or reservation.
- Geological sites, landforms and soil sites of significance vary in their vulnerability to damage.
- Sources of information include the *Geomorphology Manual*<sup>18</sup>, *Tasmanian Geoconservation Database*, *An Atlas of Tasmanian Karst*<sup>3</sup>, *Some Operational Considerations in Sinkhole Management*<sup>19</sup> and specialist advice, including speleologists for karst areas.

## Basic Approach

### D6.1 Planning and Assessment

- Areas of potential geoconservation significance should be identified from available sources.
- During preparation of a Forest Practices Plan the proposed operational area will be assessed for the following:
  - the presence of any significant landforms as listed in the *Geomorphology Manual*<sup>18</sup>;
  - if in a karst area, which karst categories (i.e. A, B, C or D) are present;
  - whether any post-operation management issues are likely to arise (e.g. easier public access to sensitive sites).
- A geomorphologist should be consulted for assessment of significance and management requirements in any of the situations above, or where:
  - Category A or B karst is present, or occurs within 5 km downstream;
  - sinkholes, caves, or sinking watercourses are present in Category C or D karst areas, or within 5 km downstream;
  - an area listed as sensitive in the Tasmanian Geoconservation Database may be affected.
- Forest Practices Plans will specify significant features for an area and the protection measures to be adopted.
- Refer also to provisions in other sections of this Code, particularly with regard to karst management. The technical note *Some Operational Considerations in Sinkhole Management*<sup>19</sup> will be consulted where appropriate.

### D6.2 Site Management

- Specialist advice should be sought in the following situations:
  - protection of significant examples of landforms in forested areas considered for harvesting may require a modification of harvesting operations or practices (e.g. partial exclusion, re-routing of roads);
  - confidentiality concerning certain types of sites may be necessary in order to secure their protection. The gating of roads or karst caves may be necessary where sensitive features have been made accessible by forest operations.

## E. ESTABLISHING AND MAINTAINING FORESTS

### General Principles

- Management will aim to conserve soil and water quality, maintain biodiversity and long term site productivity, reduce visual impact and protect other natural and cultural values. Prompt reforestation will contribute to the achievement of these aims.
- A range of low to high capital cost reforestation techniques may be applicable depending on the site and stand characteristics and the forest owner's objectives.
- All techniques will take account of how much tree cover is to be removed, what site preparation is required to promote growth and what will be the source of new growth i.e. seed, nursery plants or advance growth of seedling, coppice or lignotuberous origin.
- If seed based reforestation is used most native forest species require mineral soil, light and freedom from competing vegetation and browsing to grow successfully.
- All newly established forests will need monitoring and protection.
- Pests and diseases can adversely affect forest health. Owners of plantations, in particular, may need to seek advice on measures to protect their forests from pests and diseases.
- The natural fire frequency in riparian (streamside) forest is usually lower than non-riparian forest. An objective of fire management planning should be to avoid where practicable burning of streamside vegetation.

## E1. Reforestation

### E1.1 Planning

#### Basic Approach

- The person(s) or organisation responsible for reforestation will be listed in the Forest Practices Plan.
- The following factors will be considered and, where appropriate, detailed in the Forest Practices Plan (see the Selected Bibliography, page 104, for further detailed advice):
  - Nature of the Existing Forest
    - dominant forest type species
    - main understorey species
  - Site Factors
    - altitude, exposure
    - slope
    - dryness, rainfall
    - soil type, erodibility, depth
    - drainage
    - natural and cultural values

- Landowners Management Objectives
  - even-aged native forest
  - uneven-aged native forest
  - plantation
  - conversion to non-forest uses
- Reforestation Techniques
  - see Table 9, page 76
- Felling Standards
  - intensity (e.g. clearfell; 30% canopy retention)
  - distribution of remaining trees (e.g. number of seed trees/ha to be retained)
  - selection criteria (e.g. no trees below 50 cm diameter to be felled)
  - damage to retained trees
- Site Preparation Techniques
  - use of fire, mechanical heaping of debris, scarification of the soil, application of herbicides
- Regeneration Establishment
  - source of next crop (advance growth, sowing treatments or planting, seed source, species)
  - nature and timing of regeneration operations
- Protection of the New Crop
  - monitoring and browsing control
  - exclusion of domestic stock
  - fire protection
- Evaluation of Stocking
  - time of stocking assessment
  - stocking criteria to be applied

## **E1.2 Site Preparation Techniques**

### **General Principle**

- Site preparation techniques should be designed to:
  - assist in the initial establishment and subsequent growth of crop trees;
  - facilitate future fire protection;
  - provide access for future tending or harvesting;
  - minimise erosion and other detrimental environmental effects, either on or off-site. On-site effects include excessive soil compaction, puddling, mixing of topsoils and subsoils, and nutrient depletion often associated with inappropriate methods of site preparation. Off-site effects include excessive sediment runoff and damage to watercourse channels and habitats.



## E1.2.1 Native Forest Regeneration

### Basic Approach

**Table 9. Reforestation Technique Guide**

Type of Forest Required	Reforestation Technique	Where Most Appropriate
Even-aged Forests	Clearfell, burn and seeding by land or air	Used in both wet and dry forests, but particularly in even-aged wet forests which have a dense understorey shrub layer.
	Clearfell and use of lignotuber, coppice, advanced growth or seed from felled trees *	Generally in drier type forests. Additional seed may be necessary to supplement natural seed, lignotubers, coppice or advanced growth.
	Seed Tree*	Where retained trees (7-15 per ha) carry a suitable seed crop and an appropriate seed bed is available or can be prepared. This technique is appropriate in lower quality dry forest. Burning or scarification may be needed to create a seed bed.
	Shelterwood*	High altitudes, exposed sites (mainly <i>Eucalyptus delegatensis</i> , generally above 600 m).
	Plantations*	High capital cost approach where high forest productivity is required. Soils should be of reasonable depth and fertility (see <i>Forest Soils of Tasmania</i> <sup>8</sup> ).
Uneven-aged Forests	Advance Growth Retention*	Sites carrying an adequate stocking of vigorous advance regrowth up to potential sawlog size. Extra seeding is required if retained trees are not capable of restocking the site and natural seed sources are insufficient to fill the gaps.
	Potential Sawlog Retention	Sites with advance growth currently marketable as pulpwood but which has the potential to grow into higher value products.
	Single Tree or Group Selection *	Generally in drier forest types where markets or non wood values limit a higher level of utilisation. Disturbance from harvesting or cool burning is used to provide a seedbed.

\* Assessment of whether a post harvesting high intensity burn is required depends on site factors and assessment of wildfire hazard to the next crop. For further information consult the Native Forest Silviculture Technical Bulletins <sup>4, 20-28</sup>.

## ***Use Of Fire***

- See also Sections C1.2, page 27, and E3, page 91.
- Planning of the type of burn (where required) and the methods by which it will be achieved (fuel preparation, fire containment, weather conditions, when and how to burn), should be set down in a coupe burning plan.
- Where growing stock is retained (e.g. in partial harvesting systems such as advance growth retention), particular attention will be given to protecting it from fire damage.

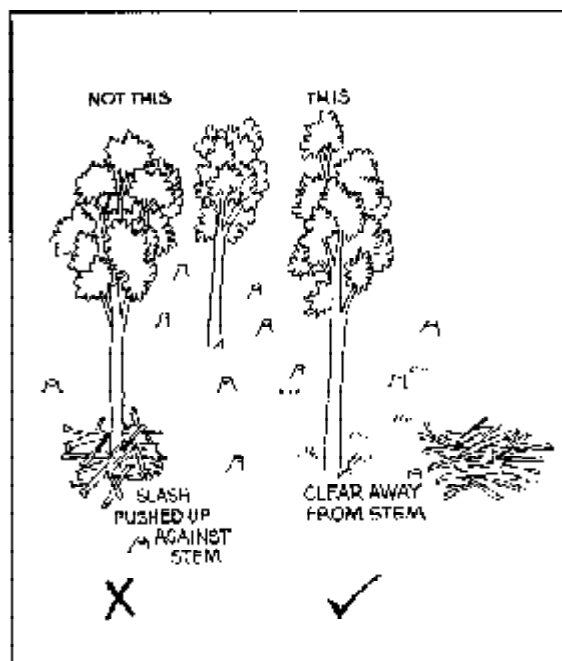

- The protection provided by leaving harvesting slash unburned should be weighed against increased fire risk. If the slash is left unburned appropriate fire protection measures should be implemented.
- Burning of native streamside reserve vegetation will be avoided, unless required as an essential part of hazard reduction.

## ***Mechanical Site Preparation***

- Where mechanical scarification is used to prepare seed beds:
  - care will be taken so that scarification does not result in unacceptable erosion, compaction, rutting or mixing of the soil;
  - drainage depressions, streamside or other reserves will be protected as per the standard provisions of this Code;
  - scarification will only be done in dry weather, and when the soil is not saturated (see Appendix 6).

## ***No Additional Site Preparation***

- Where sufficient established trees and an adequate seed bed exists following harvesting, further site preparation may be unnecessary, but fire protection requirements should be considered.

## E1.2.2 Plantation Development

### Basic Approach

- Plantation treatments have a high potential to affect soil and water values and site productivity. Thus the following plantation treatments need to be carefully considered, and appropriate prescriptions placed in the Forest Practices Plan:
  - windrow direction and heaping;
  - retention of slash to retain nutrients on site;
  - whether to burn and method of burning;
  - site cultivation method and direction of cultivation;

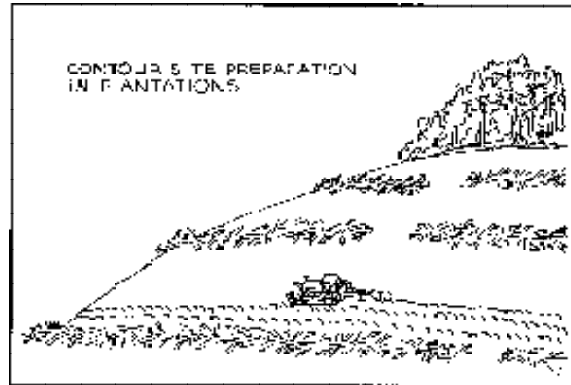

- slope limits on cultivation;
  - erosion control measures;
  - water quality protection measures;
  - drainage;
  - species and spacing;
  - weed control;
  - browsing control;
  - pest and disease control;
  - fertiliser application.
- Soil cultivation will be undertaken in a manner that minimises the risk of unacceptable soil erosion. The following table should be applied in a practical manner unless alternative measures are prescribed by a specialist and included in the Forest Practices Plan.

**Table 10. Windrowing, Mounding and Catch Drain Spacing for Different Slope and Soil Erodibility Classes.**

Majority Slope	Erodibility Class				
	Low	Moderate	Moderate - High	High	Very High
<3°	Any direction	Any direction	Any direction	Along contour	Along contour
3-8°	Contour preferred (CD 100 m)	Contour preferred (CD 80 m)	Contour preferred (CD 60 m)	Along contour	Spot cultivation*
9-11°	Contour preferred (CD 80 m)	Contour preferred (CD 60 m)	Along contour	Along contour	Spot cultivation
12-14°	Contour preferred (CD 60 m)	Along contour	Along contour	Spot cultivation	No cultivation
15-19°	Along contour	Along contour	Spot cultivation	No cultivation	No cultivation
20-26°	Spot cultivation	Spot cultivation	No cultivation	No cultivation	No cultivation
>26°	No cultivation	No cultivation	No cultivation	No cultivation	No cultivation
*Contour cultivation is generally acceptable on slopes <6°, but advice should be sought from a soil specialist.					
Windrowing and mounding can be undertaken in any direction. Catch drains (CD) are not required.					
	Contour windrowing and mounding is preferred. Mounding up and down the slope with catch drains (CD) at spacings shown in parentheses is acceptable.				
	Windrowing and mounding should only be along the contours (or use debris heaps).				
	No windrowing or mounding. Spot cultivation only. (Spot cultivation is not recommended on basalt talus or soils with landslide potential.)				
	No windrowing or mechanical cultivation.				

- Weed control carried out during site preparation will be planned to minimise the risk of soil erosion and the movement of chemicals off-site. Refer to Section E2.
- Advice will be sought from a soil specialist before plantations are established on sites with high or very high erodibility class soils. Appropriate prescriptions will be included in the Forest Practices Plan.
- Soil working operations should be carried out in dry weather conditions and when the soil is not wet (see Appendix 5) to minimise erosion, reduce puddling, mixing and compaction, and improve effectiveness of ripping. After cultivation soils should be friable and not smeared.
- Soil working operations will cease:
  - when soils are wet (see Appendix 5); or,
  - when turbid water is flowing for more than 10 m; or,
  - when machinery causes rutting to a depth of more than 200 mm below the original ground level over a 15 m section.

- As far as is practicable, windrows or heaps should be free of soil. Raker blades or excavators should be used to move and stack debris. Dozer blades should only be used to move stumps and other large material into windrows. Soil movement should be minimised.

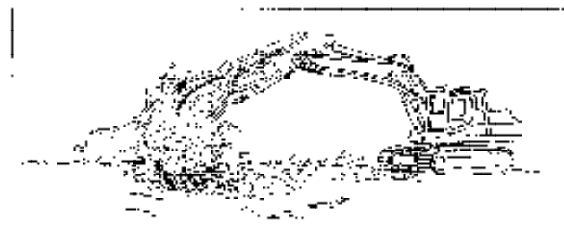

EXCAVATION WITH RIPPER ATTACHED USED TO EXTRACT STUMPS & MINIMISE SOIL ATTACHMENT TO ROOT BALLS.

- Where cultivation is not along contours, catch drains or angle mounds should be placed at falls of 1-3° at the same spacing as prescribed in Table 10 above.
- Water should be dispersed as much as possible. Water from culvert outlets should be directed onto stable ground, preferably vegetated or covered with slash. The area immediately below culvert outlets should generally not be cultivated. Allow for increased culvert sizes in areas to be cleared for plantations.

- Cultivation machinery may cross drainage depressions but drainage depressions should not be cultivated (by lifting cultivation equipment 2 m from the edge of the drainage depression), and will not be cultivated on high or very high erodibility class soils.

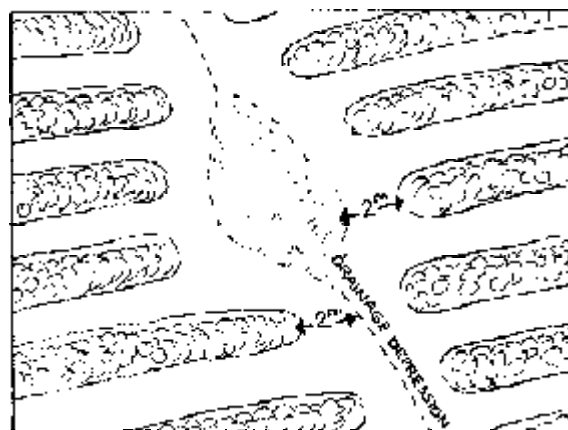

- Site preparation machinery will not be taken within 10 m of the border of any swamp or area with obvious surface seepage except at properly corded crossing points. Where swamp or surface seepage areas are ill-defined, the edges should be marked prior to the commencement of operations.
- Drainage of some plantation sections may be required. The erosion risk should be minimised by ensuring drains are constructed with stable profiles and controlled grades of preferably less than 2°. Entry of machinery into previously cleared streamside reserves to carry out this work will be at the discretion of the Forest Practices Officer and will be detailed in the Forest Practices Plan.
- Plantations will not be permitted on sites with vulnerable karst soils (see Glossary) unless authorised by the Chief Forest Practices Officer.
- Mapped caves that are near the surface, karst depressions and streamsinks will be avoided by site preparation machinery. The technical note *Some Operational Considerations in Sinkhole Management*<sup>19</sup> will be consulted where appropriate.

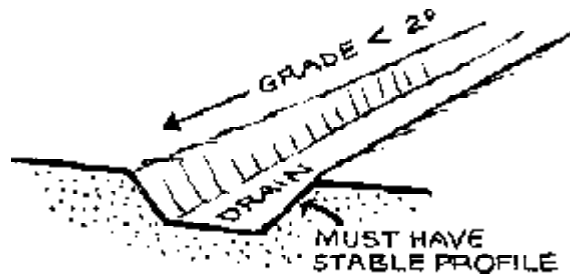

#### ***Establishment of plantations adjoining watercourses***

(This section covers establishment of: second and subsequent rotation plantations; new plantations within previously cleared streamside reserves; and plantations within 10 m of Class 4 watercourses).

- Existing native forest streamside reserves will be retained intact.
- All streamside reserves should be actively managed to provide long term conservation of riparian values.
- Establishment of native vegetation is encouraged as the best means to achieve protection of riparian values. (See references <sup>7, 27, 29</sup> for appropriate establishment techniques).
- Where the intent is to establish plantations, areas within Class 1, 2 and 3 streamside reserves should:
  - be considered for longer rotations and wider spacings, to mimic natural shading over watercourses;
  - be managed to encourage the re-establishment of native understorey species, especially in the last 10 m closest to the streambank;
  - be managed to keep introduced weed species to a minimum;
  - where practicable, be managed in accordance with the principles in *Riparian Land Management Technical Guidelines*<sup>29</sup>.

- Within Class 1, 2, and 3 streamside reserves plantation establishment will be permitted subject to the following:
  - patches of native vegetation will be retained;
  - burning and damage to understorey vegetation will be avoided where practicable;
  - no machinery will be permitted within 10 m of any watercourse except at points designated in a Forest Practices Plan;
  - debris will not be placed within 10 m of any watercourse and windrows will be positioned at least 10 m from streamside vegetation;
  - trees established within 10 m of a class 1, 2, or 3 watercourse will not be available for future harvest;
  - if slopes are over 11° or soils are of high or very high erodibility only spot cultivation will be permitted in order to establish plantations in the zone between 10 and 20 m from any watercourse;
  - cultivation will not be permitted in wet conditions;
  - special measures will be implemented where required for the protection of significant natural or cultural values e.g. to improve habitat for threatened fauna.

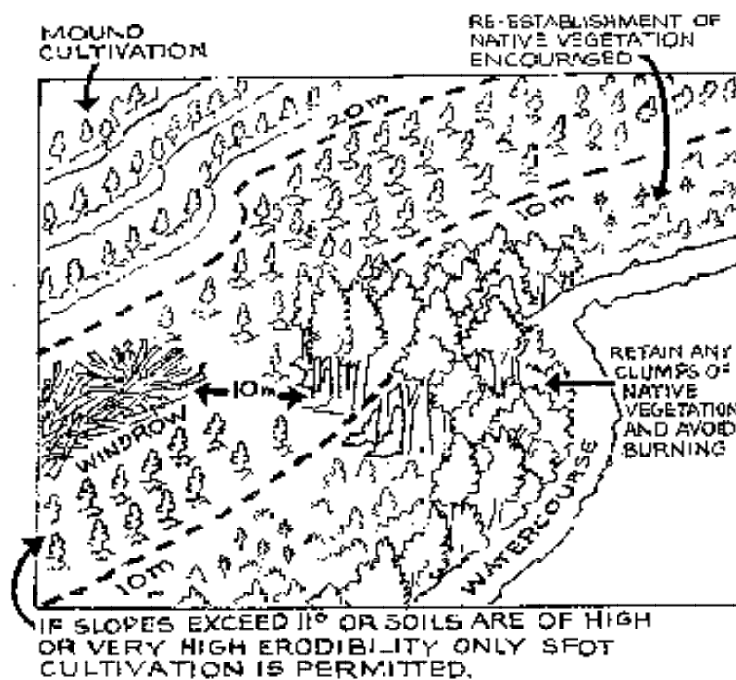

- Within 10 m of Class 4 watercourses plantation establishment will be permitted subject to the following:
  - burning will be avoided where practicable;
  - if slopes are over 11°, or soils are in the high or very high erodibility classes machinery will not enter within 10 m of the watercourse (except at designated crossing points as below), and cultivation will not be permitted;
  - in other situations:
    - spot cultivation and debris removal may be undertaken by excavators reaching to within 5 m of the watercourse, provided patches of native vegetation are not damaged;
    - on cleared land only (i.e. pasture, developed or undeveloped agricultural land), spot cultivation by excavators to establish plantations may occur to within 2 m of streambanks provided the excavator remains at least 5 m from the streambank;
  - machinery will not be permitted within 10 m of a Class 4 watercourse except to access crossing points designated in a Forest Practices Plan, or as per cleared land above;
  - cultivation will not be permitted in wet soil conditions or when water is running in surface channels (see Appendix 5);
  - debris will not be placed within 10 m of any watercourse and windrows will be positioned at least 10 m from streamside vegetation;
  - plantations will not be established within 2 m of any watercourse;
  - special measures will be implemented where required for the protection of significant natural or cultural values e.g. to improve habitat for threatened fauna.

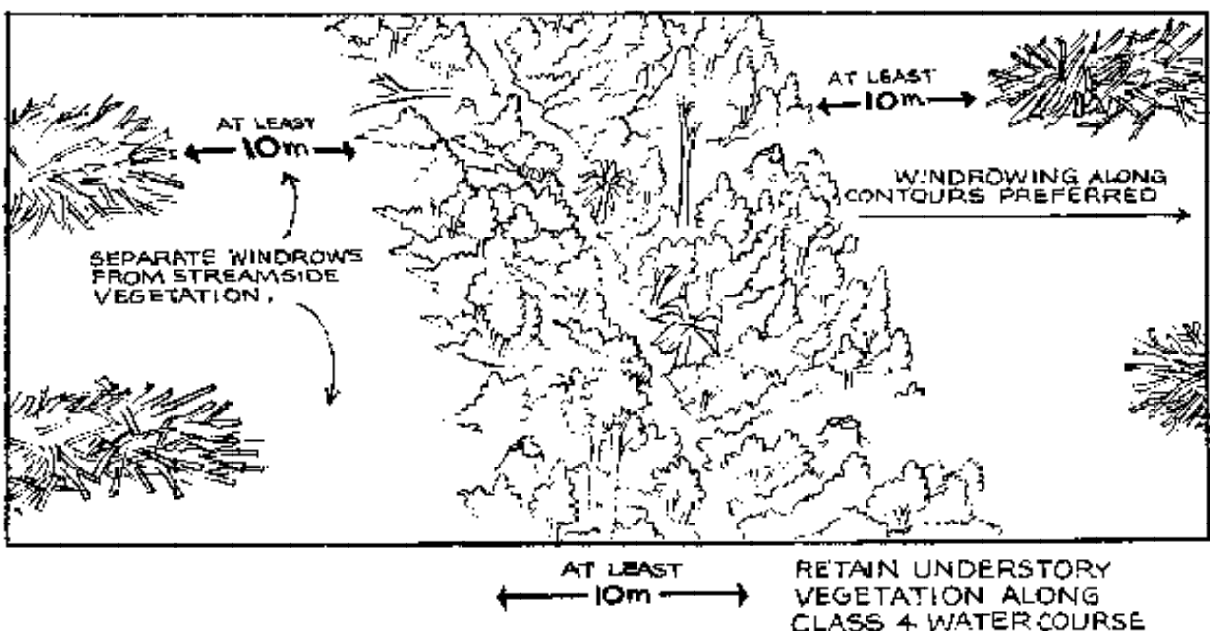

- Introduced weeds should be controlled where necessary.
- Application of approved herbicides and other chemicals is only permitted in accordance with Section E2.



- Construction of fire breaks and access tracks will not be permitted within the standard buffer widths for streamside reserves (as detailed in Table 8, page 56), or Class 4 machinery exclusion zones except to access crossing points designated in a Forest Practices Plan. Construction will be in accordance with Section E1.6, page 88. Existing fire breaks and access tracks should be relocated outside streamside reserves if erosion is likely to lead to watercourse siltation.

FIRE BREAK AND ACCESS TRACK CONSTRUCTION WITHIN PREVIOUSLY CLEARED STREAMSIDE RESERVES.

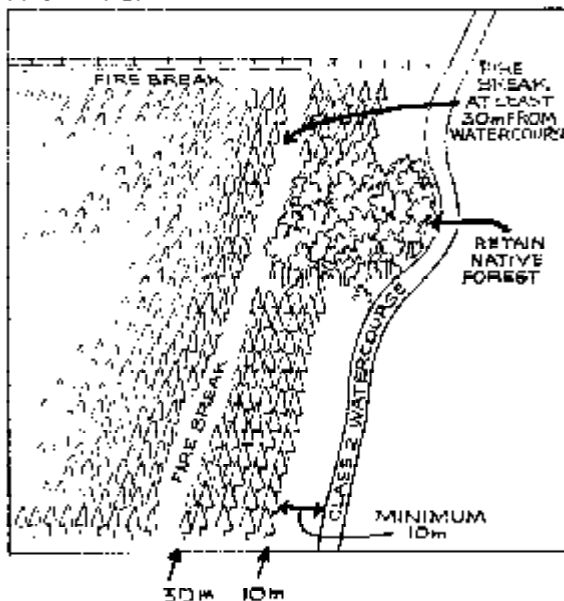

- The above provisions are interim and may be subject to new instructions on the basis of new knowledge and research.

### E1.3 Species Selection

#### General Principles

- Seed or seedlings should be of species suited to the soil and climate of the area to be reforested.
- For native forest regeneration seed should be sourced from the site to be reforested, where available, to ensure maintenance of the genetic resource.

#### Basic Approach

##### *Native forest regeneration*

- Sow or plant with a species composition approximating the natural canopy trees for the site. Allow for those species which will regenerate naturally.
- Seed to be sown should be collected from the stand to be felled or from the nearest similar ecological zone.
- Other species should not be used or added to the sowing mix except for control of forest diseases e.g. when a site with a high threat of damage from *Phytophthora cinnamomi* is being sown with eucalypts, a significant proportion of the seed should be from *Phytophthora*-tolerant species, particularly *Eucalyptus globulus* and *E. viminalis*.
- Further details can be found in *Eucalypt Seed and Sowing*<sup>28</sup>, or seek advice from a Forest Practices Officer.

## ***Plantations***

- Species and provenances should be selected which are suitable to the site and climate, and provide high sustainable growth rates.

### **E1.4 Stocking Standards**

#### **Basic Approach**

- The following stocking standards should be achieved in areas regenerated to native forest following harvesting (from *Regeneration Surveys and Stocking Standards*<sup>30</sup>, which also describes survey techniques and mapping rules):

#### – *Clearfelling*

Type of Stand Before Harvesting:  
(e.g. wet forests with dense understoreys).

Type of Stand After Harvesting:  
Less than 20 live trees per hectare over  
10 m tall remaining (may include  
potential sawlog retention ).



Stocking Standard Required:

The coupe should be mapped as stocked or have 65% of 16 m<sup>2</sup> plots stocked and no understocked patch shall exceed 1 ha in size nor should the total understocked area exceed 20% of the coupe.

#### – *Shelterwood (Uniform)*

Type of Stand Before Harvesting:  
(e.g. high altitude, exposed sites).

Type of Stand After Partial Harvesting:  
Evenly distributed trees retained at a rate  
of 12-14 m<sup>2</sup>/ha on high rainfall (> 1000  
mm/annum) sites or 9-12 m<sup>2</sup>/ha on dry  
sites (but see requirements for retention  
of habitat clumps, pages 62-63).

Type of Stand After Shelterwood Removal:  
Evenly distributed seedlings taller than  
1.5 m.

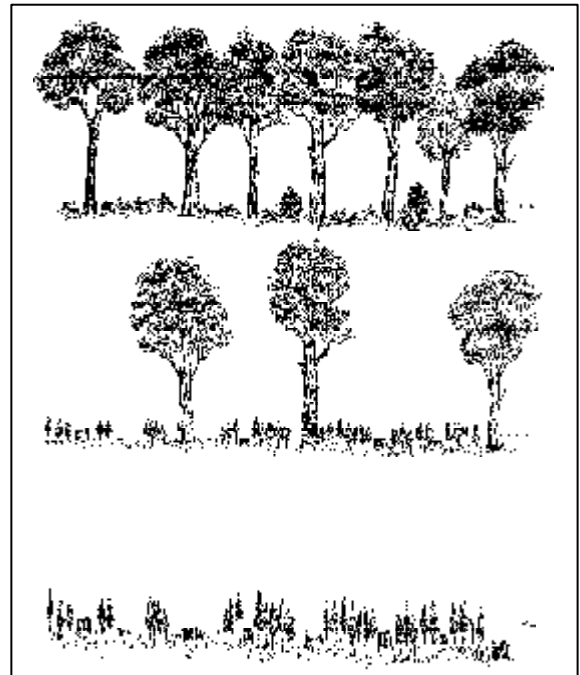

Stocking Standard Required:

As for Clearfelling, but on difficult to regenerate high altitude sites the survey should be done before the removal of the shelterwood and only seedlings taller than 1.5 m are counted.

– *Even-Aged Regrowth*

Type of Stand Before Harvesting:  
(e.g. wet forest regrowth with remnant oldgrowth trees).

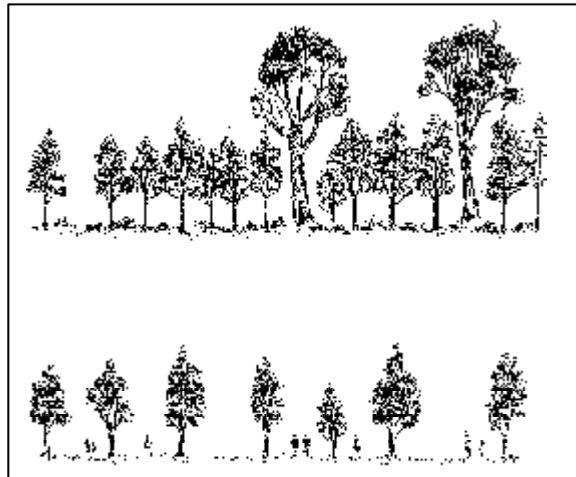

Type of Stand After Harvesting:  
Even-aged regrowth and any habitat trees remaining after overstorey removal and/or thinning of regrowth.

Stocking Standard Required:

At least 200 well distributed potentially commercial stems/ha over 10 m tall or at least 100 such stems per ha over 25 cm diameter.

– *Multi-Aged Stands*

Type of Stand Before Harvesting:  
(e.g. drier or high altitude forests).



Type of Stand After Harvesting:  
Multi-aged residual stand of trees potentially commercial (but see requirements for retention of habitat clumps, pages 62-63).

Stocking Standard Required:

Local stand basal area of at least 12m<sup>2</sup>/ha retained or an adequate stocking of regeneration (as per Clearfelling) where the retention is lower.

- The Forest Practices Plan for the area will specify the establishment and maintenance treatments that are most likely to achieve full restocking.
- Regeneration surveys should be carried out at 1 year of age following clearfelling, and at 2 years of age following partial harvesting. Periodic checks should subsequently be undertaken and rehabilitation measures implemented where necessary.
- Plantations should aim to achieve the optimal stocking determined for the management system used. The spacing will depend on the management system used.
- Where survival in plantations is less than 50%, re-establishment should be considered provided reasons for failure can be identified and corrective action is taken to ensure subsequent plantings do not fail.

## E1.5 Protection from Grazing and Browsing

### General Principles

- Grazing and browsing of seedlings, particularly in plantations, can severely reduce survival and growth.
- Protection of seedlings from serious damage by grazing and browsing should be provided.

### Basic Approach

- Regular monitoring of reforested areas starting at an early age and continuing until seedlings are over 1 m tall will be necessary to identify damage.

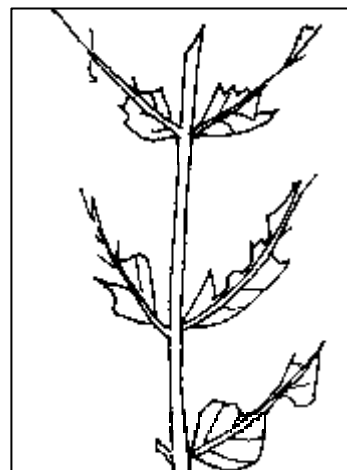

- If damage is likely to be severe control will be necessary. Methods for control of browsing include:
  - protection of planted seedlings by:
    - fencing;
    - individual tree protection;
    - selecting species and provenances less susceptible to browsing.
  - control of animal populations by:
    - shooting;
    - trapping;
    - use of poisons.

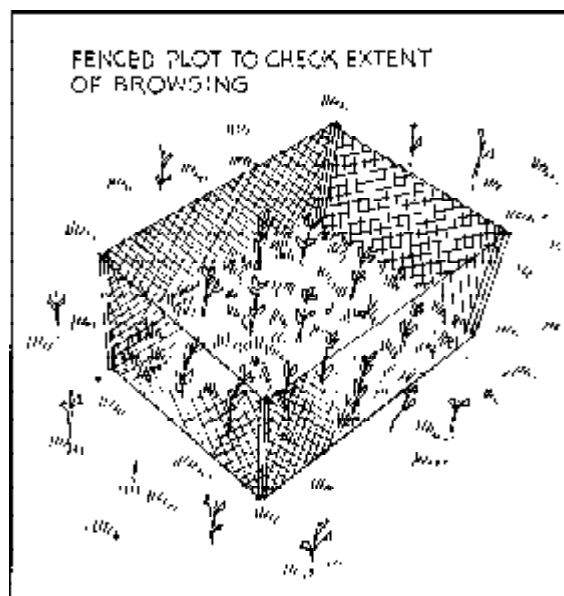

Where practicable, protection methods should be used rather than control methods.

- The procedures for monitoring and controlling browsing damage in native forests are outlined in *Monitoring and Protecting Eucalypt Regeneration*<sup>31</sup>.
- Crop protection licenses are required from DPIWE.
- 1080 may only be used by licensed officers of DPIWE or other authorised persons, and requires a written permit.

- Industry protocols such as the *Interim Code of Practice for Use of 1080 Poison for Native and Browsing Animal Control*<sup>32</sup> should be observed.
- Advice should be sought from DPIWE if 1080 is planned to be used in areas inhabited by susceptible non-target fauna (e.g. Tasmanian bettong). Consult fauna specialists and the *Field Guide for the Management of Browsing Animals in Tasmanian Forests and Farmland*<sup>33</sup>.

## E1.6 Fire Breaks and Access Tracks

### Basic Approach

- For access tracks to be used for carting, the provisions in Section B will apply.
- Permanent fire breaks and access tracks constructed as part of the fire management system will be carefully sited so that they can be drained properly and have minimal visual impact. Damage to mature myrtle trees should be minimised, as per the approach for road construction (see page 13).
- Access tracks will be drained as described on pages 8-9. Fire breaks will be gripped or barred using the standards set out in the Table 6, page 40.
- New access tracks and fire breaks will not be permitted within streamside reserves or Class 4 machinery exclusion zones except to access crossing points designated in a Forest Practices Plan. Existing fire breaks and access tracks should be relocated if significant watercourse siltation is likely.
- Disturbance will be minimised at watercourse crossings. Water bars will be constructed within the last 20 m before any crossing to divert water into sediment traps or vegetation before it enters the watercourse.

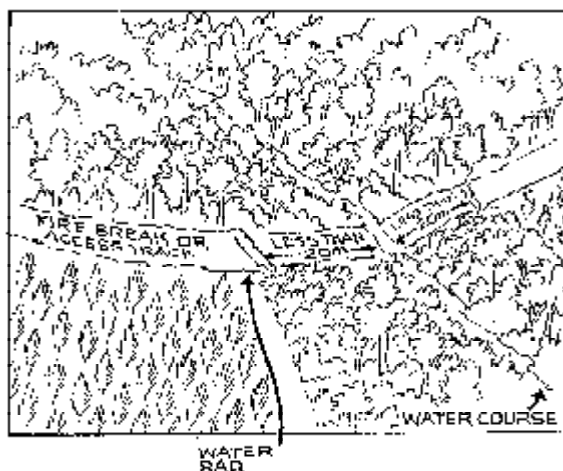

- Fire breaks should be maintained in a state that provides effective access and minimises vegetation build up. Methods that minimise soil disturbance are preferred.
- When maintaining fire breaks and access tracks, drainage structures will be retained or restored where necessary. Cultivation through watercourses will not be permitted.
- Non-permanent fire breaks constructed during the fighting of wildfires should be restored while machines are still on the job but in any case before the onset of the following wet season. Gripping should be done as per Table 6, page 40.
- Recreational vehicles should be barred from using firebreaks where erosion risk is high.

- Fire dams and water storage areas should be planned taking into account aquatic fauna values, and erosion risk, especially during floods. Dams should preferably be built in drainage depressions, and locations in or adjoining Class 1 or 2 watercourses should be avoided. Dam planning and construction approval may be required from DPIWE.

## E2. Use of Chemicals

### General Principles

- It is the forest owners responsibility to protect people, water resources, karst systems, and stock during the application of chemicals by ensuring appropriate guidelines and instructions are followed. The use of chemicals will not prejudice the achievement of the water quality objectives as determined under the State Policy on Water Quality Management.
- Any person proposing to use chemicals to control pests (including weeds) in watercourses or along streambanks should first investigate, and wherever practical, use non-chemical means of control unless it can be demonstrated that chemical control poses a lesser environmental risk than other practical options. Where chemicals are used, chemicals specifically designed for streamside application e.g. Roundup Bioactive should be preferred.

### Basic Approach

- Agricultural chemical use will comply with codes of practice <sup>34</sup> approved by the Agricultural, Silvicultural and Veterinary Chemical Council, under the *Agricultural and Veterinary Chemicals (Control of Use) Act 1995*.
- All chemicals used must be registered by the National Registration Authority for forestry use, or have an approved off-label permit for forestry use.
- It is the responsibility of the forest owner, forest manager and contractor to ensure that the appropriate chemicals are used and that they are correctly stored and applied and that any surplus is disposed of correctly.
- The handling, use and application of chemicals will only be conducted by suitably trained persons. Contractors conducting chemical application services on forest areas will be licensed as required by the *Agricultural and Veterinary Chemicals (Control of Use) Act 1995*.
- The person responsible for chemical application will ensure that chemicals do not enter waterbodies, unless the chemicals are specifically approved for direct application to waterbodies. Techniques such as wick-wiping and spot or shrouded strip application should be considered next to watercourses.
- Aerial spraying should not be conducted when there is a risk of drift into streamside reserves. Boundaries of reserves should be clearly visible or marked or delineated during operations by electronic means.

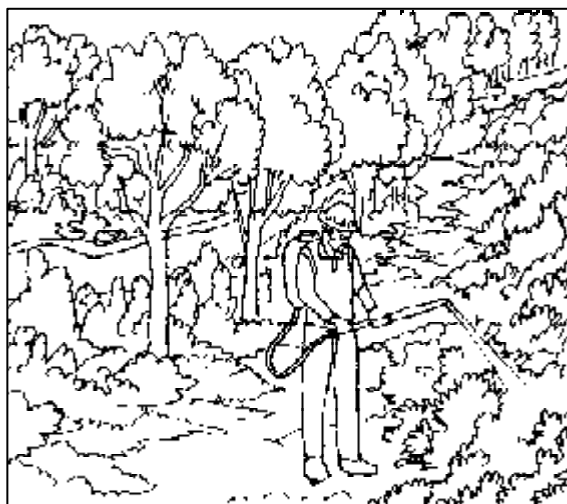

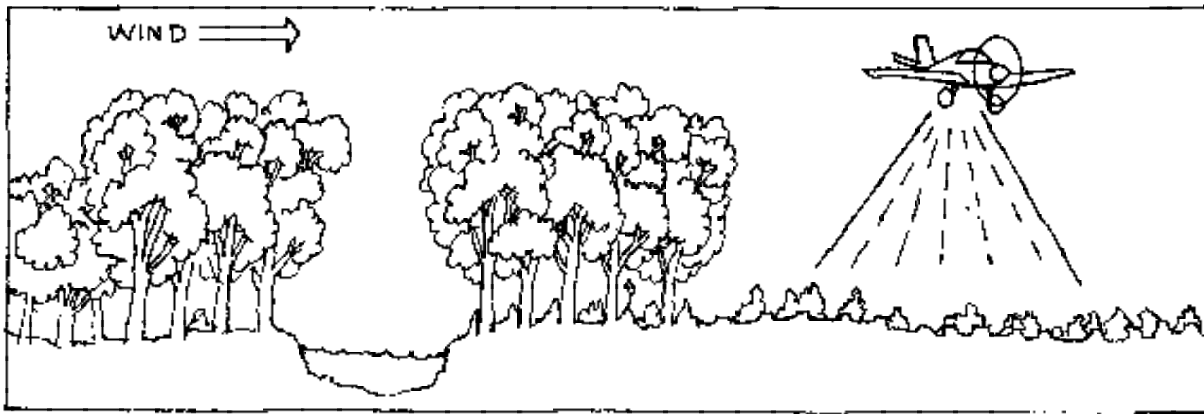

- Application of chemicals will not be permitted close to karst watercourses or known cave entrances.
- Liquid chemical containers will be returned to the suppliers where practical for refilling. Otherwise, they will be triple rinsed at a location that does not risk contamination to surface waters, and removed to an approved waste disposal site, or returned under the Drum Muster program. All rinsate or left over mixed spray solution will be applied to land in accordance with the manufacturer's instructions.
- All unwanted chemicals should be returned to the manufacturer, or otherwise disposed of as approved by DPIWE.
- Spillages of chemical concentrate will be attended to promptly to reduce the risk of contaminating waterways and soil, using documented emergency procedures. Large spillages that cause or threaten to cause serious or material environmental harm will be reported to DPIWE (phone 1800 005 171) as soon as practicable, and within 24 hrs.
- All equipment used for transport, storage and application of chemicals will be maintained in a leakproof condition. Application equipment will be appropriately calibrated.
- Chemicals will be stored, mixed and loaded in locations where any inadvertent leaks or spills will not enter table drains or waterbodies.
- Fertiliser application will be planned and carried out so as to minimise the chance of fertiliser being dropped or drifted onto any surface waters (streams, lakes, storages, swamps or wetlands).
- Occupiers of adjoining properties within 100 m of the area to be sprayed should be notified of any proposed spraying operations, and will be notified in the case of aerial spraying operations.

## E3. Fire Management

### Basic Approach

#### E3.1 Fire Management Plans

- See also Section F3 on Smoke, Noise and Dust.
- To protect the forest a fire management plan should be prepared by the landowner for all consolidated areas of commercial forest over 50 ha. Consult with a Forest Practices Officer.

- A fire management plan should be based on a simple map and a consideration of:

- landowners' and neighbours' assets requiring protection;
- proposed land use e.g. harvesting, clearing and grazing;
- direction of main fire threat;
- vegetation types and time since they were last burnt;
- fuel, distribution and flammability;
- fire detection;
- fire fighting methods and equipment;
- resources for control and suppression;
- access, firebreaks and fuel reduction measures to be applied;
- natural and cultural values (e.g. archaeological sites, karst sinkholes, dolomite knolls, rare fire susceptible flora, fauna requirements);
- the need to avoid burning of streamside reserves where practicable;
- the need to minimise environmental damage to watercourses during construction of fire breaks and fire dams.

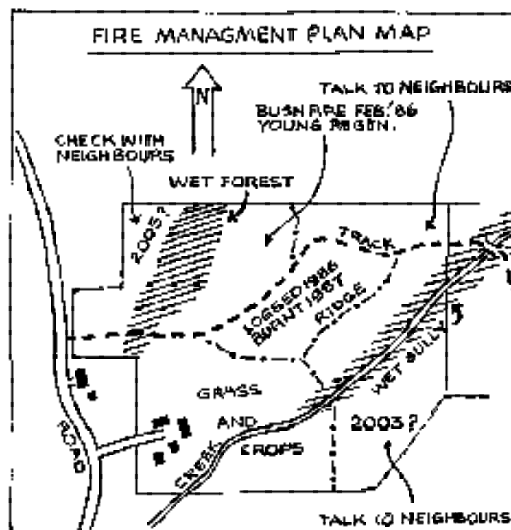

#### E3.2 Forest Practices Plans

- All Forest Practices Plans will state whether the area is covered by a fire management plan or not.
- The Forest Practices Plan for areas to be reforested but not covered by a fire management plan should specify the measures to be provided for the protection of the new forest from fire.



## E3.3 Burning

### *Fuel Reduction Burning*

- All fuel reduction burning in dry eucalypt forests should follow recognised industry practice such as outlined in *Using Low Intensity Fire in Land Management*<sup>35</sup>.

### *High Intensity Burning*

- Plans for high intensity burns should be prepared and accredited procedures complied with, such as those outlined in *High Intensity Burning*<sup>5</sup>.
- Persons responsible for the planning and conduct of high intensity burns (including windrow burns) adjoining areas with flammable fuels should hold appropriate competency accreditation.
- In forest where fire is not necessary for establishing regeneration, steep slopes should only be burnt if required for fire protection.

### *Burning in Karst Areas*

- Burning near cave entrances and sinkholes will be avoided.
- High intensity burning will be avoided where degradation of significant karst features is likely to result, such as sites with vulnerable karst soils (see Glossary) on slopes above 12°.

## E4. Pest, Disease and Weed Control

### General Principles

- Pests and diseases can pose economic and environmental threats.
- Lack of weed control can affect adjoining land and the viability of plantations. Noxious weeds can invade native forests.
- Consult the Selected Bibliography for references on major insect and disease symptoms and controls and for weed control.

### Basic Approach

#### E4.1 Insect Pests

- Monitoring of defoliating insects should be carried out and control of such insects may be required if eucalypt plantations are to be viable. If significant insect numbers are observed advice should be sought from a Forest Practices Officer.

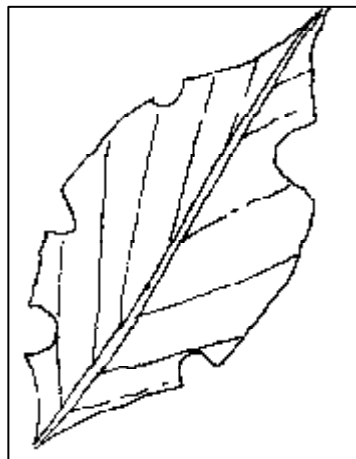

## E4.2 Diseases

- Where extensive, unexplained death or decline of trees occurs advice should be sought from a Forest Practices Officer.
- Healthy, disease free stock from nurseries should be used for planting. If a significant proportion of planting stock appears to be in an unhealthy or diseased condition, advice should be sought from a Forest Practices Officer.
- The root rot fungus *Phytophthora cinnamomi* is of concern in dry forests with a heathy, shrubby or swampy understorey, in heaths, sedgeland, moorlands, and some rainforest communities. Seek advice from Forest Practices Officers before commencing work in areas with these plant communities.
- Gravel produced from fragmented rock taken below the surface can be considered free from *Phytophthora cinnamomi*, provided the quarry is not contaminated with topsoil or runoff from surrounding areas.
- Myrtle wilt is a major disease of myrtle. Where road or track construction, harvesting or recreational facilities are planned in areas containing a component of mature myrtle (*Nothofagus cunninghamii*) consult a Forest Practices Officer.
- Needle cast can have serious effects on the viability of *Pinus radiata* plantations, particularly in the wetter part of the State. Consult a Forest Practices Officer for information.

## E4.3 Weeds

- A list of declared weeds which may cause problems in agricultural and forested areas is available from DPIWE.
- Before moving harvesting, roading and site preparation machinery from an area carrying declared weeds to an area free from weeds, machinery should be thoroughly washed on site, but well clear of any watercourse.
- Where applicable control measures will be specified in a Forest Practices Plan.

## E5. Thinning

### Basic Approach

- See *Thinning Regrowth Eucalypts*<sup>36</sup> for thinning regimes, timing of thinning etc.
- Harvesting aspects are covered in Section C.

## F. MANAGEMENT OF FUEL, OILS, RUBBISH AND EMISSIONS

- For management of chemicals see Section E2.

### General Principles

- A risk management approach should be taken for those activities which use, produce, convey or store significant quantities of materials which could cause serious or material environmental harm to soils or waters if released.
- Practices should be adopted that minimise the amount of waste products produced. Waste products should be recycled where appropriate.

### F1. Use of Fuel, Grease and Oils

#### Basic Approach

- Equipment will be maintained so that fuel leaks are minimised.
- Fuel, grease and oils will be stored in a location where any inadvertent leaks will not enter watercourses, swamps or other still waters, or karst systems either directly or indirectly.
- Any spills will be contained as soon as possible. Clean up procedures should be promptly implemented where necessary.
- Spills that cause or threaten to cause serious or material environmental harm (e.g. entry of fuel into a watercourse) will be reported to DPIWE (phone 1800 005 171) as soon as practicable, but within 24 hrs.

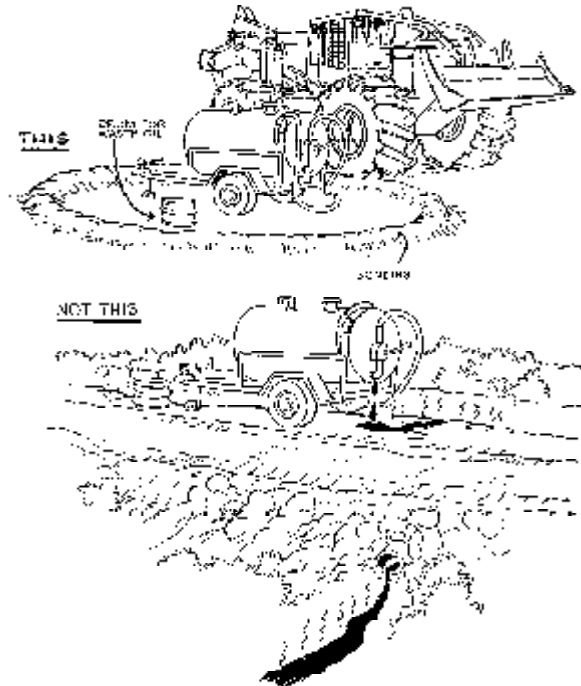

## F2. Disposal of Rubbish

### Basic Approach

- Rubbish such as oily wastes, fuel and oil drums, filters and oily rags will be regularly removed as they are generated or emptied to a collection depot suitable for receiving hazardous wastes.
- All other rubbish, e.g. wire ropes, plastic wrappings etc., will be removed regularly to a collection depot or transfer station, or recycled if appropriate.

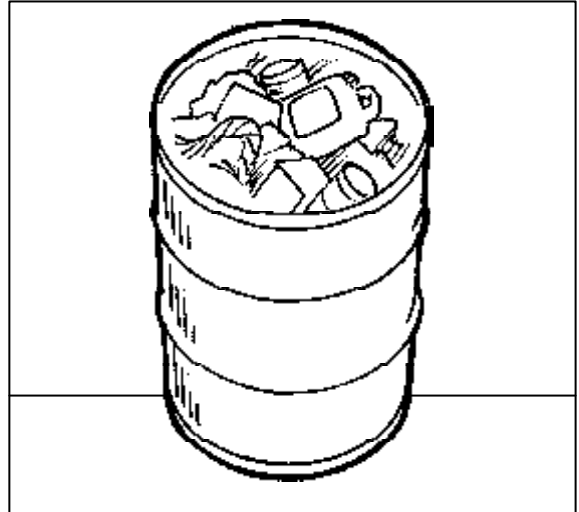

## F3. Smoke, Noise and Dust

### General Principle

- Care should be taken to ensure that emissions of smoke, dust or noise from forest operations do not cause serious or material environmental harm under the *Environmental Management and Pollution Control Act 1994*.

### Basic Approach

- Where forest operations are to take place near residences:
  - smoke from the burning of forest debris should be minimised by burning under appropriate conditions or alternatives to burning used where practicable;
  - occupants should be notified and consideration given to appropriate hours of machinery operation. Regard should be given to the *Environmental Protection (Noise) Regulations*.
- The use of explosive shots requires local government approval and a shotfirer's permit under the *Dangerous Goods (General) Regulations 1998*. Refer also to the *Quarry Code of Practice*<sup>2</sup>.
- Approaches which reduce the amount of dust emanating from road surfaces or quarries should be used where necessary to minimise adverse impacts. Refer also to the *Quarry Code of Practice*<sup>2</sup>.

## G. GLOSSARY

- Access track – A generally unsurfaced track, for short term or occasional use, designed for log truck and other vehicular access. Cartage is permitted in dry weather only. If intended for long term periodic access, permanent watercourse structures will be installed, as for Class 4 roads.
- Approved operator – A machinery operator who has passed an appropriate operator course accredited by the Forest Practices Board and the Tasmanian Forest Industry Training Board, and who maintains an acceptable standard of operation.
- Batter – Inclination or shape of a cutting beside a road or track.
- Borrow pit – A small area along a road construction line where earth/gravel may be taken for use in the construction of the road. Duration of use less than one year (see also quarry).
- Bridge – A structure that provides for vehicular access over a watercourse while generally causing minimal interference to natural watercourse flow; usually has abutments and a roading surface supported by beams.
- Cable harvesting – A hauling system employing winches, blocks and cables.
- Catchment – An area or basin of land bounded by natural geomorphological features from which water drains and flows to a river, watercourse, lake, wetland or estuary.
- Chemicals – Includes the range of insecticides, fungicides and herbicides which may be used in forest operations.
- Clearfelling – The felling of all or nearly all trees from a specific area in one operation. The term applies to patches with a diameter greater than four to six times average tree height.
- cm – centimetres
- Conservation – The wise use of natural resources, on a sustainable basis, to meet the needs of both present and future generations.
- Coppice – Growth of a new stem or stems from the stump or base of a tree to replace a previous stem that is damaged, killed or felled.
- Cording and matting – Cording and matting involves the use of suitable logs, bark or vegetation to spread the weight of the load and separate machine tyres or tracks from direct soil contact during harvesting operations, thus reducing ground pressure and rutting. With matting a complete cover over the soil is created using an excavator before machinery operates over the site.
- Coupe – An area of forest of variable size, shape and orientation, on which harvesting takes place. Usually to be harvested and regenerated over one or two years.
- Cross drain (Grip) – A ditch and earth bank constructed at approximately right angles to a track, preventing water from building up speed along the track and allowing redirection of running water into surrounding areas.
- Crossfall drainage – See outslope.

- Culvert – A conduit, typically of manufactured piping or logs, that provides for passage of water.
- Damaged soil – Damaged soil is soil that has either:
  - had the A horizon (topsoil) removed; or,
  - had the A horizon mixed with the B horizon (subsoil usually containing clay); or, with bark, litter or wood debris; or,
  - suffered severe compaction; or,
  - been contaminated with chemicals, fuel, grease or oils.

Damaged soil has a significant effect on the establishment and growth of plants.

- Domestic water supply – Used for the household but not including farming livestock or irrigation.
- DPIWE – Department of Primary Industries, Water and Environment.
- Drainage depression – A drainage depression is a depression which only carries water during or shortly after rainfall (see also watercourse and Table 8, page 56).
- Environmental harm – Serious environmental harm and material environmental harm have the same meaning as defined in the *Environmental Management and Pollution Control Act 1994*.
- Erodibility – See soil erodibility.
- Even-aged forest – A forest composed of trees of mainly the same age resulting from a single disturbance.
- Feeder snig track – A snig track with less equipment traffic than for major snig tracks (see major snig track).
- Fire break – A strip of land, preferably at least 5m wide, where vegetation has been removed to reduce the risk of fire starting or spreading.
- Ford – A road crossing of a watercourse involving minimal alteration to the natural watercourse bed, eg. installation of flexmat at the invert.
- Forest Practices Officer – A person appointed under Sections 38 and 39 of the *Forest Practices Act, 1985*.
- Forest Practices Plan – A plan for forest operations as specified in Section 18 of the *Forest Practices Act 1985*.
- Fuel reduction burn (Low intensity prescribed burn) – A fire of low intensity carried out under closely controlled conditions to reduce the quantity of accumulated dead fuel from the forest floor without damaging standing timber.
- Geoconservation – The conservation of geodiversity for intrinsic, natural process, (including ecological processes), and heritage values.
- Geodiversity – The range or diversity of geological materials, geomorphological features (landforms) and soil features, assemblages, systems and processes.
- Gravel pit – See quarry.

- Grip – See cross drain.
- ha – hectares
- Habitat tree – A habitat tree is a mature living tree selected to be retained in a coupe because it has features of special value for wildlife (e.g., hollows). Habitat trees should be selected on the basis of size and the presence of hollows or the potential to develop hollows over time.
- Harvesting machine – Wheeled or tracked equipment used for harvesting.
- Harvesting section – A sub-division within a harvesting coupe. Usually the area from which logs will be snigged to a single landing.
- Hazardous trees – Trees which may be classified as hazardous include:
  - trees with shallow root systems located in unstable ground conditions;
  - trees with root systems exposed to excessive drainage causing erosion or soft soil conditions;
  - trees regularly exposed to machinery vibration;
  - trees with visible root damage or excessive defect(s) which would appear to affect their structural soundness e.g. rotted;
  - dead trees;
  - all trees with “widow makers” within one tree length of the work site;
  - all trees with an obvious lean towards the work site;
  - trees exposed to the prevailing wind. Exposed means where an adjacent tree, upwind of the prevailing wind direction, has been removed or the tree closest to the work site is 10% higher than surrounding trees and is located up-wind of the work site (landing, quarry, or road).
- Headwall – Solid surround provided at either end of a culvert to minimise erosion, may be of rock, cement, sandbag or wooden construction.
- High intensity burn (Slash burn) – a planned burn conducted under weather and fuel conditions which promote a fire of sufficient intensity to consume fuels for the purpose of forest regeneration or plantation establishment.
- hrs – hours
- Karst – A landscape that results from the high degree of solubility in natural waters of the bedrock. Underground drainage, sinkholes and limestone caves are the best known components of karst.
- Karst depression – A depression in a karst landscape caused by dissolution of soluble bedrock by water that has drained underground; variable in shape and size and may be formed in rock or sediments overlying karstic rocks; includes:
  - various types of sinkholes, sinkhole complexes and slots or shafts that can be defined by a closed depression contour;
  - linear depressions with no closed contour such as apparently “dry” valleys or channels that occur in areas where subsurface soil water seeps underground, or where an underground watercourse may resume a surface course when the capacity of the underground conduits is exceeded under wet conditions.
- Karst soils – Residual or transported soils in a karst area. Accumulation of materials deposited above a soluble bedrock parent material (see also vulnerable karst soils).

- km – kilometres
- kPa –kilopascals
- Landing – An area to which logs are pulled and where logs are loaded onto trucks, i.e. the working area for cross-cutting, sorting and loading of logs. This does not include areas used solely for stockpiling.
- Lignotuber – A swelling on a tree at or just below the ground which is made up of a mass of dormant buds and food reserves.
- m – metres
- mm – millimetres
- m<sup>2</sup> – square metres
- m<sup>3</sup> – cubic metres
- Major snig track – Snig track used for five or more passes of ground-based snigging equipment on wet soils, or for ten or more passes on dry/rocky soils.
- Majority slope – Refers to the steepness of 90% of a coupe area e.g. for a majority slope of 20°, 90% or more of a coupe area should be on slopes of 20° or less, 10% of the coupe area may be steeper than 20°.
- Matting – See cording.
- Outslope – Fall of a track over its width so that the surface is sloped to shed surface water to the downhill side.
- Partial harvesting – Harvesting systems which include the retention of some trees e.g. advance growth, seed tree, shelterwood, group and single tree selection.
- Permit – A licence or authority issued for specified purposes.
- Planning scheme – A planning scheme has the same meaning as defined in the *Land Use Planning and Approvals Act 1993*, but includes for the purpose of this Code the term special planning order as defined under that Act.
- Plantation – A forest stand established by the planting of seedlings or cuttings of trees selected for their wood producing properties and managed intensively for the purpose of future timber harvesting.
- Private Land Reserve Program – A program established under the Tasmanian Regional Forest Agreement designed to develop that part of the Comprehensive Adequate and Representative reserve system applicable to private land.
- Private Timber Reserve – An area of land so designated in the *Forest Practices Act 1985*.
- Property – In the case of private land means the area defined by a unique Property Index (PID).
- Provenance – A geographic area in which a species has developed particular characteristics recognisably different from the characteristics of the species from other areas.



- p.s.i. – pounds per square inch
- Quarry – An area of land where earth/gravel is extracted for use on roads. Duration of use exceeds one year (see also borrow pit).
- Reforest – To re-establish a tree crop on forest land.
- Regeneration – The renewal of a tree crop arising from planting or from seed or the young plants on a site.
- Regeneration unit – An area of forest planned to be regenerated as a single unit.
- Reserve/Reservation – An area of land formally or informally set aside for specified purposes. Formal reserves include State Reserves, Forest Reserves etc. Informal reserves include wildlife habitat strips, and other areas where harvesting activities are specifically excluded by management zoning.
- Rip rap – Stone material used to protect exposed soils to minimise erosion.
- Shelterwood – The removal of a forest stand in two cuts. Around 30-50% of the stand is retained for 10 years or so to protect establishing new forest from extreme weather conditions.
- Shovel harvesting – Harvesting systems using excavators or tracked loading machines with log grabs to lift and move logs while the harvesting machine is stationary.
- Sinkhole (Doline) – A closed depression draining underground in karst, of simple but variable form e.g. cylindrical, conical bowl – or dish-shaped. From few to many hundreds of metres in dimensions.
- Slash – Material left on the ground after harvesting operations including tree heads, shrubs and other non-merchantable woody material.
- Snigging – The pulling or carrying or carrying of logs from the felling point to a landing by wheeled skidders, forwarders, bulldozers, or tracked loaders.
- Snig track – A track along which logs are pulled from the felling point to a nearby landing (see major and feeder snig track).
- Soil erodibility – The inherent susceptibility of a soil to erosion (detachment and movement of soil particles or aggregates) by processes such as rainfall, runoff, throughflow, wind and frost.
- Soil erodibility class – This Code divides soils into five erodibility classes – low, moderate, moderate-high, high, and very high. Refer to Appendix 6.
- Spoon drain – A shallow semi-circular open drain, normally traversable by vehicles, designed to carry water to the side of a road, access track or fire break.
- Spot cultivation – The cultivation of up to 50% of a site using an implement attached to the arm of an excavator or similar machine.
- Static ground pressure – Static weight of a machine divided by width and length of the machine's tracks.

- Steep country – An area with slopes of 20° or above.
- Streamside reserve – All land within a minimum distance specified in the Code from the banks of a Class 1, 2 or 3 watercourse, lake, artificial storage or tidal water (see also Table 8, page 56).
- Swamp – A generally or permanently waterlogged area which may or may not have associated tree growth; or a tract of low, ill-drained ground with patches of open water in which reeds, rushes and sedges occur. Swamp sediments are dominated by still water deposits, commonly with a high organic content.
- Temporary watercourse crossing – A crossing of a watercourse by an access track designed for removal following short term use, having a designed opening to take typical peak annual flows (i.e. approximately bank full), e.g. a log culvert, and a cover of slash for a running surface.
- Threatened species – A species listed on current schedules of the *Threatened Species Protection Act 1995*.
- Town water supply catchments – All catchments arising from town water supply intakes as listed in Appendix 2.
- Turbid water – Water bearing significant quantities of soil particles i.e. muddy water.
- Understorey – That part of forest vegetation growing below the forest canopy.
- Uneven-aged forest – A forest composed of trees of at least three ages intermingled on the same area.
- Unstable areas – Sites susceptible to one of the forms of mass soil movement or accelerated soil erosion as a result of the interaction of such factors as steepness, soil properties, parent and surface geology and position in the land form profile.
- Vulnerable karst soils – Soils in the following categories:
  - thin residual soils derived from in situ limestone;
  - thin or high or very high erodibility soils derived from other parent materials;
  - Medium Sensitivity Zones in Category A or B karst areas and specified locations in Category C and D Karst areas\*.

Karst soils of lower vulnerability, not included in the definition of “vulnerable karst soils” above are:

  - thick soils on limestone or dolomite;
  - Low Sensitivity Zones in Category A karst areas\*.

\* As described in *An Atlas of Tasmanian Karst*<sup>3</sup>.
- Water bar – A diversion ditch or hump in a road or track to redirect surface water runoff and reduce erosion.
- Watercourse – A natural depression carrying perennial or intermittent flows of surface water for part or all of the year in most years, consisting of a defined channel, with banks and a bed along which water may flow (see also watercourse and Table 8, page 56).
- Wildlife habitat clump – An area containing habitat trees set aside in a harvesting coupe to aid in the maintenance of fauna habitat diversity.
- Windrow – An elongated heap of forest debris pushed up for burning.

## H. REFERENCES

1. *Estimation of Peak Flows for Small to Medium Sized Rural Catchments*. Pilgrim, D. H. (1993), in *Australian Rainfall and Runoff, A Guide to Flood Estimation, Volume 1*. The Institute of Engineers, Australia.
2. *Quarry Code of Practice*. Department of Primary Industries, Water & Environment; Department of Infrastructure, Energy and Resources (1999), Environment Protection, Planning and Analytical Services Division, Hobart.
3. *An Atlas of Tasmanian Karst, Volumes 1 & 2*. Kiernan K., (1995), Research Report No. 10, Tasmanian Forest Research Council Inc.
4. *Silvicultural Use and Effects Of Fire*. Forestry Commission Tasmania (1993), Native Forest Silviculture Technical Bulletin No. 11, Forestry Commission Tasmania.
5. *High Intensity Burning*. Forestry Tasmania (1999), Forestry Tasmania.
6. *Fire Prevention at Timber Harvesting Operations: Procedures for Severe Weather Closures and Specifications for Fire Weather Monitoring and Fire Fighting Equipment*. Forest Industry Fire Prevention Committee (reviewed annually), Forestry Tasmania.
7. *A Guide to Riparian Vegetation and its Management*. Munks, S. (Ed.) (1996), Department of Primary Industry & Fisheries, Tasmania.
8. *Forest Soils of Tasmania. A Handbook for Identification and Management*. Grant, J. C., Laffan, M.D., Hill, R. B., and Neilsen, W. A. (1995), Forestry Tasmania.
9. *Forest Soil Conservation Manual*. Brown G. and Laffan M. (1993), Forestry Commission, Tasmania.
10. *Basalt and Dolerite Slope Deposit Guidelines*. Forest Practices Board (1999 unpublished), Forest Practices Board, Hobart.
11. *Forest Botany Manuals*. Forest Practices Board (various), Forest Practices Board, Hobart.
12. *Threatened Fauna Manual for Production Forests in Tasmania* (revised ed.). Forest Practices Board (1998), Forest Practices Board, Hobart.
13. *Threatened Fauna Adviser*. Forest Practices Board (1999), Forest Practices Board, Hobart.
14. *Fauna Technical Note Series*. Forest Practices Board (various), Forest Practices Board, Hobart.
15. *Fauna Conservation in Production Forests in Tasmania*. Taylor, R. J., (1991), Forest Practices Unit, Forestry Commission Tasmania, Hobart.
16. *A Manual for Forest Landscape Management*. Forestry Commission Tasmania (undated), Forestry Commission Tasmania, Hobart.
17. *Forest Practices Forest Archaeology Manual*. Forestry Commission Tasmania (undated), Forestry Commission Tasmania, Hobart.
18. *Geomorphology Manual*. Forestry Commission Tasmania (1990), Forestry Commission Tasmania, Hobart.
19. *Some Operational Considerations in Sinkhole Management*. Forest Practices Board (1999 unpublished), Forest Practices Board, Hobart.
20. *High Altitude E. delegatensis Forests*, Forestry Commission Tasmania (1990), Native Forest Silviculture Technical Bulletin No. 2, Forestry Commission Tasmania.

21. *Lowland Dry Eucalypt Forests*, Forestry Commission Tasmania (1991), Native Forest Silviculture Technical Bulletin No. 3, Forestry Commission Tasmania.
22. *High Altitude E. dalrympleana and E. pauciflora Forests*, Forestry Commission Tasmania (1990), Native Forest Silviculture Technical Bulletin No. 4, Forestry Commission Tasmania.
23. *Silvicultural Systems*, Forestry Commission Tasmania (1994), Native Forest Silviculture Technical Bulletin No. 5, Forestry Commission Tasmania.
24. *Remedial treatments*, Forestry Commission Tasmania (1992), Native Forest Silviculture Technical Bulletin No. 7, Forestry Commission Tasmania.
25. *Lowland Wet Eucalypt Forests*, Forestry Tasmania (1998), Native Forest Silviculture Technical Bulletin No. 8, Forestry Tasmania.
26. *Rainforest Silviculture*, Forestry Tasmania (1998), Native Forest Silviculture Technical Bulletin No. 9, Forestry Tasmania.
27. *Blackwood*, Forestry Commission Tasmania (1991), Native Forest Silviculture Technical Bulletin No. 10, Forestry Commission Tasmania.
28. *Eucalypt Seed and Sowing*. Forestry Commission Tasmania (1991), Native Forest Silviculture Technical Bulletin No. 1, Forestry Commission Tasmania.
29. *Riparian Land Management Technical Guidelines*. Lovett, S. & Price, P. (eds.) (1999), Land and Water Resources Research and Development Corporation, Canberra.
30. *Regeneration Surveys and Stocking Standards*. Forestry Commission Tasmania (1991), Native Forest Silviculture Technical Bulletin No. 6, Forestry Commission Tasmania.
31. *Monitoring and Protecting Eucalypt Regeneration*. Forestry Tasmania (1999), Native Forest Silviculture Technical Bulletin No. 12, Forestry Tasmania.
32. *Interim Code of Practice for Use of 1080 Poison for Native Browsing Animal Control*. Department of Primary Industries Water and Environment (1999), Department of Primary Industries Water and Environment, Tas.
33. *Field Guide for the Management of Browsing Mammals in Tasmanian Forests and Farmland*. Dredge, P. (undated), The Wild Animal Management Group of Tasmania, Tas.
34. *Code of Practice for Aerial Spraying*. and *Code of Practice for Ground Spraying*. Department of Primary Industries Water and Environment (1999), Department of Primary Industries Water and Environment, Tas.
35. *Using Low Intensity Fire in Land Management*. Forestry Tasmania (2000), Forestry Tasmania.
36. *Thinning Regrowth Eucalypts*. Forestry Tasmania (1998), Native Forest Silviculture Technical Bulletin No. 13, Forestry Tasmania.
37. *A method for assessing the erodibility of Tasmanian forest soils*. Laffan, M, Grant J and R Hill (1996), Australian Journal of Soil and Water Conservation 9, (4), 16 - 22.

## I. SELECTED BIBLIOGRAPHY

### GENERAL

<i>Forest Practices Act 1985</i>	Printing Authority Of Tasmania	
State Policy on Water Quality Management	Printing Authority Of Tasmania	1997
State Coastal Policy	Printing Authority Of Tasmania	1996
<i>Environmental Management and Pollution Control Act 1994</i>	Printing Authority Of Tasmania	
Tasmanian Forest Safety Code	Workplace Standards Tasmania	draft
Forest Practices Planning Manual	Forest Practices Board	draft

### BUILDING ACCESS TO THE FOREST

Unsealed Roads Manual	Aust. Road Res. Board Ltd.	1993
Rehabilitation of Disturbed Sites in Tasmania with Native Species	DPIWE	
Rehabilitation Guidelines for Forest Construction	Forestry Commission Tasmania	

### HARVESTING OF TIMBER

Tasmanian Cable Logging Code	Tas. Timber Ind. Training Council	1999
------------------------------	-----------------------------------	------

### CONSERVATION OF NATURAL AND CULTURAL VALUES

<i>Aboriginal Relics Act 1975</i>	Printing Authority Of Tasmania	
<i>Historic Cultural Heritage Act 1995</i>	Printing Authority Of Tasmania	
<i>National Parks and Wildlife Act 1970</i>	Printing Authority Of Tasmania	
<i>Threatened Species Protection Act 1995</i>	Printing Authority Of Tasmania	
Forest Practices Fauna Manual	Forestry Commission Tasmania	1990

### ESTABLISHING AND MAINTAINING FORESTS

#### — PLANTATIONS

Site selection for hardwood and softwood plantations in Tasmania (Soils Technical Report No. 3)	Forestry Tasmania	1997
The Farm Forestry Toolbox	Private Forests Tasmania	1999

#### — USE OF CHEMICALS

Pesticide Application Manual	Forestry Commission Tasmania	1994
<i>Agricultural and Veterinary Chemicals (Control of Use) Act 1995</i>	Printing Authority Of Tasmania	

#### — FIRE MANAGEMENT

Fire Management Manual	Forestry Commission Tasmania	1992
------------------------	------------------------------	------

#### — PESTS, DISEASES, WEED CONTROL

<i>Phytophthora cinnamomi</i> Root Rot	Leaflet No. 6, Forestry Tasmania	
Identifying Pests in Tasmania's Forests	Info. Sheets 1-7, Forestry Tasmania	
Weed Control in Tasmanian Forests	Info. Sheets 1-6, Forestry Tasmania	

# APPENDIX 1

## PROTOCOL FOR FORESTRY FIELD MARKING COLOURS

The table below shows the standard marking colours recommended for field use in the forest industry in Tasmania.

- A single clear, distinctive colour is allocated to each primary use in the table below. Primary uses and colours are:
  - Harvest/Site preparation boundary ..... light blue
  - Roadlines ..... red
  - Property boundary ..... pink
  - Research/Silviculture/Inventory Plots ..... yellow
  - Survey lines/General purpose ..... orange
  - Assessment ..... whiteUnder **no** circumstances should light blue tape be used for purposes other than for harvesting or site preparation boundaries.
- High visibility colour versions of flagging tapes should be used where available. Biodegradable tape should only be used for situations where high visibility and longevity is not critical. Striped tape is prone to fading and therefore it is recommended only for relatively short term uses.
- In low light or heavy undergrowth situations the distance between individual pieces of tape placed in the field should be reduced to minimise the risk of boundaries being accidentally crossed. Night time operations should be scheduled away from boundaries where possible.
- In some situations it may be appropriate to use two tape colours together e.g. for a harvesting boundary which is also a wildlife habitat strip the light blue tape may be supplemented with yellow and white striped tape.
- Forest Practices Plans should refer to the tape colours being used on a coupe. Ideally the colour of tape/paint used in the field should also be reflected in the colours used on the Forest Practices Plan map.

## PROTOCOL FOR FORESTRY FIELD MARKING COLOURS

USE	COLOUR	COMMENTS
<b>Harvesting boundary</b>	<b>Light blue</b> tape	Including coupe, streamside reserves and wildlife habitat strips/clumps. Indicates a boundary that cannot be crossed by fallers, (except individual trees as below*), or harvesting machinery.
<b>Site preparation boundary</b>	<b>Light blue</b> tape	Indicates a boundary that cannot be crossed by plantation site preparation machinery.
<b>Road location</b>	<b>Red</b> tape or paint	Indicates the location of the proposed road centreline.
<b>Property boundary</b>	<b>Pink</b> tape or paint	
<b>Silviculture, Research, Inventory</b>	<b>Yellow</b> tape	Generally long term use. Inventory – permanent plots only.
<b>Survey</b>	<b>Orange</b> tape	Profiles for cable harvesting, general purpose survey, outrow tracks in plantations etc.
<b>Sales</b>	<b>Orange</b> paint (preferred)	Log marking, tagged logs to be retrieved in harvesting operation, landing location. *Individual trees marked for harvesting from a native forest streamside reserve by a Forest Practices Officer.
<b>Assessment</b>	<b>White</b> tape	Generally short term use. Assessment strip take-off points, assessment traverses, temporary plots.
<b>Sub-coupe harvesting boundary</b>	<b>Blue and white</b> striped tape	Indicates a section boundary in a coupe e.g. between cable and conventional harvesting sections.
<b>Machinery exclusion zone</b>	<b>Blue and white</b> striped tape	Generally marking will be 10m from the watercourse, indicating the point beyond which only excavator type feller bunchers are permitted.
<b>Natural and Cultural Values</b>	<b>Yellow and white</b> striped tape	Used by Forest Practices Board specialists to flag areas identified during survey (e.g. location of aboriginal artefacts).
<b>Works</b>	<b>Red and white</b> striped tape (preferred)	Windrow locations, culvert locations etc.
<b>Snig track watercourse crossings</b>	<b>Red and white</b> striped tape	Indicates a crossing point on a Class 3 or 4 watercourse.
<b>Hazard</b>	<b>Yellow</b> tape (75mm) with black lettering "CAUTION"	Used to mark dangerous trees for falling etc.
	<b>Yellow and black</b> striped tape (75mm)	Used by Workplace Standards Tasmania inspectors when a prohibition notice is issued stopping access to a section of forest.

## APPENDIX 2

### TOWN WATER SUPPLY AND FRESHWATER AQUACULTURE FACILITY INTAKES

Map Sheet 1:100000	Stream/River (Waterbody)	Scheme/ Facility	Map Co-ordinates of Intake		Code No.
			E	N	
Circ. Head 7916	Deep Creek	Smithton/ Stanley	344500	5476400	001
Inglis 8015	Cam River	Somerset/ Wynyard	402100	5454200	008
	Pet River	Burnie	402300	5434500	009
	Guide River	Burnie	396500	5434500	010
	Dowlings Ck.	Yolla	390800	5445300	011
	Waratah River	Waratah	377700	5410500	012
Forth 8115	Leven River	Penguin	422900	5442000	013
	Forth River	Sheffield/ Railton	438700	5420600	117
	West Gawler R.	Ulverstone	427200	5433000	014
	Forth River	Devonport	436300	5438200	015
	Forth River	Devonport	437500	5430900	016
Tamar 8215	Curries River	George Town/ Bell Bay	496000	5450500	023
Pipers 8315	South Esk River	West Tamar Reg.	507100	5411300	024
	North Esk River	North Esk Reg.	530000	5406300	025
	St. Patricks River	Launceston	525000	5417100	026
	Distillery Ck.	Launceston	518400	5413250	118
	McGowans Ck.	Lilydale	520200	5433100	027
	Rocky Creek	Lilydale	518900	5431100	028
	Brid River	Bridport	533000	5459400	029
	Brid River	Scottsdale	540000	5440500	030
	St. Patricks R.	Mountain Stream Fishery	531600	5427600	*
Forester 8415	Great Forester R.	Scottsdale	542900	5430900	031
	Ringarooma R.	Branxholm	561800	5447000	032
	Ringarooma R.	Ringarooma/ Legerwood	560800	5434900	033
	Cascade R.	Derby/Herrick	568800	5441800	034
	Frome R.	Pioneer	578000	5450900	035
	South Esk R.	Mathinna	574200	5409100	037
	Briseis Race	Branxholm	563300	5441300	038
	Vineys Creek	Ringarooma	563400	5429100	039
	Great Forester R.	Springfield Fisheries	542000	5431800	*

\* Freshwater aquaculture facility intake



Map Sheet 1:100000	Stream/River (Waterbody)	Scheme/ Facility	Map Co-ordinates of Intake		Code No.
			E	N	
Swan Is. 8516	Ringarooma R.	Gladstone	585500	5465800	041
Georges Bay 8515	George River	St. Helens	601800	5428100	042
	Scamander R.	Scamander	599500	5411200	043
Break O'Day 8514	Margisons Ck.	St. Marys (emerg.)	600100	5398000	044
	Fingal Rivulet	Fingal	584300	5386500	045
	Apsley R.	Bicheno	604600	5361800	046
	Newmans Ck. Trib. Break	St. Marys	599400	5398400	047
	O'Day R.	Cornwall	595600	5398700	048
St. Pauls 8414	St. Pauls R.	Avoca	559700	5373800	049
	South Esk R.	Conara	543300	5372900	050
	South Esk R.	Fingal	580200	5389400	051
	South Esk R.	Avoca	560200	5374700	052
Meander 8214	Liffey R.	Carrick	500100	5401700	053
	Meander R.	Exton	477400	5404500	054
	Meander R.	Westbury/ Hagley	482600	5405800	055
	Meander R.	Deloraine	470500	5402000	056
	Liffey R.	Bracknell	495300	5388500	058
South Esk 8314	Macquarie R.	Longford	510300	5395400	060
	South Esk R.	Perth	515000	5396500	061
	South Esk R.	Evandale	516000	5398200	062
	South Esk R.	Epping Forest	531200	5378800	063
	Elizabeth R.	Campbell Town	541300	5357600	064
	South Esk R.	Longford	510200	5396000	065
	Macquarie R.	Cressy	507700	5385300	066
	Brumbys Ck.	Sevrup	508300	5382800	*
Mersey 8114	Mole Ck.	Mole Ck.	447600	5395000	057
Sophia 8014	Stitt R.	Rosebery	379400	5373000	067
	Mountain Ck.	Rosebery	380000	5373700	068
	Pieman R.	Rosebery	377100	5374200	069
Pieman 7914	Parting Ck.	Zeehan	361300	5363800	070
	Savage River	Savage River	350200	5406400	071

\* Freshwater aquaculture facility intake

Map Sheet 1:100000	Stream/River (Waterbody)	Scheme/ Facility	Map Co-ordinates of Intake		Code No.
			E	N	
Franklin 8013	Roaring Meg Ck.	Queenstown	380800	5338500	072
	Reservoir Ck.	Queenstown	381500	5339500	073
	Conglomerate Ck.	Queenstown	382000	5340700	074
Nive 8113	Derwent R.	Saltas	458000	5306150	*
Shannon 8213	Florentine R.	Saltas	460000	5301200	*
Lake Sorell 8313	Clyde R.	Bothwell	500200	5308000	075
	Blackman R.	Oatlands	517900	5323800	076
	Blackman R.	Tunbridge	534200	5334500	077
	Macquarie R.	Ross	540400	5346300	078
Little Swanport 8413	McClaines Ck.	Triabunna	572600	5295100	079
	Brady's Ck.	Triabunna	573300	5294900	080
	McClaines Ck.	Triabunna	574300	5293800	081
Freycinet 8513	Swan R.	Swansea	588800	5344500	082
	Trib. Saltwater Ck.	Coles Bay	607800	5336800	083
Nugent 8412	Prosser R.	Orford	569400	5287700	084
Derwent 8312	Illa Brook	New Norfolk	504200	5287500	085
	Derwent R.	Hobart	501700	5264800	086
	Risdon Brook Res.	Hobart	527200	5261000	087
	Flagstaff Gully Res.	Hobart	530400	5256900	088
	Ridgeway Res.	Hobart	523800	5248400	091
	Lower Res.	Hobart	524200	5249500	089
	Stevensons Ck.	Mountain R.	510000	5245900	092
	Rocky Ck.	Huonville	504800	5246900	093
	Iles Ck.	Colebrook	525500	5289900	094
	Long Ck.	Hobart	519500	5246400	122
	Fork Ck.	Hobart	520000	5247000	123
	Browns River	Hobart	520700	5247600	124
Tyenna 8212	Lake Fenton	Hobart/Nat.Park/(Lady Barron Ck.) Westerway	473600	5273200	095
	Derwent R.	Gretna	494500	5274100	096
	Dora Ck.	Judbury	493600	5241900	097
	Derwent R.	Ouse	477500	5293100	098
	Jones R.	Ellendale	475400	5280300	100

\* Freshwater aquaculture facility intake

Map Sheet 1:100000	Stream/River (Waterbody)	Scheme/ Facility	Map Co-ordinates of Intake		Code No.
			E	N	
	Clyde R.	Hamilton	486200	5288500	090
	Tyenna R.	Nortas	477000	5274200	*
	Tyenna R.	Nortas	484750	5274900	*
	Plenty R.	IFS	497400	5266400	*
	Russell R.	Hill	483200	5245000	*
	Little Denison R.	Snowy Range Aquaculture	483700	5241000	*
Wedge 8112	Lake Pedder	Strathgordon	422100	5264700	101
Huon 8211	Shields Ck.	Glen Huon	496300	5234100	102
	Clarks Rvt.	Franklin	499200	5232000	103
	Trib. Clarks Rvt.	Franklin	499000	5231900	104
	Prices Ck.	Franklin	498500	5230000	105
	Fleurtys Rvt.	Franklin	497800	5227500	106
	Castle Forbes Rvt.	Castle Forbes Bay	495900	5225800	107
	Scotts Rvt.	Geeveston	492800	5226000	108
	Kermandie R.	Geeveston	490000	5218500	109
	Esperance R.	Dover	497000	5201900	110
D'Entrecasteaux 8311	Huon River	Huonville	501000	5237500	111
	Agnes Rvt.	Cygnet	507700	5223000	112
	Parsons Bay Ck.	Tasman Pen.	561000	5223000	121
	Nicholls Rvt.	Cygnet	512500	5264300	113
	North West Bay River	Margate/Snug (emergency)	519800	5238300	114
	Clearwater Ck.	Cygnet (emergency)	512800	5225000	116
Storm Bay 8411	Un-named Ck.	Port Arthur	567200	5223000	115

\* Freshwater aquaculture facility intake

## APPENDIX 3

### A GUIDE FOR OPERATIONS ON VERY HIGH ERODIBILITY CLASS SOILS

#### General Principles

- To achieve acceptable standards all phases of harvesting operations should be:
  - planned in particular detail;
  - marked in the field where applicable;
  - covered by careful equipment and operator selection;
  - closely supervised.
- Disturbance should be kept away from drainage depressions and lower slopes as the potential for erosion is greatest in these areas.
- Soil disturbance and exposure should be kept to a minimum.
- A vegetative ground cover and canopy closure should be aimed for as soon as possible after harvesting.
- Some other soils with high erodibility should also be managed under these guidelines.

#### Basic Approach

##### *Roading*

- Ridge top roading will be maximised.
- Clearing width will be minimised, but will include the removal of hazardous trees which may fall onto the road surface.
- Road grades should be minimised.
- Class 3 and 4 roads and access tracks will be one truck width with passing bays as required, and have due regard to trafficability (avoid crabbing) for log trucks. Such tracks will be outsloped (<3°) to shed water.
- Batter slopes on granite soils will be steeper than 45°; other soils may require other protective works.
- No borrow pits will be created.
- Surface interference in creeks will be minimised. Tea-tree or other root systems will be maintained in place as much as possible, particularly at culvert inlets and outlets.
- Major water courses will not be altered.

- Culvert spacings will be as per Table A below.

**Table A. Maximum Spacing between Table Drain Outlets or Culverts for Forest Roads on Soils of Very High Erodibility**

Road Grade	Spacing
1 - 5%	70 m
6 - 10%	40 m
11 - 20%	30 m

- For road grades over 10%, table drain protection should be considered e.g. gravelling into table drains.
- Where necessary energy dissipating measures such as rock linings will be installed at the ends of culverts.
- Table drains, where used, will be of minimum depth and lined with base course.

### ***Harvesting***

- Conventional harvesting will be restricted to slopes below 19°, and should be kept below 14°.
- All landings will be located on ridges or spurs. Only swing boom excavators or similar equipment should be used for loading.
- Uphill snigging will be maximised.
- Side cutting of snig tracks will not be permitted.
- Snigging patterns will be planned so that the number of snig tracks is minimised.
- Primary snig tracks will be located on spurs or ridges or other areas where water flow is least likely.
- A system of secondary snig tracks running across the slope on the contour will be used wherever possible.
- No snig track will be created if it cannot be adequately drained. This includes slopes up which machines cannot reverse.
- Class 4 watercourses and drainage depressions will only be crossed at approved locations.
- These crossing locations will be carefully chosen as positions least likely to promote erosion or water degradation. Areas with rock and abundant downstream vegetation are preferred.
- Class 4 watercourses and drainage depression crossings will be corded.

### ***Restoration***

- Cross banks 0.6 - 0.8 m high should be constructed across the slope with an outlet allowing water to trickle onto undisturbed areas.

- Cross drains will be spaced as per Table B below.

**Table B. Maximum Spacing between Cross Drains on Snig Tracks**

Gradient of snig track	Spacing of cross drains
0 - 3°	40 m
4 - 14°	30 m
15 - 19°	20 m
over 19°	no snigging

- Restoration of snig tracks will be progressive so that no more than 2 to 3 snig tracks are open at any one time. Restoration of a snig track will be done on the same day the track is no longer required for snigging.
- Operations will not be left without restoration when wet weather is likely. Temporary gripping will be done:
  - before an operation ceases due to wet weather;
  - before shutting down for the night, weekend or holiday if rainfall is predicted;
  - before an operation is moved from the site for any reason.
- Heaps of bark may be placed to impede water flow as a temporary restoration measure.

#### ***Wet Weather Limitations***

- Ground based snigging will cease when water is running in table drains or in wheel ruts of roads within the harvesting area as a direct result of rain and may be resumed when this water ceases to run.

#### ***Streamside Reserves***

- Additional watercourse protection will be provided as per Table C below.

**Table C. Watercourse Protection on Sites with Very High Erodibility Soils**

Watercourse Type	Streamside Reserve/ Machinery Exclusion Zone
Class 3	30 m
Class 4	No machinery within 15 m
Drainage depressions	No machinery within 5 m

- Drainage depressions will be marked on Forest Practices Plans and crossed only at designated points. The number of such crossings will be minimised.

#### ***Reforestation***

- Burning of slash should be minimised.

- Where natural regeneration from seed trees, heads of fallen trees or other sources is likely to be sparse, additional sowing or planting, particularly on or next to snig tracks should be considered and carried out as soon as possible after harvesting.

### ***Fire Control***

- Any burning to be undertaken will be by cool head disposal burns only. Such burns should not run freely from head to head. Scorch to remaining trees should be minimised.
- Fire breaks and access tracks will not be constructed adjacent to watercourses and within streamside reserves. Their use elsewhere will also be minimised. Snig track restoration standards prescribed in Table B above will apply.
- Burning of understorey vegetation adjoining watercourses and drainage depressions should be avoided.

## **APPENDIX 4**

### **A GUIDE FOR OPERATIONS ON SOILS WITH HIGH OR VERY HIGH ERODIBILITY BY WIND.**

#### **General Principles**

- To achieve acceptable standards all phases of harvesting operations should be:
  - planned in particular detail;
  - marked in the field where applicable;
  - covered by careful equipment and operator selection;
  - closely supervised.
- Soil disturbance and exposure should be kept to a minimum, particularly on crests and upper slopes of dunes where the potential for erosion is greatest. Exposure of the loose sands underlying the generally thin and weakly developed organic topsoils will significantly increase the risk of severe erosion.
- A vegetative cover and canopy closure should be established as soon as possible after harvesting.

#### **Basic Approach**

##### ***Roading***

- Access roads should aim to prevent or at least minimise side-cuts into the dunes, and especially across dune crests.
- Access tracks should generally be located in swales between dunes.
- Side-cuts will be protected with a layer of slash placed over the surface of exposed sand.
- Public access should be managed to reduce the potential for damage by off-road vehicles.

##### ***Harvesting***

- Snig tracks will be formed on the surface of the dunes and not cut through them.
- Where harvesting is scheduled in very highly erodible recent sands a belt of trees at least 3 rows wide (but much wider where severe sand encroachment is already occurring), will be retained on the seaward side to act as a shelter belt and provide protection to areas further inland.
- In blocks with poorer stands of trees, selective harvesting rather than clearfelling is preferable as this will provide more effective protection to the soil from wind.

##### ***Reforestation***

- Regeneration or planting will be carried out as quickly as possible after harvesting.
- All harvesting slash will be retained on the ground to protect the soils from the effects of the wind.



- Burning of slash and total mechanical cultivation prior to planting will be avoided. Instead, planting should be made through the slash cover with minimal site disturbance on very high erodibility soils, and only strip or spot cultivation on high erodibility soils.
- Only spot or strip weed controls should be used, and planting of cover crops will help stabilise soils.

## APPENDIX 5

### A FIELD TEST FOR ASSESSING SOIL WATER STATUS

#### *Sample Collection*

- Samples from the soil surface to a depth of 20 cm (0 – 20 cm) should be taken and tested individually from at least 6 sites considered to be representative of the coupe. Samples may be collected using a hand auger, spade or trowel. Sufficient soil should be collected to fill the palm of the hand.

#### *Sample Testing*

- The tests involve observing the behaviour of the soils when squeezed in the hand.

---

<b>Soil Water Status</b>	<b>Behaviour of soils tested</b>
<b><i>Dry</i></b>	Soils will not form a ball when squeezed. Sands or sandy loams will flow through the fingers, or fragments will powder.
<b><i>Moist</i></b>	Soils form a ball when squeezed. Sands and sandy loams form a weak ball which breaks easily.
<b><i>Wet</i></b>	The soil ball leaves a wet outline when squeezed, or is wetter (saturated). Loams and clays are sticky.

---

## APPENDIX 6

### AN OUTLINE OF SOIL ERODIBILITY CLASSES IN RELATION TO SOIL PROPERTIES.

#### *Definition of Soil Erodibility*

Erodibility is the inherent susceptibility of a soil to the detachment and transportation of soil particles or aggregates by erosive agents such as rainfall, runoff, throughflow, wind or frost. In the Forest Practices Code, erodibility is concerned principally with susceptibility to erosion by rainfall and runoff, although erosion by wind is important on sites such as sand dunes.

#### *Soil Erodibility Classes*

In the Forest Practices Code, measures to prevent erosion are applied to soils according to their classification into one of five soil erodibility classes (low, moderate, moderate-high, high, very high). A semi-quantitative methodology has been developed<sup>37</sup> for assessing the erodibility class of Tasmanian forest soils based on both field and laboratory determinations of soil properties. They include the proportion of water-stable soil aggregates using wet-sieving and/or dispersion tests, soil strength, stone content, thickness of soil layers, and permeability and drainage classes. A brief outline of the five erodibility classes in terms of soil field characteristics is appended.

#### *Low Erodibility*

Soils in this class are characterised by free drainage, moderate or high permeability, clay loam or clay textures with high aggregate stability, or are extremely stony with sandy or loamy textures. They are formed on a wide variety of substrates.

#### *Moderate Erodibility*

Soils are freely drained and friable with loamy textures and moderate aggregate stability, or have impeded drainage (imperfectly drained) with clayey textures and high aggregate stability. They are formed on a wide range of substrates.

#### *Moderate-High Erodibility*

Soils are imperfectly drained grey and brown mottled clays or poorly drained grey clays or highly organic with moderate aggregate stability; or they are moderately well drained and have bleached sandy layers with low aggregate stability overlying moderately permeable clays; or they have pale loams with moderate aggregate stability overlying slowly permeable clays. They occur on a range of substrates.

#### *High Erodibility*

##### *a) By water (rainfall and runoff)*

Soils mostly have texture-contrast profiles characterised by dark-coloured topsoils with moderate or high aggregate stability overlying bleached sandy or very fine sandy/silty layers (<50 cm thick) with low aggregate stability which in turn overlie slowly permeable clays or hardpans. If the organic-rich topsoils are breached or removed the underlying sandy/silty layers are highly susceptible to detachment and transport by rainfall and runoff. They are formed mainly under dry forests on sandy substrates including sandstones, conglomerate, and granite. However, also included are loamy soils on dolomite under wet forest, clayey soils with dispersible subsoils on mudstone under dry forest, and sandy or silty soils on Quaternary glacial deposits.

*b) By wind*

Soils highly erodible by wind include deep, loose sandy soils with dark-coloured topsoils overlying yellowish brown subsoils or bleached sands over humus and iron pans. They occur on relatively stable coastal dune systems and in dry inland areas as dunes, sand sheets and lunettes on floodplains, margins of lagoons, river terraces and at the base of hills.

***Very High Erodibility***

*a) By water (rainfall and runoff)*

Soils are mainly formed under dry forest on Quaternary alluvial deposits derived from granite. They occur mainly along drainage depressions and adjacent to small watercourses in north-east Tasmania. Soil profiles are characterised by weakly developed topsoils with low aggregate stability overlying unconsolidated deep coarse sands also of low aggregate stability. The total thickness of surface and subsurface layers with low aggregate stability is 50 cm or more.

Also included but less commonly occurring, are texture-contrast soils under dry forest on granite hill slopes. Profiles are characterised by weakly developed topsoils overlying thick (>50 cm), bleached coarse sandy layers which in turn overlie slowly permeable clays. Both these soil types are highly susceptible to gully erosion if surface layers are unduly disturbed.

*b) By wind*

These soils occur on recent foredunes and adjacent relatively unstable sand dunes in coastal areas where soil profiles are characterised by deep, loose, uncoloured sands with only very weak, if any, development of topsoils.

***Erodibility in Relation to Soil Colour and Texture***

Soil colour and texture can be useful characteristics to help classify soil erodibility. Loamy or clayey soils with dark-coloured topsoils overlying uniformly coloured yellow, brown or red subsoils generally have low or moderate erodibility. In contrast, loamy or clayey soils with distinct grey mottling or dominantly grey colours in subsoils usually have moderate to high erodibility. Soils with bleached, loose, sandy layers are generally highly or very highly erodible depending on their thickness and the degree of development of topsoils.

## APPENDIX 7

### SLOPE ANGLES IN DEGREES AND PER CENT

#### DEGREES TO PER CENT

DEGREES (°)	PER CENT (%)	DEGREES (°)	PER CENT (%)
1.0	1.7	23.0	42.4
2.0	3.5	24.0	44.5
3.0	5.2	25.0	46.6
4.0	7.0	26.0	48.8
5.0	8.7	27.0	51.0
6.0	10.5	28.0	53.2
7.0	12.3	29.0	55.4
8.0	14.1	30.0	57.1
9.0	15.8	31.0	60.1
10.0	17.6	32.0	62.5
11.0	19.4	33.0	64.9
12.0	21.3	34.0	67.5
13.0	23.1	35.0	70.0
14.0	24.9	36.0	72.7
15.0	26.8	37.0	75.4
16.0	28.7	38.0	78.1
17.0	30.6	39.0	81.0
18.0	32.5	40.0	83.9
19.0	34.4	41.0	86.9
20.0	36.4	42.0	90.0
21.0	38.4	43.0	93.3
22.0	40.4	44.0	96.6
		45.0	100.0