

TASMANIA

FOREST SAFETY CODE

# Forest Safety Code (Tasmania) 2007

Information in this Code may be freely copied for personal or industry use or published for educational or training purposes provided that extracts are fully acknowledged.

The preferred citation is  
Forest Safety Code (Tasmania) 2007

Produced by the Safety Standards Committee  
Tasmanian Forest Industries Training Board Inc.  
PO Box 2146 Launceston TAS 7250  
Ph: 03 6331 6077 Fx: 03 6331 1679 Email [foresttb@bigpond.com](mailto:foresttb@bigpond.com)  
Shop 4, Cornwall Square Transit Centre, Cimitero St. Launceston, TAS

## TABLE OF CONTENTS

|   |           |
|---|-----------|
| Preface .....   | 8         |
| Scope .....   | 9         |
| Purpose .....   | 10        |
| What is a Code of Practice? .....   | 11        |
| <b>1 LANGUAGE.....</b>  | <b>12</b> |
| <b>2 LEGAL FRAMEWORK AND GENERAL DUTIES .....</b>                                 | <b>13</b> |
| 2.1 Duties of Employers.....  | 13        |
| 2.2 Duties of Designers, Manufacturers, Importers, Suppliers and Installers ..... | 13        |
| 2.3 Duties of Employees.....  | 13        |
| 2.4 Hazard Identification and Risk Management .....                               | 13        |
| <b>3 GENERAL PRINCIPLES OF SAFETY.....</b>  | <b>14</b> |
| 3.1 Safety Planning .....   | 14        |
| 3.2 Roles and Responsibilities .....  | 14        |
| 3.3 Supervision.....  | 15        |
| 3.4 Working Alone.....  | 15        |
| 3.5 Working at Night .....  | 15        |
| 3.6 Road Access Restrictions .....  | 15        |
| 3.7 Employee Induction.....   | 15        |
| 3.8 Training.....   | 16        |
| 3.8.1 General.....  | 16        |
| 3.8.2 Supervision of Trainees .....   | 16        |
| 3.8.3 Training Objectives .....   | 16        |
| 3.8.4 Training Programs.....  | 16        |
| 3.8.5 Changed Operations.....   | 17        |
| 3.9 Operator Competency Standards.....  | 17        |
| 3.10 Personal Protective Equipment and Clothing (PPE&C).....                      | 17        |
| 3.10.1 Head Protection.....   | 19        |
| 3.10.2 Safety Footwear.....   | 19        |
| 3.10.3 Hearing Protection.....  | 19        |
| 3.10.4 Leg Protection .....   | 19        |
| 3.10.5 Hand Protection .....  | 19        |
| 3.10.6 Eye Protection .....   | 19        |
| 3.10.7 High Visibility Safety Garments .....                                      | 19        |
| 3.10.8 Respiratory Protection .....   | 20        |
| 3.11 Forest Operations Signage .....  | 25        |
| 3.11.1 Tree Felling Operations .....  | 25        |
| 3.11.2 Forest Operations Not Involving Tree Felling .....                         | 25        |
| 3.11.3 Visitor Control.....   | 25        |
| 3.12 On-Site Amenities .....  | 25        |
| 3.13 First Aid.....   | 25        |
| 3.13.1 General.....   | 25        |
| 3.13.2 Training.....  | 25        |
| 3.13.3 Equipment .....  | 26        |
| 3.14 Emergency Procedures.....  | 27        |
| 3.15 Reporting of Accidents and Significant Incidents.....                        | 28        |
| 3.16 Investigation of Incidents.....  | 28        |
| 3.17 Work Vehicles .....  | 28        |
| 3.18 Tools.....   | 28        |
| 3.19 Flammable Liquids and Dangerous Goods .....                                  | 29        |
| 3.20 Explosives and Blasting Agents .....   | 29        |
| 3.21 Fire Equipment for Road Vehicles and Machinery .....                         | 29        |

|      |   |    |
|------|---|----|
| 4    | CHAINSAWS AND BRUSHCUTTERS .....                                  | 30 |
| 4.1  | Chainsaw Safety.....  | 30 |
| 4.2  | Chainsaw Operation.....   | 30 |
| 4.3  | Brush Cutters and Clearing Saws .....                             | 30 |
| 5    | MANUAL TREE FELLING .....   | 31 |
| 5.1  | General .....   | 31 |
| 5.2  | Separation Distances From Fellers .....                           | 31 |
| 5.3  | Driving Trees .....   | 31 |
| 5.4  | Feller's Equipment .....  | 31 |
| 5.5  | Accepted Felling Methods .....                                    | 31 |
| 5.6  | Escape Path .....   | 33 |
| 5.7  | Thinning .....  | 33 |
|      | 5.7.1 Safety Procedures .....                                     | 33 |
| 5.8  | De-limbing .....  | 33 |
| 6    | HIGHER RISK MANUAL TREE FELLING .....                             | 34 |
| 6.1  | Competency .....  | 34 |
| 6.2  | Principal Employer Obligations.....                               | 34 |
| 6.3  | Manual Felling of Hazardous Trees.....                            | 34 |
| 6.4  | Hazardous Trees .....   | 34 |
| 6.5  | Hazardous Trees – Felling Methods.....                            | 35 |
| 6.6  | Hung-up Trees .....   | 35 |
| 6.7  | Hung-up Trees Felling Methods.....                                | 35 |
| 6.8  | Marking Hazardous Trees .....                                     | 38 |
| 6.9  | Trees That Sit Back During Felling .....                          | 36 |
|      | 6.9.1 Procedure One .....   | 36 |
|      | 6.9.2 Procedure Two.....  | 37 |
|      | 6.9.3 Procedure Three .....                                       | 39 |
| 6.10 | Wind Throw .....  | 40 |
| 6.11 | Back Pulling .....  | 40 |
| 6.12 | Tree Jacking.....   | 41 |
| 6.13 | Excavator-Assisted Manual Tree Felling.....                       | 41 |
|      | 6.13.1 General Provisions .....                                   | 41 |
|      | 6.13.2 Consultation .....   | 41 |
|      | 6.13.3 Equipment .....  | 41 |
|      | 6.13.4 Capacity of Excavator .....                                | 41 |
|      | 6.13.5 Site Preparation.....                                      | 42 |
|      | 6.13.6 The Felling Operation.....                                 | 42 |
| 6.14 | Driving Trees .....   | 43 |
| 6.15 | Felling Trees with Explosives (blasting trees) .....              | 43 |
|      | 6.15.1 General Requirements .....                                 | 43 |
|      | 6.15.2 Planning Procedures.....                                   | 43 |
|      | 6.15.3 Site Preparation and Assessment.....                       | 43 |
|      | 6.15.4 Shot Firer's Responsibilities .....                        | 44 |
|      | 6.15.5 Trees Containing 'Widow Makers' .....                      | 44 |
|      | 6.15.6 Blasting Sequence .....                                    | 44 |
|      | 6.15.7 Blasting Groups of Trees .....                             | 44 |
|      | 6.15.8 Unsuccessful Blast .....                                   | 44 |
|      | 6.15.9 Misfired Charge .....                                      | 45 |
|      | 6.15.10 Unsafe Trees Following Misfired Charges or Blasting ..... | 45 |
|      | 6.15.11 Traffic Control .....                                     | 45 |
| 7    | MECHANISED FELLING .....  | 46 |
| 7.1  | General .....   | 46 |
| 7.2  | Driving Trees .....   | 46 |
| 7.3  | Machine Stability .....   | 46 |
| 7.4  | Equipment Operation.....  | 46 |
| 7.5  | Felling Difficulties.....   | 47 |
| 7.6  | Fire Suppression Equipment .....                                  | 47 |

|       |  |    |
|-------|--|----|
| 8     | <b>FIREWOOD CUTTING</b> .....  | 48 |
| 8.1   | General .....  | 48 |
| 8.2   | Uprooted Trees .....   | 48 |
| 8.3   | Driving Trees .....  | 48 |
| 8.4   | Transport of Firewood .....  | 48 |
| 8.5   | Mechanical Fire Wood Splitters.....  | 48 |
| 9     | <b>LOG EXTRACTION</b> .....  | 49 |
| 9.1   | General Provisions.....  | 49 |
| 9.2   | Cable Harvesting .....   | 49 |
| 9.3   | Log Extraction by Mobile Equipment .....                                   | 49 |
| 9.4   | Winch Cables and Rigging Equipment.....                                    | 49 |
| 9.5   | Choker Setting .....   | 49 |
| 9.6   | Forwarder Loading .....  | 49 |
| 10    | <b>MACHINERY</b> .....   | 51 |
| 10.1  | General Operations .....   | 51 |
| 10.2  | Guarding .....   | 51 |
| 10.3  | Modification of Plant and Machinery .....                                  | 51 |
| 10.4  | Maintenance of Plant and Machinery.....                                    | 52 |
| 10.5  | Machine Isolation/Parking.....   | 52 |
| 10.6  | Machine Access/Egress.....   | 52 |
| 10.7  | Mobile Plant .....   | 53 |
|       | 10.7.1 Operator Protective Structures (OPS) – Mobile Mechanical Plant..... | 53 |
|       | 10.7.2 Engineering Standards for OPS/ROPS/FOPS.....                        | 53 |
|       | 10.7.3 OPS Identification.....   | 54 |
|       | 10.7.4 Damaged OPS/ROPS/FOPS.....  | 55 |
| 10.8  | Electrical Clearance .....   | 55 |
| 10.9  | Communication Devices.....   | 55 |
| 10.10 | Operator Controls.....   | 55 |
| 10.11 | Emergency Exits.....   | 55 |
| 10.12 | Wire Rope .....  | 55 |
| 11    | <b>LOG LANDINGS</b> .....  | 57 |
| 11.1  | Planning.....  | 57 |
| 11.2  | Landing Layout.....  | 57 |
| 11.3  | Location.....  | 57 |
| 11.4  | Operating Procedures .....   | 59 |
| 11.5  | Log Stacks .....   | 59 |
| 11.6  | Log Measurement.....   | 59 |
| 12    | <b>TRANSPORTATION</b> .....  | 60 |
| 12.1  | Transportation General .....   | 60 |
|       | 12.1.1 Bush Operations – Approach to Landing.....                          | 60 |
|       | 12.1.2 Moving Vehicles .....   | 60 |
|       | 12.1.3 Vehicle Operations – Maximum Loads .....                            | 60 |
|       | 12.1.4 Correct Operation of Vehicles .....                                 | 60 |
|       | 12.1.5 Riding on Loads .....   | 60 |
|       | 12.1.6 Equipment to be Fitted to Trucks .....                              | 60 |
|       | 12.1.7 Suitable Communication Equipment .....                              | 60 |
| 12.2  | Cab Shielding (Guard) .....  | 61 |
|       | 12.2.1 Physical requirements .....   | 61 |
|       | 12.2.2 Operational requirements .....                                      | 61 |
|       | 12.2.3 Design and construction .....                                       | 61 |
| 12.3  | Rear Load Restraining Guards .....   | 62 |
|       | 12.3.1 Physical requirements .....   | 62 |
|       | 12.3.2 Operational requirements .....                                      | 62 |
|       | 12.3.3 Design and construction .....                                       | 63 |
| 12.4  | Self-Loading Trucks .....  | 64 |
| 12.5  | Loading of Logs .....  | 64 |

|        |  |           |
|--------|--|-----------|
| 12.6   | Load Requirements .....                              | 64        |
| 12.6.1 | Load Configuration.....                              | 64        |
| 12.6.2 | Load Securing .....                                  | 65        |
| 12.6.3 | Load Release and Unloading.....                      | 65        |
| 12.6.4 | Securing Jinker or Trailer.....                      | 66        |
| 12.7   | Log Restraining Equipment.....                       | 66        |
| 12.7.1 | Bolsters .....                                       | 66        |
| 12.7.2 | Chocks .....   | 66        |
| 12.7.3 | Stanchions.....                                      | 66        |
| 12.7.4 | Stanchion Extensions.....                            | 66        |
| 12.8   | Load Inspection.....                                 | 66        |
| 12.9   | Loading/Unloading of Rail Wagons .....               | 67        |
| 13     | <b>ROAD CONSTRUCTION AND MAINTENANCE .....</b>       | <b>68</b> |
| 13.1   | Construction.....                                    | 68        |
| 13.1.1 | General Provisions .....                             | 68        |
| 13.1.2 | Planning .....                                       | 68        |
| 13.1.3 | Construction .....                                   | 68        |
| 13.1.4 | Road Maintenance .....                               | 69        |
| 13.1.5 | Warning Signs.....                                   | 69        |
| 13.2   | Quarries.....  | 69        |
| 13.2.1 | Equipment Protective Structures .....                | 69        |
| 13.2.2 | Clearing of Vegetation .....                         | 69        |
| 13.2.3 | Warning Signs.....                                   | 69        |
| 13.2.4 | Blasting.....  | 70        |
| 13.2.5 | Explosives .....                                     | 70        |
| 13.2.6 | Benching.....  | 70        |
| 13.3   | Bridges.....   | 70        |
| 13.3.1 | General Provisions .....                             | 70        |
| 14     | <b>SILVICULTURE .....</b>                            | <b>71</b> |
| 14.1   | Chemical Safety .....                                | 71        |
| 14.1.1 | Hazardous Substances .....                           | 71        |
| 14.1.2 | Storage of Hazardous Substances .....                | 71        |
| 14.1.3 | Material Safety Data Sheets (MSDS).....              | 71        |
| 14.1.4 | Precautions to be Taken before Commencing Work ..... | 71        |
| 14.2   | Seed Collection.....                                 | 71        |
| 14.2.1 | General Provisions .....                             | 71        |
| 14.2.2 | Defined Seed Collecting Work Areas .....             | 72        |
| 14.2.3 | Co-joined Operations .....                           | 72        |
| 14.2.4 | Isolated Work .....                                  | 72        |
| 14.2.5 | General Precautions.....                             | 72        |
| 14.2.6 | Firearm Use.....                                     | 72        |
| 14.3   | Tree Pruning .....                                   | 73        |
| 14.3.1 | Safety Equipment .....                               | 73        |
| 14.3.2 | Ladders .....  | 73        |
| 14.3.3 | Pruning Shears .....                                 | 73        |
| 14.3.4 | Pruning Saws .....                                   | 73        |
| 14.3.5 | Pole Pruning .....                                   | 73        |
| 14.3.6 | Ultra-High Pruning .....                             | 73        |
| 14.3.7 | Mechanical Pruning .....                             | 74        |
| 14.3.8 | Chainsaw Pruning .....                               | 74        |
| 14.4   | Tree Climbing .....                                  | 74        |
| 14.4.1 | Safety Belts and Harnesses .....                     | 74        |
| 14.4.2 | Power Operated Work Platforms.....                   | 74        |
| 14.5   | Electrical Safety .....                              | 75        |
| 14.5.1 | Clearance Distances.....                             | 75        |
| 14.6   | Wind Rowing .....                                    | 76        |
| 14.6.1 | Multiple Machine/Personnel Operations .....          | 76        |
| 14.6.2 | Windrow Formation.....                               | 76        |

|       |   |           |
|-------|---|-----------|
| 14.7  | Contour Ploughing .....   | 77        |
| 15    | <b>FOREST FIRE FIGHTING .....</b>                                 | <b>78</b> |
| 15.1  | Forest Fire Management.....                                       | 78        |
|       | 15.1.1 Introduction.....  | 78        |
| 15.2  | Fire Risk Factors .....   | 78        |
| 15.3  | Briefing .....  | 78        |
| 15.4  | Fire Fighting Plan.....   | 79        |
| 15.5  | Safety Factors.....   | 79        |
| 15.6  | Physical Fitness for Fire Fighters.....                           | 79        |
| 15.7  | Competency of Fire Fighters .....                                 | 80        |
| 15.8  | Competency of Crew Leaders and Supervisors .....                  | 80        |
| 15.9  | Personal Protective Equipment and Clothing for Fire Fighters..... | 83        |
| 15.10 | Equipment Maintenance .....                                       | 81        |
| 15.11 | Fire fighting Equipment .....                                     | 81        |
| 15.12 | Fire fighting Lookout Towers .....                                | 81        |
| 15.13 | Prescribed Burning .....  | 84        |
|       | 15.13.1 Aim.....  | 84        |
|       | 15.13.2 Planning .....  | 84        |
|       | 15.13.3 Briefing.....   | 81        |
|       | 15.13.4 Lighting .....  | 82        |
| 15.14 | Fire Fighting Operations .....                                    | 85        |
| 16    | <b>HUMAN FACTORS .....</b>  | <b>84</b> |
| 16.1  | Fatigue .....   | 84        |
| 16.2  | Dehydration.....  | 84        |
| 16.3  | Ergonomics.....   | 84        |
| 16.4  | Mental Fatigue.....   | 85        |
| 16.5  | Fitness for Work.....   | 85        |
| 16.6  | Nutrition .....   | 85        |
| 16.7  | Heat Stress.....  | 85        |
| 16.8  | Vibration .....   | 85        |
| 16.9  | Atmospheric Contaminants .....                                    | 86        |
| 16.10 | Ultraviolet Radiation (UVR) Exposure .....                        | 86        |
| 16.11 | Noise .....   | 86        |
|       | APPENDIX 1 – GENERAL OBLIGATIONS .....                            | 87        |
|       | APPENDIX 2 – FOREST OPERATIONS SAFETY PLAN (FOS PLAN).....        | 95        |
|       | APPENDIX 3 – TFITB INDUSTRY COMPETENCY STANDARDS .....            | 96        |
| 17    | <b>DEFINITIONS .....</b>  | <b>97</b> |
|       | 17.1 References .....   | 106       |
|       | 17.2 Code Development Members .....                               | 107       |

## PREFACE

With the proclamation of the *Workplace Health and Safety Act 1995* and the making of the performance-based *Workplace Health and Safety Regulations 1998*, the need for industry-based guidance standards was recognised by the Forest Safety Advisory Group (FSAG) to help the forest industry identify and manage hazards encountered in forestry operations.

The FSAG group consisted of members from the forest industry, trade unions, training providers, contractors and government representatives.

Forest operations have historically presented a considerable number of 'high risk' hazards for operators, with many employees suffering fatal or debilitating injuries.

The development of the draft Forest Safety Code (Tasmania) 2002 commenced under the auspices of the FSAG Executive. This group invited members to develop initial safe operating procedures and hazard controls, covering 18 critical areas of the forest industry.

A tripartite Expert Review Group, drawn from the FSAG membership, was formed to conduct a review of the initial draft documentation, also taking into consideration national codes, Australian standards and industry standards.

The resulting draft Code of Practice was prepared by the Expert Review Group and released for a two-month public comment period.

A further review of the draft was undertaken by the tripartite Expert Review Group, taking into account comments received during the public comment phase, and amendments made to the original draft document.

This final document is released following the Minister's approval under section 22 of the *Workplace Health and Safety Act 1995*.

The review of the Forest Safety Code (Tasmania) 2002 was commenced in January of 2006 by the Safety Standards Committee (the Committee) of the Tasmanian Forest Industries Training Board (TFITB). The committee consisted of members from the forest industry, trade unions, training providers, workplace safety and forest contractors.

The Committee acknowledges that this document will not provide guidance on every occupational health and safety situation that occurs in the forest industry. Hazards that have the potential for serious risk must be managed in accordance with the principles of hazard identification, risk assessment and implementation of controls to minimise risk, as required by legislation.

This document references a number of relevant Australian Standards, other State and Commonwealth legislation and codes of practice. The referencing of these documents will ensure that the code remains current when amendments to relevant legislation and standards occur.

The TFITB will continue to develop industry competency standards for forest tasks to national or equivalent Tasmanian forest industry standards.

This code addresses many safety issues within the format of 'general principles of safety'; these principles identify hazards that occur across a number of forest operations.

It is recommended by the Committee that this code of practice be reviewed after three years.



## SCOPE

The Forest Safety Code (Tasmania) 2007 applies to all workplaces where forest operations are conducted, and covers:

- a. the formation, development, regeneration and maintenance of forests;
- b. the obtaining of forest produce;
- c. the loading, transport and unloading of forest produce;
- d. post operative assessment;
- e. the establishment, maintenance and repair of roads or tracks in connection with that work; and
- f. all persons with potential for exposure to hazards resulting from forest operations in those workplaces.

This code should be read in conjunction with the *Workplace Health and Safety Act 1995*, the *Workplace Health and Safety Regulations 1998* and any other legislation and Australian Standards referenced in this Code of Practice.

The Forest Safety Code (Tasmania) 2007 is to be approved under s.22 (1) of the *Workplace Health and Safety Act 1995*.

This code does not replace the requirements of the Forest Practices Code (2000).

## **PURPOSE**

The purpose of the Forest Safety Code (Tasmania) 2007 is to provide practical guidance for safe work practices and the prevention of injury in workplaces where persons are engaged in forest operations.

Risk to personnel and equipment should be as low as is reasonably practicable to achieve the requirements of 'Duty of Care' as defined in the *Workplace Health and Safety Act 1995* and the *Workplace Health and Safety Regulations 1998*.

## **STANDARDS AND CODES OF PRACTICE**

Where reference is made to a Code of Practice or Standards, persons may refer to any other standard embodying the same or more stringent criteria.

## WHAT IS A CODE OF PRACTICE?

The term 'Code of Practice' has a particular meaning under the *Tasmanian Workplace Health and Safety Act 1995* (the Act). In particular the Act {section 22 (2)} states:

*'a code of practice may consist of any code, standard, rule, specification, or provision relating to workplace health and safety formulated, prepared or adopted by the Director and may apply, incorporate or refer to any document formulated or published by any body or authority as in force at the time the code of practice is approved or as amended, formulated or published from time to time.'*

Other codes of practice, such as the codes developed by the National Occupational Health and Safety Commission or Standards Australia, voluntary codes agreed in an industry, or codes adopted by other states or countries, do not come within the meaning of the term used in the Act unless called up as an approved code of practice. The Act {section 22 (1)} provides for approved Codes of Practice

*'for the purpose of providing practical guidance to employees, employers and any other person on whom a duty of care is imposed under this Act.'*

Provisions in a code constitute compliance either with the provisions of the Act or with a regulation to which the code is giving practical guidance. The provisions in a code are, however, not mandatory. That is, a person may choose to comply with the relevant provisions of the Act or regulation in some other way, provided that the alternative method used also fulfils the requirements of the Act or Regulations.

A Code of Practice approved by the Minister comes into effect when notice of approval is published in the *Gazette* and three major Tasmanian daily newspapers {section 22 (5)}. A Code of Practice does not have the same legal force as Regulations. Contravention of, or failure to comply with, Regulations made under the Act is an offence {section 57 (4)}. Failure to observe a provision of an approved Code of Practice is not in itself a breach of the Act {section 22 (10)}. However, an approved Code of Practice is admissible as evidence in legal proceedings in which it is alleged that a person with a 'duty of care' under the Act has failed to comply with an approved Code of Practice; this constitutes proof of a breach of duty of care responsibility, unless it can be shown that the actions taken were at least equivalent to those described in the approved Code of Practice.

An Inspector may cite an approved Code of Practice as a means of remedying non-compliance when issuing an Improvement Notice or Prohibition Notice under the Act {section 39 (1)}.

## ABBREVIATIONS USED

|          |                      |
|----------|----------------------|
| s.9      | Section 9            |
| ss.9-19  | Sections 9 to 19     |
| r.17     | Regulation 17        |
| rr.18-20 | Regulations 18 to 20 |

# 1 LANGUAGE

In a Code of Practice, certain words are used that determine the level of choice available to the user.

To assist in clarifying this specific word usage, the following definitions and examples are provided:

## MUST

Where a clause contains the word **must**, then the requirement is contained within the **Workplace Health and Safety Act 1995** (the Act) or the **Workplace Health and Safety Regulations 1998**. This means that you have no other option than to do what the clause requires.

### **Example:**

A person **must** not operate a docking saw unless that person has been instructed in the dangers and received training in the safe operating procedures of the saw [*Workplace Health and Safety Act 1995-s.9(1)(a)*].

## IS TO/ARE TO

If a clause says a person is to, or persons are to, do something, then you are being instructed to do it, but in these situations you have a choice. This situation is unique to codes of practice approved under s.22 of the Act.

Codes of practice provide flexibility in this instance to allow practical and innovative solutions to be developed in the workplace. When an alternative solution is developed to that contained in the code, you will need to conduct a risk assessment to determine if the alternative is *equal to or better than* the instruction within the Code of Practice, and you could be required to prove it.

### **Example:**

Circular saws **are to** be guarded.

## SHOULD

When **should** is used in a clause, you are being advised to do something but it is up to you whether you do it or not. If you decide not to adopt the advice, then you need to have conducted a risk assessment to support your decision.

### **Example:**

Start buttons **should** be green.

Some clauses in a code of practice refer to other documents, such as Australian Standards. If this occurs, then the application of the specific provision of the Standard is determined by the words used in the particular referencing clause of the code of practice.

If the code says you **must** comply with the Standard, then you interpret the standard just like the code. 'Must', 'is to' and 'should' have exactly the meanings shown above.

If the code requires that the Standard **is to** be complied with, then a reference in the Standard to **must** is to be read as **is to** in the Standard.

If the code says a Standard should be complied with or used as guidance, then you may treat every provision contained in the Standard as a **should** provision.

## 2 LEGAL FRAMEWORK AND GENERAL DUTIES

### 2.1 DUTIES OF EMPLOYERS

All employers and employees **must** comply with the *Workplace Health and Safety Act 1995* and the *Workplace Health and Safety Regulations 1998*.

An employer **must**, so far as is reasonably practicable, provide and maintain:

- a. a safe work environment;
- b. safe systems of work; and
- c. plant and substances in a safe condition.

An employer **must** also provide, so far as is reasonably practicable, such information, instruction, training and supervision to employees as are necessary to enable the employees to perform their work in a manner that is safe from injury and risk.

Refer AS/NZS 4804 1997 *Occupational Health and Safety Management Systems – Guidelines* and AS/NZS 4801 2000 *Occupational Health and Safety Management System – Specification with guidance for use*.

### 2.2 DUTIES OF DESIGNERS, MANUFACTURERS, IMPORTERS, SUPPLIERS AND INSTALLERS

A person who designs, manufactures, imports or supplies any plant for use at the workplace **must**:

- a. ensure that the design and construction of the plant are safe; and
- b. supply adequate information to allow the safe use of the plant.

### 2.3 DUTIES OF EMPLOYEES

While at work, an employee **must**:

- a. take all reasonable care for the employee's own health and safety, and that of other persons at the workplace; and
- b. comply with directions given by the employer, supervisor or person in charge.

### 2.4 HAZARD IDENTIFICATION AND RISK MANAGEMENT

The *Workplace Health and Safety Regulations 1998* (rr.17, 18, 19.) require that a person in charge **must**, as far as is reasonably practicable:

- a. identify all hazards arising, or that may arise, in a workplace;
- b. assess the risk associated with those hazards; and
- c. implement appropriate measures to control that risk.

A 'person in charge' in a workplace may be any person who has a responsibility or an obligation for the health and safety of any other person or persons in the workplace.

### 3 GENERAL PRINCIPLES OF SAFETY

These principles **are to** be observed by all persons employed, engaged in, or visiting any forest operation. All persons **are to** acquaint themselves with the relevant safety provisions of this code for each operation and **must** take all necessary precautions to ensure their own safety and the safety of others engaged in each particular operation.

#### 3.1 SAFETY PLANNING

All forest operations **should** be thoroughly planned, developed and organised in advance to ensure that all parties to the forest operation are aware of the health and safety requirements of the workplace.

A **Forest Operations Safety Plan (FOS plan)** **must** be developed for new forest operations (refer FOS plan criteria Appendix 2).

A safety management system for hazard control which includes a forest operations risk-rating method (refer to an example of a **Risk Analysis Work Sheet** Appendix 1) acceptable to all parties **should** be available to enable modifications to the Forest Practices Plan or operational plan where risk has been identified as unacceptable.

Before starting forest operations at a new workplace the person in charge **must** conduct a hazard identification and risk assessment of the proposed operation.

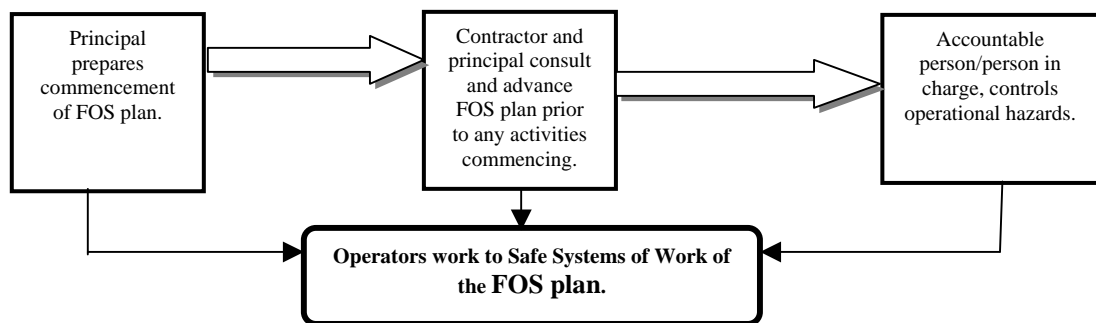

The person in charge **must** record all significant identified hazards on the risk assessment after the site inspection, and implement control measures to keep the risk to personnel at an acceptable level (*Workplace Health and Safety Regulations 1998* r.19).

Where an unacceptable risk remains from a hazard, the hazard **is to** be taped off at a safe distance and all personnel made aware of the exact location of the hazard before starting or continuing operations.

The person in charge **must** conduct a briefing with workers before starting work, informing them of details of the risk assessment and providing directives on how to control the hazards identified (*Workplace Health and Safety Act 1995* s.9).

#### 3.2 ROLES AND RESPONSIBILITIES

All persons on forest operations should have their roles and responsibilities clearly defined.

Employees' roles and responsibilities may make them responsible officers under the *Workplace Health and Safety Act 1995* s.11, or accountable persons under the *Workplace Health and Safety Regulations 1998* r.5, or a person in charge under the Forest Safety Code.

### 3.3 SUPERVISION

Every employer **must** nominate a person to be in charge of each operation, and that person **must** exercise such supervision as to ensure that the work is performed in a safe manner at all times (*Workplace Health and Safety Act 1995 s.9*).

Where any forest operation becomes dangerous because of high winds, wet weather, poor visibility or other adverse environmental conditions, the person in charge **should** suspend all operations while such conditions exist.

When unexpected hazards are encountered or a task cannot be performed due to an identified unacceptable risk, work **must** be stopped and the person in charge consulted on how to proceed (*Workplace Health and Safety Act 1995 s.9*).

Where several employers or self-employed persons work on the same site, the person in charge **should** ensure coordination, and assign and communicate responsibility for supervision (*Workplace Health and Safety Act 1995 s.9*).

All employees **should** acquaint themselves with the relevant safety provisions of this code for each operation, and **must** take all necessary precautions to ensure their own safety and the safety of others engaged in each particular operation.

### 3.4 WORKING ALONE

The employer **is to** assume the responsibility of work assignments so that no employee will be required to work in a position or location so isolated that that employee is not within visual or audible signal contact with another person or have an appropriate emergency plan.

Exceptions to this requirement may be made for workers provided with two-way radios, mobile telephones or any other effective means of communication.

### 3.5 WORKING AT NIGHT

Where any forest operation is conducted during the hours of darkness the immediate work area **is to** be provided with adequate illumination.

### 3.6 ROAD ACCESS RESTRICTIONS

When forest operations are carried out along roads that may place road users at risk, the appropriate traffic control measures **should** be used so as to ensure the safety of all road users. The length of the road closure **should** be agreed upon beforehand with the relevant authorities. When a road has been closed by a barrier, an appropriate sign indicating 'ROAD CLOSED' **must** be included. Signs **are to** comply with AS 1319 Safety signs for the occupational environment and AS 1742 Manual of uniform traffic control devices. Part 2: Traffic control devices for general use.

### 3.7 EMPLOYEE INDUCTION

The employer **must** give all new employees induction training when they start work (*Workplace Health and Safety Act 1995 s.9*). This training **should** take place on the job, with specialist training being provided when appropriate.

## 3.8 TRAINING

### 3.8.1 General

Training **is to** be provided in accordance with *Workplace Health and Safety Regulations 1998*.

***This does not preclude on-the-job training of employees by the employer to ensure safety of persons in forest operations.***

Employers **are to** ensure that all workers are adequately instructed and trained in the work tasks they are required to perform and the dangers or hazards involved in each task (*Workplace Health and Safety Act 1995 s.9*).

### 3.8.2 Supervision of Trainees

When an employer hires an inexperienced employee, the employer **must** provide the instruction or training required, and ensure appropriate supervision until the employee demonstrates their competence (to a competent person) to work safely in the job they are to perform.

At all times a trainee undertaking tree felling **must** be under supervision.

### 3.8.3 Training Objectives

No persons **are to** perform forestry work unless they have the required level of skill and knowledge to perform the task.

Before initial assignment to a specific task, all forest workers must undergo appropriate training.

This training **should** have clearly defined learning objectives, and be conducted by a suitably qualified instructor or a person with suitable experience in the work to be performed.

### 3.8.4 Training Programs

An effective training program **should** have the following features:

- a. a careful analysis of training needs which identifies the tasks to be performed and the knowledge, skills and attitudes required;
- b. identification of the correct competency standards to be achieved as a result of training; and
- c. a program design which encompasses:
  - i. entry standards for learners;
  - ii. learning objectives;
  - iii. selection of training media;
  - iv. adequate testing; and
  - v. evaluation of results in relation to their usefulness to the industry.



### 3.8.5 *Changed Operations*

Appropriate information **is to** be given to all employees when any changes in work conditions or methods of work are introduced (*Workplace Health and Safety Act 1995 s.9*).

## 3.9 OPERATOR COMPETENCY STANDARDS

A principal or employer **must** ensure that any forest worker who undertakes any specific task or uses any machinery or equipment specified in the TFITB's Forest Operator Assessment and Licensing Scheme has been assessed as competent to carry out the task. A principal or employer should have a record of operators qualifications on site at all times.

**Exception:** A person may carry out (or permit a person employed or engaged by that person to carry out) any forest operation where the person:

- a. is undergoing training necessary to pass an assessment of their competence conducted for the purpose of an approved course of training or an assessment; and
- b. is operating under the supervision and instruction of another person who has completed an approved course of training or satisfied an assessment applicable to the safety of that particular operation.

All workers assessed as competent by approved assessors to undertake 'specific tasks' specified in the TFITB Forest Operator Assessment and Licensing Scheme **are to** be issued with a Tasmanian Forest Industries Training Board Licence showing each specified competency.

When an employer hires an experienced, accredited worker, the new employee **should** be required to demonstrate to the employer, or the person in charge, their competence to safely accomplish the work they may be asked to do.

Refer to the list of approved competency licences/tasks issued by the Tasmanian Forest Industries Training Board (Appendix 3).

## 3.10 PERSONAL PROTECTIVE EQUIPMENT AND CLOTHING (PPE&C)

Personal protective equipment and clothing suitable to the work being performed **must** be worn, or used as required, to control exposure to an identified hazard.

Employees **must** wear and maintain the equipment or clothing and **must** not deliberately damage or misuse it.

Personal protective equipment and clothing **must** be maintained in a safe and effective condition or removed from service or use (*Workplace Health and Safety Regulations 1998 r.58*).

### 3.10.1 Head Protection

An industrial safety helmet and appropriate accessories conforming to AS/NZS 1801 Occupational protective helmets and AS 1800 Occupational protective helmets – Selection, care and use **must** be worn by each person exposed to the risk of head injury.

Note: Climbing helmets complying with DIN 7948/EN 12492 are a suitable alternative to helmets complying with AS 1801 for pruning operations.

An employer need not provide a helmet when there is no likelihood of the person being struck by objects falling from above.

### 3.10.2 Safety Footwear

Appropriate crush-resistant safety footwear conforming to AS/NZS 2210 Occupational protective footwear or any other relevant standard or prescribed authority **must** be worn by all persons engaged in forest operations where exposed to crushing or laceration injuries.

Where a risk assessment shows that it is reasonably practicable, cut-resistant footwear may be suitable for chainsaw operation where laceration hazards exist.

### 3.10.3 Hearing Protection

All persons engaged in forest operations **must** use hearing protection complying to AS/NZS 1270 Acoustics Hearing protectors, when exposed to noise hazards measured in accordance with AS 1269 Occupational Noise Management.

### 3.10.4 Leg Protection

Protective clothing conforming to AS/NZS 4453 Leg protection for users of hand held chainsaws **must** be worn by chainsaw operators exposed to chainsaw laceration hazards.

### 3.10.5 Hand Protection

Gloves conforming to AS/NZS 2161 Occupational protective gloves **should** be worn by employees when handling wire rope or rough material, or when the nature of the work requires protection from hazards to the hands.

### 3.10.6 Eye Protection

Eye protection conforming to AS/NZS 1336 & AS/NZS1337 Recommended practices for occupational eye protection **must** be worn by all persons who may be exposed to risk of eye injury.

### 3.10.7 High Visibility Safety Garments

An outer garment conforming to AS/NZS 4602 High visibility safety garments **must** be worn at all times when a person is at a forest operation *other than for fire fighting operations*. Refer to section 15.9.

### 3.10.8 Respiratory Protection

Suitable respiratory devices conforming to AS/NZS 1716 Respiratory protective devices, **must** be worn where persons engaged in forest operations are exposed to atmospheric contaminants in excess of levels identified in the National Occupational Health and Safety Commission's Exposure Standards for the Atmospheric Contaminants in the Occupational Environment (NOHSC:1003).

The respirator devices provided **must** be cared for and maintained in accordance with AS/NZS 1715 Selection, use and maintenance of respiratory protective devices.

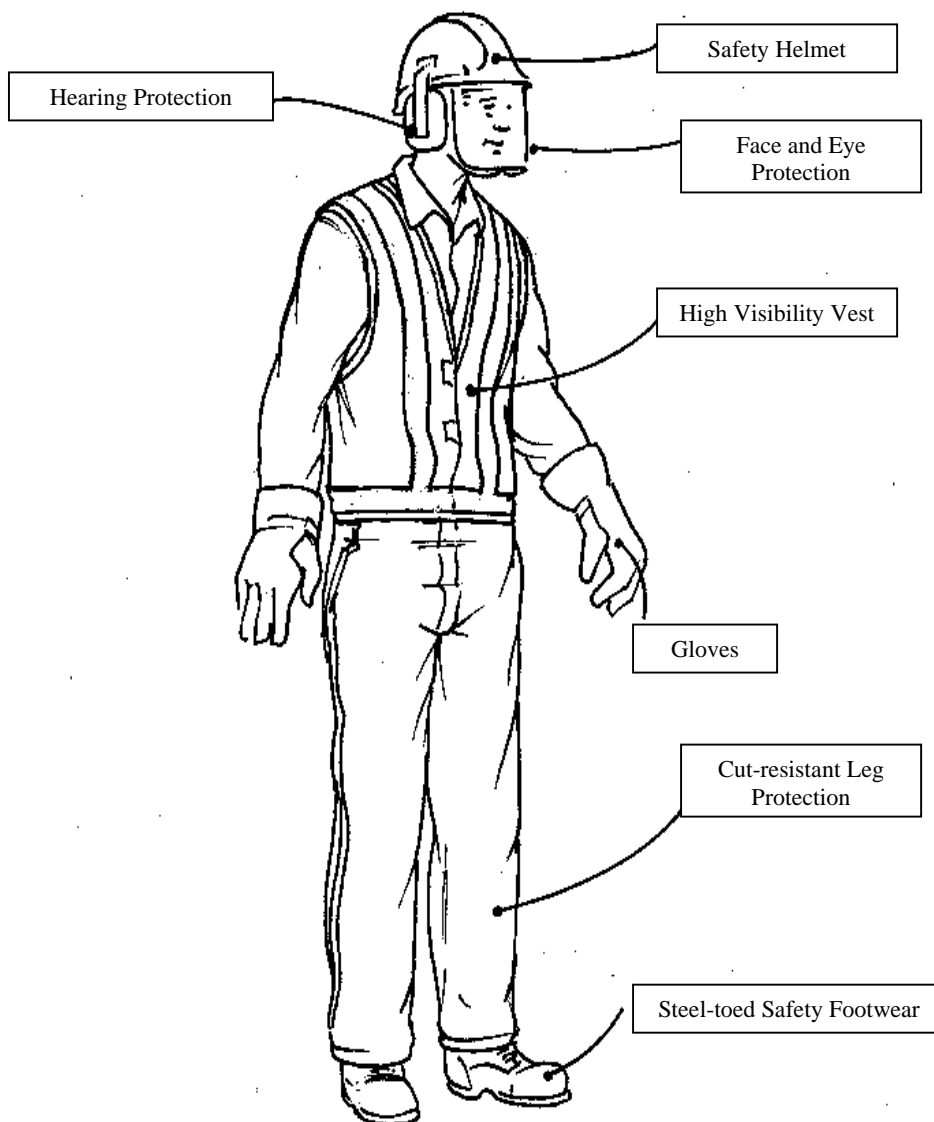

*Figure 1*  
**Personal Protective Equipment and Clothing**

The recommended personal protective equipment and clothing for control of risk in a range of specific tasks in forestry operations is detailed in Table 1.

**Table 1 – Personal Protective Equipment and Clothing Appropriate for Forestry Operations**

| PART OF BODY TO BE PROTECTED:                          | FOOT                      | LEG                          | TRUNK                | HAND  | HEAD           | EYE                     | EYE/FACE        | HEARING PROTECTIVE DEVICES <sup>3, 4</sup> |
|--|---------------------------|------------------------------|----------------------|---|----------------|-------------------------|-----------------|--|
| PPE NORMALLY APPROPRIATE                               | SAFETY BOOTS <sup>1</sup> | SAFETY TROUSERS <sup>2</sup> | HI VIZ <sup>10</sup> | GLOVES  | SAFETY HELMET  | GOGGLES/ SAFETY GLASSES | VISOR (MESH)    |  |
| <b>Operation</b>                                       |                           |                              |                      |   |                |                         |                 |  |
| <i>Planting</i>  |                           |                              |                      |   |                |                         |                 |  |
| Manual   | ✓                         |                              | ✓                    |   |                |                         |                 |  |
| Mechanised   | ✓                         |                              | ✓                    |   |                |                         |                 | ✓ <sup>4</sup>                             |
| <b>Weeding/ Cleaning</b>                               |                           |                              |                      |   |                |                         |                 |  |
| Smooth-edged Tools                                     | ✓                         |                              | ✓                    | ✓   |                |                         |                 |  |
| Handsaw  | ✓                         |                              | ✓                    | ✓   |                |                         |                 |  |
| Chainsaw   | ✓ <sup>5</sup>            | ✓                            | ✓                    | ✓   | ✓              | ✓                       | ✓               | ✓  |
| Brush cutter - with metal blade                        | ✓                         | ✓                            | ✓                    | ✓   | ✓              | ✓                       | ✓               | ✓  |
| - with nylon filament                                  | ✓                         | ✓                            | ✓                    | ✓   | ✓              | ✓                       | ✓               | ✓  |
| Rotating knife/flail                                   | ✓                         | ✓                            | ✓                    | ✓   | ✓              | ✓                       | ✓               | ✓ <sup>4</sup>                             |
| <i>Pesticide application Pruning / Seed Collection</i> |                           |                              |                      | To comply with those specified for the particular substance and application technique |                |                         |                 |  |
| Hand tools   | ✓ <sup>5</sup>            |                              | ✓                    | ✓ <sup>13</sup>   | ✓ <sup>6</sup> | ✓                       |                 |  |
| <b>Felling</b>   |                           |                              |                      |   |                |                         |                 |  |
| Hand tools   | ✓                         |                              | ✓                    | ✓ <sup>8</sup>  | ✓              | ✓                       | ✓ <sup>16</sup> |  |
| Chainsaw   | ✓                         | ✓                            | ✓                    | ✓   | ✓              | ✓                       | ✓               | ✓  |
| Mechanised   | ✓                         |                              | ✓                    |   | ✓              |                         |                 | ✓  |
| <b>Debarking</b>                                       |                           |                              |                      |   |                |                         |                 |  |
| Manual   | ✓                         |                              | ✓                    | ✓   | ✓              |                         |                 |  |
| Mechanised   | ✓                         |                              | ✓                    | ✓   |                | ✓                       |                 | ✓ <sup>4</sup>                             |
| <b>Splitting</b>                                       |                           |                              |                      |   |                |                         |                 |  |
| Mechanised   | ✓                         |                              | ✓                    | ✓   |                | ✓                       |                 | ✓  |

| PART OF BODY TO BE PROTECTED             | FOOT                      | LEG                          | TRUNK                | HAND           | HEAD                | EYE                     | EYE/FACE        | HEARING PROTECTIVE DEVICES |
|--|---------------------------|------------------------------|----------------------|----------------|---------------------|-------------------------|-----------------|----------------------------|
| PPE NORMALLY APPROPRIATE                 | SAFETY BOOTS <sup>1</sup> | SAFETY TROUSERS <sup>2</sup> | HI VIZ <sup>10</sup> | GLOVES         | SAFETY HELMET       | GOGGLES/ SAFETY GLASSES | VISOR (MESH)    |                            |
| <b>Extraction</b><br>Mechanised          |                           |                              |                      |                |                     |                         |                 |                            |
| Skidder/Dozer/<br>Excavator              | ✓                         |                              | ✓                    | ✓ <sup>9</sup> | ✓                   |                         |                 | ✓ <sup>4</sup>             |
| - Forwarder                              | ✓                         |                              | ✓                    |                | ✓                   |                         |                 | ✓ <sup>4</sup>             |
| - Cable Crane                            | ✓                         |                              | ✓                    | ✓ <sup>9</sup> | ✓                   |                         |                 | ✓ <sup>4</sup>             |
| Stacking/<br>Loading                     | ✓                         |                              | ✓                    | ✓              | ✓                   |                         |                 | ✓ <sup>4</sup>             |
| Chipping                                 | ✓                         |                              | ✓                    | ✓              | ✓                   |                         | ✓               | ✓ <sup>4</sup>             |
| <b>Tree Climbing</b><br>using a chainsaw | ✓ <sup>5</sup>            | ✓                            | ✓                    | ✓              | ✓ <sup>11, 12</sup> | ✓                       |                 | ✓                          |
| not using a chainsaw                     | ✓                         |                              | ✓                    | ✓              | ✓                   |                         |                 |                            |
| Transport                                | ✓                         |                              | ✓                    | ✓              | ✓                   |                         |                 |                            |
| Visitors                                 |                           |                              | ✓                    |                | ✓                   |                         |                 |                            |
| Fire Fighting                            | ✓                         | ✓ <sup>14</sup>              | ✓                    | ✓              | ✓ <sup>14</sup>     | ✓                       |                 |                            |
| Roading                                  | ✓                         |                              | ✓                    |                | ✓                   |                         | ✓ <sup>15</sup> | ✓ <sup>4</sup>             |
| Quarrying                                | ✓                         |                              | ✓                    |                | ✓                   |                         | ✓ <sup>15</sup> | ✓ <sup>4</sup>             |

- 1 With integrated steel toe for medium or heavy loads and **should** provide adequate ankle support.
- 2 Safety trousers or chaps incorporating clogging material.
- 3 Earplugs and ear valves not generally suitable for forestry because of risk of infection.
- 4 When noise level at work position exceeds 85 dB (A).
- 5 When falling branches are likely to cause injury.
- 6 When pruning.
- 7 Felling includes debranching and crosscutting.
- 8 When using a handsaw.
- 9 Only if manipulating logs; gloves with heavy-duty palm if handling wire choker rope, tether line or chain.
- 10 Highly visible colours.
- 11 With chin strap.

- 12 Climbing helmets are preferable; if they are not available, safety helmets with chin straps may be used.
- 13 Seed collectors **should** wear a cut resistant glove on the free hand.
- 14 Refer to Fire Fighting section 15.9 for appropriate clothing.
- 15 Where an unacceptable risk exists.
- 16 Visor must only be used for low impact application.

Adequate protective clothing **is to** be worn where there is a risk of UV radiation or biological hazards.

Long hair **should** be confined in such a manner as to prevent it being caught by any moving part of any plant or machinery.

### 3.11 FOREST OPERATIONS SIGNAGE

All signs and/or traffic control devices are to be positioned so as to be readily visible and to provide adequate time for road users to respond.

#### 3.11.1 Tree Felling Operations

As a minimum, signs are to read 'Danger – Tree Felling Ahead' or 'Danger – Forest Operations Ahead'. 'Danger' is to be in red letters at least 150 millimetres in height. The remainder of the lettering is to be in black letters at least 100 millimetres in height on a white background with a minimum size of 900mm x 600mm.

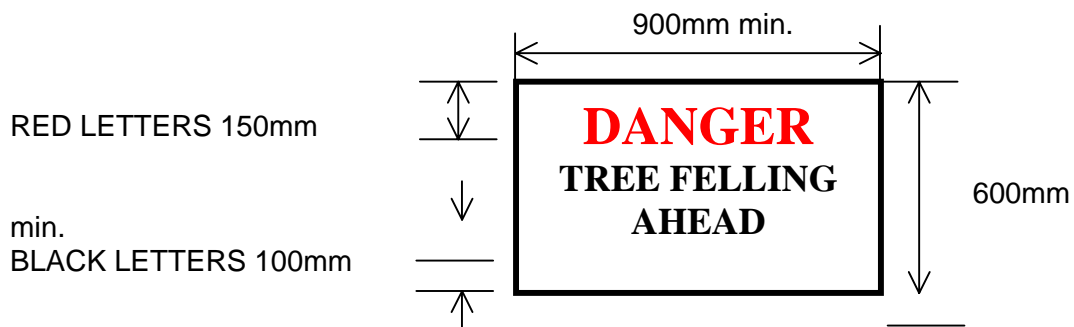

#### 3.11.2 Forest Operations Not Involving Tree Felling

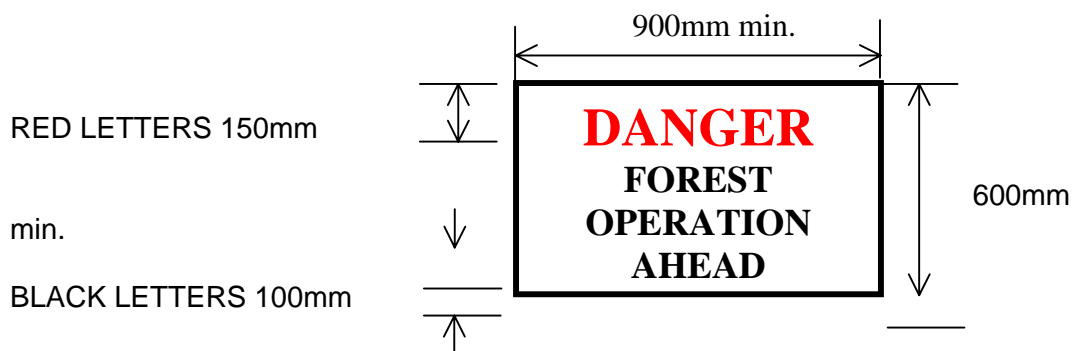

Diagram 1  
Signage

#### 3.11.3 Visitor Control

Forestry operations are a potential threat to the safety of visitors and the general public. Appropriate signage to indicate safety equipment and visitor control procedures in accordance with AS 1319 Safety signs for the occupational environment must be displayed at each forest operation (*Workplace Health and Safety Regulations 1998* r.59).



All forest operations **must** have a suitable system for the control of all visitors to the workplace {*Workplace Health and Safety Act 1995*, s.9 (8)}. Unauthorised visitors to the workplace are to be assumed to be unaware of the hazards of forest operations and are to be managed by the person in charge of the workplace according to their Safety Management System procedure for such visitors.

The person in charge of the forest operation **should** ensure that all visitors:

- a. comply with the conditions on the signs at the entrance to the forest operations;
- b. report to the person in charge (or their nominee) who will inform the visitor of the safety procedures to be followed before entering the forest operation; and
- c. wear appropriate protective equipment as required by the signage.

Signage for low risk forest operations may replace the word 'DANGER' with the word 'CAUTION'.

### 3.12 ON-SITE AMENITIES

Adequate shelter that provides protection from adverse weather conditions **should** be located at each workplace.

The shelter **is to** be of sufficient size to accommodate the number of persons intending to use it, and is to have the following:

- a. adequate seating;
- b. adequate heating;
- c. entry and exit to be located so as to allow safe passage for workers;
- d. a location that **should** not be affected by any part of the work process; and
- e. a location that is free of hazardous trees.

Where overnight camping occurs, all of the above are applicable, and appropriate sanitary and washing facilities **are to** be made available *Workplace Health and Safety Regulations 1998* r.116).

**Note:** Where forestry operations are located in areas that are subject to a high level of public exposure, sanitary accommodation **is to** be in accordance with the *Workplace Health and Safety Act 1995* and *Workplace Health and Safety Regulations 1998* r.116.

### 3.13 FIRST AID

#### 3.13.1 General

The employer **must** provide for the immediate and emergency care of ill or injured employees {*Workplace Health and Safety Act 1995* s.(9)(1)(b) and *Workplace Health and Safety Regulations 1998* r.24}.

#### 3.13.2 Training

An accredited workplace level 2 or higher first aid person **must** be on site and a suitable first aid kit **must** be immediately available on any forest operation.

The accredited first aid person **should** be responsible for the procedures to be followed when dealing with injured persons.

The employer must ensure that an appropriate level of First Aid training is received by other employees to ensure an appropriate response in the event of injury to, or absence from the workplace of the accredited workplace Level 2 First Aider.

### 3.13.3 Equipment

A vehicle **must** be kept available for transport at all times while work is in progress.

First aid supplies **must** be stored in containers adequate to protect the contents from damage, deterioration or contamination. These containers **must** be clearly marked and immediately available, and should contain nothing other than first aid equipment. An assessment must be completed for the task being undertaken to determine the appropriate first aid supplies. The recommended requirements for first aid supplies are:

**Note:** For further guidance material, see the Workplace Standards Tasmania publication "A Guide to First Aid in the Workplace".

**Table 2 – Field Trauma First Aid Kit**

| Item   | Quantity         |
|--|------------------|
| Antiseptic cleansing solution                                    | 1 bottle (100ml) |
| Antiseptic cream   | 1 tube (50g)     |
| Adhesive plastic dressing strips                                 | 1 packet 50      |
| Adhesive strapping, 75 mm wide                                   | 1 roll           |
| Gauze swabs, 100 mm x 100 mm                                     | 3 packets of 5   |
| Conforming roller bandages, 50 mm wide                           | 2                |
| Conforming roller bandages, 75 mm wide                           | 2                |
| Triangular bandages  | 8                |
| Large wound dressing No. 15                                      | 2                |
| Small wound dressing No. 13                                      | 2                |
| Non adhesive dressing 100mm x 100mm                              | Packet of 3      |
| Crepe bandage (100 mm wide) heavy duty                           | 1                |
| Constrictive bandage, 50 mm x 1 mm (rubber)                      | 1 (optional)     |
| Eye wash (single use sterile tubes)                              | 6 tubes          |
| Eye pads, sterile  | 4                |
| Pair of shears, 75 mm s/steel                                    | 1                |
| Splinter probe (disposable)                                      | 1 packet         |
| Forceps stainless steel blunt 12.5cm                             | 1                |
| Safety pins  | 1 packet of 12   |
| Thermal blanket (aluminium foil)                                 | 1                |
| Hygienically clean zip lock plastic bags (small, medium & large) | 2 of each        |
| Resuscitation mask   | 1                |
| Gloves (disposable)  | 1 packet of 10   |
| First Aid Instruction pamphlet                                   | 1                |

**Table 3 – Forestry One-Person First Aid Kit  
(for persons working alone on forest operations)**

| <b>Description</b>                     | <b>Quantity</b> |
|--|-----------------|
| Adhesive strips                        | 1 packet of 25  |
| Triangular bandage                     | 1               |
| Prepared wound dressing No. 14         | 1               |
| Prepared wound dressing No. 15         | 1               |
| Forceps stainless steel s/blunt 12.5cm | 1               |
| Safety pins                            | 1 packet of 12  |
| Crepe bandage 10cm heavy duty          | 2               |
| Splinter probe (disposable)            | 1 packet        |
| Gloves (disposable)                    | 1 packet 4      |
| Eye wash (steri tubes)                 | 2               |
| Non adhesive dressing 100mm x 100mm    | 1               |
| Thermal blanket (aluminium foil)       | 1               |
| First Aid Instruction pamphlet         | 1               |

**Table 4 – Feller’s Personal First Aid Requirement**

| <b>Description</b>             | <b>Quantity</b> |
|--------------------------------|-----------------|
| Prepared wound dressing No. 15 | 1               |

All employees **must** be informed of the location of the first aid supplies and the procedures for replacement of stock (*Workplace Health and Safety Act 1995* s.9(2)(c)).

### 3.14 EMERGENCY PROCEDURES

The key to satisfactory emergency response is pre-planning for emergencies. The following steps **should** be taken before work starts on forest operations:

- a. Ensure that communications operate efficiently.
- b. Test the communication system from the workplace to a reliable response centre.
- c. Ensure that local facilities are adequate to cover the worst possible scenario.
- d. Ensure that there is sufficient first aid equipment and accredited first-aiders are available at the workplace to sustain life until further help arrives or to confine damage until adequate resources can be delivered.
- e. Ensure that the listed Emergency Meeting Point reference number is appropriate for the location of the workplace (reference number and location **are to** be known to all staff, and **are to** be prominently displayed at the workplace).
- f. All staff who are going to be, or are likely to be, on site **must** be informed of the phone number/contacts to be made in case of emergency.
- g. Arrange special transport requirements necessary for evacuation of people or machinery.
- h. Arrange for a backup emergency contact system, in case of failure of the primary system (e.g. location of nearest farmhouse, mobile phone transmission point).
- i. Ensure that there are adequate ‘man down’, ‘working alone’ and ‘failure to return’ procedures in place.
- j. Planned responses **should** be practised for all forest operations.
- k. A risk assessment **should** be done to determine if additional first aid facilities are required.

### 3.15 REPORTING OF ACCIDENTS AND SIGNIFICANT INCIDENTS

All serious accidents and dangerous incidents **must** be reported to the person in charge.

Notification to Workplace Standards Tasmania **must** be carried out in accordance with the *Workplace Health and Safety Act 1995* (s.47) and the *Workplace Health and Safety Regulations 1998* rr.61-62.

### 3.16 INVESTIGATION OF INCIDENTS

All serious incidents **are to** be investigated and appropriate risk minimisation procedures are taken to prevent them happening again (*Workplace Health and Safety Regulations 1998* r.63). As part of incident investigation, it is recommended that drug testing be undertaken.

### 3.17 WORK VEHICLES

Where a vehicle is provided by an employer to transport employees, the vehicle **should**:

- a. be enclosed and have adequate seating and seat belts fitted;
- b. have adequate and safe interior lighting, heat and ventilation; and
- c. be equipped with an all-purpose fire extinguisher and first aid supplies.

A person who is engaged in a forest operation(s) **should** not carry - or cause or permit a person who is employed by that person to carry - machinery, plant, equipment, tools or appliances in a vehicle unless the items are properly and firmly secured to the vehicle, or there is an approved/suitable barrier fitted across the rear of the passenger compartment of the vehicle.

Where potentially hazardous substances or dangerous goods are transported, the container(s) **must** conform with the Material Safety Data Sheet and the requirements of the *Dangerous Goods Act 1998* and *Dangerous Goods Regulations 1998*. When these are transported in a vehicle, the following requirements **should** be considered:

- a. The items should be secured in a properly constructed compartment, vented to the exterior, separate from that used to carry passengers. Such a compartment **is to** be accessible only from outside the vehicle.
- b. The items to be firmly secured in racks installed outside the enclosed part of the vehicle in which the workers are being transported.
- c. No flammable substances are located near the source of ignition.

### 3.18 TOOLS

The employer **is to** be responsible for the safe condition of tools. The employee **must** inspect each tool to ensure its safe condition and **must** report any unsafe condition to the employer (*Workplace Health and Safety Act 1995* s.16.).

Wooden handles **should** be sound, straight-grained and tight-fitting.

Heads of shock or impact-driven and driving tools **should** be dressed or ground to remove any mushrooming. When such tools show a tendency to chip, they **must** be removed from service.

Cutting edges of tools **should** be kept sharp and properly shaped.

Tools **should** be appropriate for their use and **must** be used in a safe manner.

Before leaving the site, all visible or known spikes or other pieces of metal **must** be removed from all logs.

### 3.19 FLAMMABLE LIQUIDS AND DANGEROUS GOODS

Flammable liquids and dangerous goods must be stored, handled, conveyed and marked in accordance with the *Dangerous Goods Act 1998* and the *Dangerous Goods Regulations 1998*.

### 3.20 EXPLOSIVES AND BLASTING AGENTS

All storage, conveying, handling and use of explosives **must** be in accordance with the *Dangerous Goods Act 1998* and the *Dangerous Goods Regulations 1998*.

Any person using explosives **must** have the appropriate shot firer's permit.

When and where explosives are being used, the shot firer is responsible for the safety of the workplace.

### 3.21 FIRE EQUIPMENT FOR ROAD VEHICLES AND MACHINERY

Machinery and Road Vehicles **must** have at least one appropriately sized fire extinguisher on each motor vehicle and machine, and fire fighting equipment as determined by the Tasmanian Forest Industries Fire Prevention Committee and as amended from time to time.

Fire extinguishers **must** be fully charged and maintained in an operable condition (*Workplace Health and Safety Regulations 1998*, r.115 and AS 1851, *Maintenance of fire protection equipment*).

## 4 CHAINSAWS AND BRUSHCUTTERS

### 4.1 CHAINSAW SAFETY

All chainsaws used in forest operations **are to** conform to the requirements of AS 2726 Chainsaws – Safety requirements.

### 4.2 CHAINSAW OPERATION

All chainsaw operation **is to** be in accordance with the requirements of AS 2727 Chainsaws – Guide to safe working practices.

Information on chainsaw operational methods can be referenced from relevant chainsaw operators' manuals.

### 4.3 BRUSH CUTTERS AND CLEARING SAWS

All brush cutters **are to** be used in accordance with the Australian Standard AS 3575 Clearing saws, brush cutters and grass trimmers – Safety requirements, and also AS 3576 Clearing saws, brush cutters and grass trimmers- Guide to safe work practices.

Information on brush cutter operational methods can be referenced from relevant brush cutter operators' manuals.

Figure 2  
Recommended Starting Methods for  
Chainsaws - On Ground and Between Knees

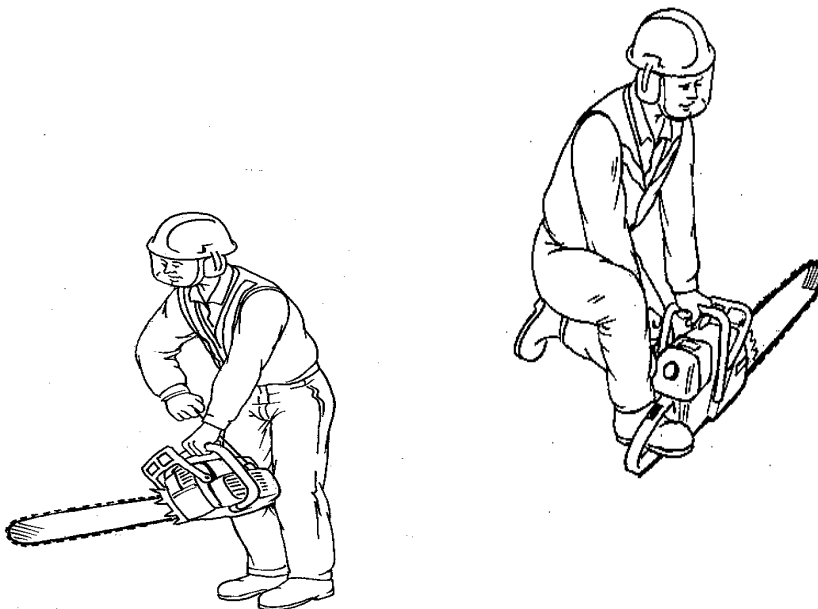

## 5 MANUAL TREE FELLING

### 5.1 GENERAL

Manual tree felling operations **should** only be carried out in daylight hours and in weather conditions that allow adequate visibility for safe felling.

The choice to fell any tree, based on a risk assessment, is the sole responsibility of the feller concerned.

### 5.2 SEPARATION DISTANCES FROM FELLERS

A distance of not less than two times the height of the tree being felled either manually or mechanically **is to** be maintained between the feller and other persons not directly involved in falling the tree.

When a trainee feller is under instruction the supervising/instructing feller may be located at the immediate base of the tree and be able to intervene in the procedure.

### 5.3 DRIVING TREES

**At no time will the practice of felling a second tree into another tree in order to bring down the first tree be undertaken.**

### 5.4 FELLER'S EQUIPMENT

The following equipment **is to** be readily available for use by tree fellers when operating a chainsaw:

- a. an axe;
- b. one lifting wedge suitable for the tree to be felled;
- c. one holding wedge suitable for the tree to be felled;
- d. two-way radio voice communication device; and
- e. one No. 15 wound dressing.

### 5.5 ACCEPTED FELLING METHODS

All manual tree-felling operations **are to** be carried out in accordance with the requirements of AS 2727 *Chainsaws – Guide to safe working practices*.

Additional information on manual tree felling techniques can be referenced from relevant chainsaw operators' manuals.

Figure 3  
Tree Felling – Positioning of Cuts

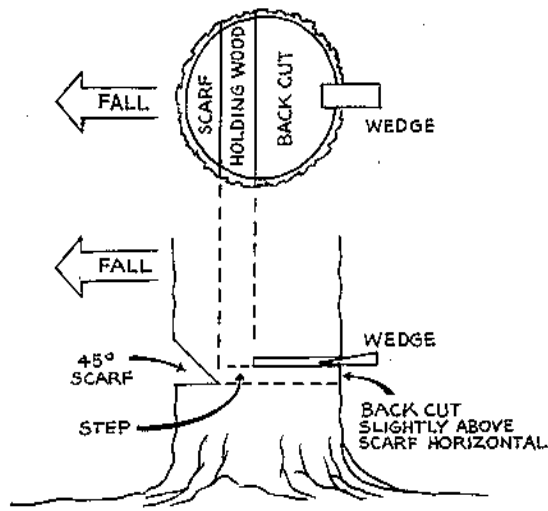

A suitable holding wedge **is to** be inserted into the back cut of each tree that is manually felled with a chainsaw (except in the case of heavy forward-leaning trees).

Figure 4  
Feller Escape Routes

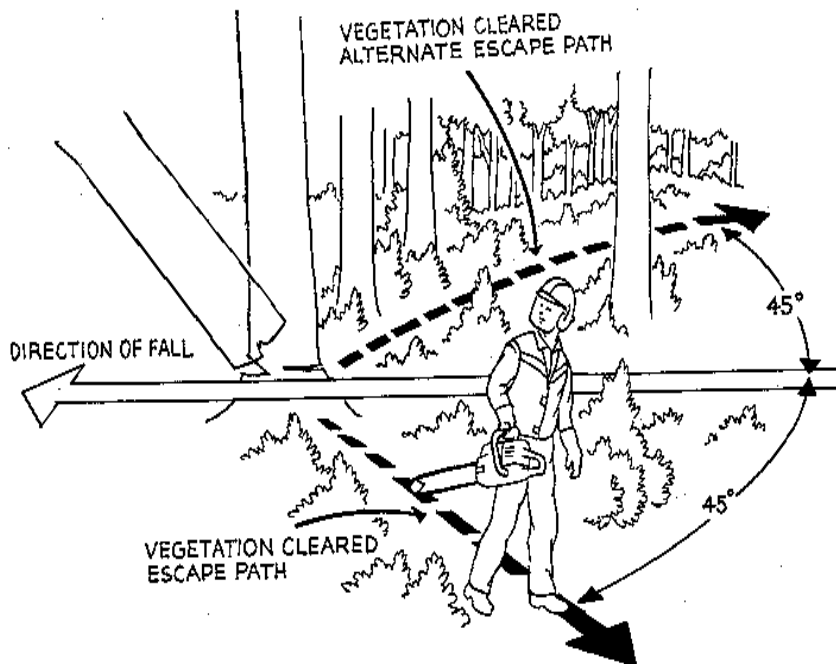



## 5.6 ESCAPE PATH

The feller is to retreat from the base of the tree at least the distance of 4 metres to minimize the risk of being struck by falling limbs.

## 5.7 THINNING

Thinning is a selective felling operation that may comprise one of the following:

- a. thinning to waste: work normally carried out in young crops to improve the stand;
- b. thinning for extraction of small piece size material for posts or pulp;
- c. thinning for saw log and small produce; or
- d. thinning for stand improvement.

### 5.7.1 Safety Procedures

The safety procedure for thinning is similar to that for felling other trees. However, the following safeguards **must** be observed by all persons engaged in this operation:

- a. Fellers **are to** keep watch on the falling tree and keep a sharp lookout for limbs and branches that may be thrown back.
- b. Fellers **are to** be aware of dead trees, or other defective trees, as these may sway forward before falling backward into the work area.
- c. Fellers **are to** fell or otherwise remove any dead or defective tree that may be positioned in the intended direction of fall before felling thinnings.
- d. Where a tree is hung up it **is to** be brought to the ground as soon as possible. The feller **should** not leave this area until the tree has been brought to the ground, other than to seek assistance.

**Before looking for help, the feller must make all other persons in the immediate area aware of the danger.**

The person in charge is to be advised when a tree cannot be completely felled so that appropriate action is taken to bring it to the ground safely.

## 5.8 DE-LIMBING

De-limbing or cross cutting **should** not be carried out from the downhill side of the log if the log has the potential to roll.

Wherever practical, standing on the log **should** be avoided when de-limbing or crosscutting.

Workers **should** approach all branches with caution, examine the branch to see if it is under tension, up or down, or bent sideways, and determine the correct method of work.

## 6 HIGHER RISK MANUAL TREE FELLING

### 6.1 COMPETENCY

Only fellers with the necessary TFITB industry accreditation and relevant experience **are to** be permitted to fell trees deemed to be higher-risk felling operations.

### 6.2 PRINCIPAL EMPLOYER OBLIGATIONS

The principal's policies **are to** ensure that operational procedures are implemented to ensure that all fellers have adequate training and competence to adequately assess and safely fell hazardous trees on coupes where contractors are engaged in timber harvesting (*Workplace Health and Safety Act 1995, s.9*).

### 6.3 MANUAL FELLING OF HAZARDOUS TREES

An accredited feller is not obliged to fell a hazardous tree that he/she considers beyond their competency to fell safely.

### 6.4 HAZARDOUS TREES

Dead or hazardous standing trees pose a higher risk of falling debris and they may fall unexpectedly. Only highly skilled personnel, using methods assessed as safe, **should** fell them.

Factors that need to be considered by the feller when identifying hazardous trees include (but are not limited to):

- a. 'widow makers';
- b. trees with exposed root systems
- c. tree's root system likely to uproot due to its location (slope, wet area, drainage);
- d. excessive rot content in the tree;
- e. tree trunk with substantial damage;
- f. storm damage to the tree;
- g. trees with burnt out sections; and
- h. dead trees;
- i. burn-out of a limb, which may cause it to fall;
- j. another tree lodged in the tree;
- k. defective tree less than two times its length away from the tree to be felled;
- l. tree with excessive lean;
- m. thick undergrowth located at the tree base which cannot be cleared;
- n. interlocking limbs;
- o. a location that restricts the feller's safe movements (boulders, logs, steep banks, road fill etc);
- p. adequacy and suitable condition of wood fibre to ensure safe directional control of the falling tree.

## 6.5 HAZARDOUS TREES – FELLING METHODS

Appropriate safe felling methods **are to** be selected by the accredited feller, in consultation with the person in charge (*Workplace Health and Safety Act 1995, s.9*).

A method other than manual felling **should** be adopted if the assessed risk is too high to safely fell the tree manually.

If this operation has to be carried out manually, work organisation **should** ensure that safety has priority.

Where it is not practicable to fell hazardous trees in advance of the felling operation, hazardous trees **are to** be brought down in progression with the felling operation.

No felling, crosscutting or de-limbing **is to** be undertaken in an area made hazardous by a leaning dead tree or a dead tree which has been brushed by a felled tree, until the tree causing the hazard has been felled.

During all operations the workplace **should** be kept as clear as possible.

Machine operators **should** be able to retreat to a safe area speedily in case of an emergency.

Hazardous trees that are a danger to any operation on the coupe are to be felled using safe systems of work.

## 6.6 HUNG-UP TREES

All trees on which felling has started **are to** be brought down safely before any further work is undertaken.

## 6.7 HUNG-UP TREES FELLING METHODS ( EXCLUDES WASTE THINNING IN PLANTATIONS)

When taking down hung-up trees, workers **should not**:

- a. fell the holding tree;
- b. climb the hung-up tree;
- c. cut lengths from the butt of the hung-up tree; or
- d. fell another tree onto the hung-up tree.

One of the following methods **should** be used to fell a hung-up tree:

- a. use a skidder or other mechanical winch to pull the hung-up tree down (when this sort of assistance is available, it is the safest option);
- b. when a skidder or other mechanical means is not available to bring down a hung-up tree, then a competent person **should** supervise the felling of that tree using a safe system of work;
- c. cut the hinge unequally so as to leave a pivot, then roll the tree using a turning hook or cable of sufficient size and strength to release the crown from the holding tree, enabling it to slide down the stem of the holding tree.

## 6.8 MARKING HAZARDOUS TREES

If a hazardous tree cannot be brought down because assistance is not available:

- a. **the hazardous area around the tree should be clearly marked with high-visibility tape to a distance of two dominant tree lengths;**
- b. **all personnel should be excluded from the hazardous area until the tree has been brought down safely.**

If it is not practicable to tape off the whole area, then clearly tape off dominant trees, natural physical features and all tracks leading to the **hazardous area**.

The high-visibility tape to be used **is to** be as follows:

- a. it **is to** have a minimum width of 75mm; and
- b. it **is to** be yellow in colour and exhibit the words 'caution' in black lettering at regular intervals along its length.

Once the hazardous tree has been felled, the high-visibility tape **is to** be retrieved immediately.

The site supervisor or person in charge controlling the harvesting operation **should** ensure that an adequate amount of tape is available.

## 6.9 TREES THAT SIT BACK DURING FELLING

Tree fellers **should** not allow a tree to sit back and compress the back cut, as this creates a dangerous situation.

Wedges **should** be used to prevent trees from sitting back.

If a tree does sit back due to unforeseen circumstances, the tree feller **should** abide by a safe system of work in accordance with the following procedures.

### 6.9.1 Procedure One

#### **Can you wedge the tree?**

- a) Take the following factors into account in assessing the tree to determine if it can be wedged and felled in the original desired direction:
  - i. tree **should** be less than 100cm in diameter;
  - ii. tree **should** not have excessive weight of foliage or branches on the back side;
  - iii. tree **should** be solid;
  - iv. wind strength and direction **should** allow forward movement of the tree in the desired direction;
  - v. Ten per cent (10%) of the diameter of the tree is retained as hingewood to allow for safe wedging.

*(Refer to page 58, Chainsaw Operators Manual, 'State Forests NSW', 1997)*

**If NO to any of the above, go to procedure number two.**

**If YES abide by the following procedure:**

- b) Insert lifting wedge(s) (aluminium preferred) in the back cut. If this is not achievable, bore a hole wide enough for the wedge(s) in or just below the compressed back cut. On small trees this bore cut may extend through the hingewood in the centre of the tree, but be sure not to cut the hingewood on the corners. This **should** be done:
- i. as near as possible to the back of the tree;
  - ii. in a position where the wood is solid;
  - iii. not in a pronounced spur which may split;
  - iv. in a position which maximises the distance between the wedge and the hingewood.
- Note:** Where two wedges are being used these **should** be spread at 45° either side of the centre of the back cut.
- c) Drive wedges until the tree leans forward and falls. If the tree leans forward but will not fall, the width of the hingewood may be reduced to 5% of the diameter of the tree.

### 6.9.2 Procedure Two

**Can the tree be felled backwards from the original intended direction of fall? The following is an example of how this may be done:**

Assess the tree to see if it is **safe** to fell the tree backwards. You will not go out in front of the tree to prepare the escape routes.

- i. A clear area will already be available.

**If NO go to procedure number three.**

- ii. Tree **should** be less than 100 cm in diameter.
- iii. There is room to fell the tree without hitting standing timber.  
(**Note:** There **is to** be a clear area, equal to the height of the tree, in the intended line of fall and in an area of 45° either side of the intended line of fall.)
- iv. The tree can be re-scarfed a minimum of 60 cm above the original back cut and then back cut without having to use the chainsaw above chest height.
- v. Ten per cent (10%) of the diameter of the tree is retained as hingewood.
- vi. There is a clear area for new escape routes on the other side of the tree.

**If NO to any of the above, go to procedure number three.**

***If YES, abide by the following procedure:***

- a. Cut a new scarf at least 60 cm above the original back cut. The higher it can be cut, the better. However, this **should not** be above chest height.
- b. Back-cut the tree using the heavy leaning tree method, i.e. bore in behind the hingewood and cut back leaving a small strap of wood at the back of the tree. Cut this strap last at 50 mm below the bore cut(s).
- c. Proceed along escape routes and pay special attention to the felling tree to ensure that the block of wood between the two lots of cuts does not pivot backwards and allow the tree to slide back over the stump.

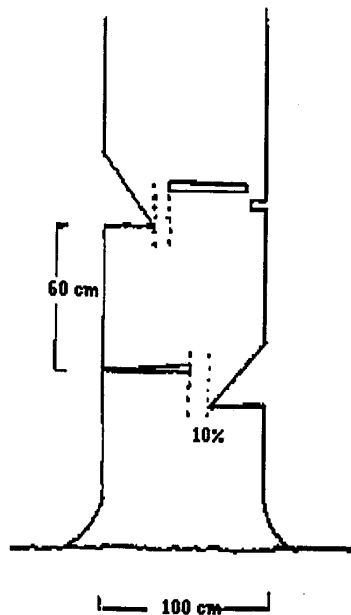

*Figure 5*  
**Example Only:**  
**Rescarfing and back cuts for saturated back tree**

### 6.9.3 Procedure Three

#### The tree cannot be felled using either Procedure One or Two.

Where a feller has determined that it is not possible to fell the tree using standard tree felling procedures one of the following procedures are to be used:

- a. leave the stump of the tree by the safest possible route, i.e.
  - i. as near as possible to 90° to the intended line of fall; and
  - ii. on the uphill side, where possible
- b. mark the exit point so re-entry can be by the same route
- c. report to the Responsible Officer/Bush Boss; and
- d. re-assess the tree to determine which is the best and safest way of bringing it down and then choose from one of the following techniques:

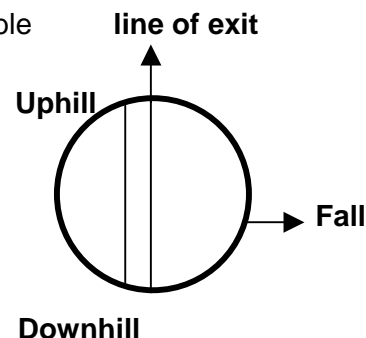

Diagram 2  
Preferred Line of Exit

#### (i) Follow techniques published in the Workplace Standards Tasmania Safety Alert No. 8 of 1997:

- tape off the area at two times the height of the tree;
- tape the sat back tree;
- tape off all entry roads and tracks;
- vacate the area and wait for the wind to bring the tree down, or have it blown with explosives.

#### (ii) Use an excavator to push the tree in the intended direction.

If this method is selected, a risk assessment incorporating, but not limited to, the following criteria **is to** be undertaken:

- **the tree will have a diameter less than 100cm diameter at breast height;**
- the excavator operator is given the right of refusal;
- the excavator is of adequate size to bring the tree down;
- the excavator is fully guarded for bush operation;
- the excavator is fitted with a log grab, fixed head, heel boom or felling head capable of controlling the tree (**Note: Use of rotating grabs is not advised**);
- the Responsible Officer/Bush Boss decides on the use, or otherwise, of an excavator;
- the feller will ensure that the tree has sufficient hingewood, 10% of the diameter of the tree, to sustain a controlled push;
- allow the excavator operator to walk in and inspect the situation before taking the excavator in;

- the excavator operator can walk straight in to the tree without having to spend time scrubbing or removing debris;
- position the excavator immediately behind the tree;
- place the attachment as high as possible on the tree, but just below full reach, so the operator can lift and push at the same time;
- push with a smooth constant action, and do not rock the tree;
- be aware of dry heads and limbs; and
- ensure that all other persons remain a minimum of two tree lengths away until the tree is brought down.

## 6.10 WIND THROW

Wind-thrown trees are those that have been brought down by strong winds. All the normal hazards are multiplied by the presence of partial or complete breaks, and by shatter and tension in trees which may be standing but weakened, leaning or fallen.

The pattern and method of work may be dictated by the direction of wind throw rather than the topography, and this adds to the difficulty and dangers.

Mechanical methods of salvaging wind-thrown trees **should** be used where practicable.

Workers **should** approach all trees with caution, and then examine the tree to see if it is under tension, up or down, or bent sideways, and determine the correct method of work.

When a tree is resting on its roots the worker **should** ensure that the cut is made in such a manner that neither he nor other workers are in danger from movement of either the stump or the log.

Bent or heavy leaning trees **should** be uprooted with a machine. Where this is not practicable, other safe systems of felling must be used.

## 6.11 BACK PULLING

It is not always possible to specify where and how a machine will be used to back-pull a tree to be felled against its natural lean. The method used will be influenced by such matters as the type of terrain, closeness to rivers, roadways and fence lines, and access for machinery. However, because of the need for extra precautions, the following general conditions **are to** apply:

- a. The operation **must** be under the direct control of a competent person.
- b. The feller and machine operator **are to** have a satisfactory means of communication.
- c. Only machines and equipment suitable to the task **are to** be used.

Where circumstances permit, the machine **is to** be operated from a distance of at least twice the length of the tree being pulled. Where this is not practicable, the method used and the placing of the machine **should** be such that there is no danger of the tree falling on or near the machine or the person involved in the operation.

The pulling rope **should** be firmly attached as high as possible on the tree and the tension applied and maintained on the rope before felling is commenced.



## 6.12 TREE JACKING

**The use of purpose-built tree jacks to move a tree away from its intended direction of fall.**

If this method is selected, the following procedure **is to** be adhered to:

- a. The person selected to use the jacks **must** be trained in tree jacking;
- b. The selected person **is to** be given the opportunity to inspect the tree before agreeing to do the job;
- c. All holes cut to insert the jack are made in solid wood;
- d. All persons not actively involved in the jacking process **are to** remain a minimum of two tree lengths away until the tree is brought down.

## 6.13 EXCAVATOR-ASSISTED MANUAL TREE FELLING

### 6.13.1 General Provisions

Excavator-assisted manual tree felling, **should** only be carried out by an operator with relevant training or experience.

### 6.13.2 Consultation

Before starting any excavator-assisted manual tree felling operation, all persons involved **must** have been consulted and informed on the operation to be carried out and have agreed on the sequence of events (*Workplace Health and Safety Act 1995 s.9*).

The consultation **must** include an assessment of the tree to be felled and surrounding trees for any visible hazards that may present an unacceptable risk. In any excavator-assisted tree felling operation the person on the ground (feller) **is to** always have control of the felling operation and have radio contact with the excavator operator (*Workplace Health and Safety Regulations 1998 r.17*).

### 6.13.3 Equipment

Any excavator used in such an operation **is to**:

Have an operator protective and falling object protective structure, suitable for forest operations (refer to section 9.6) and be equipped with a fixed log grab which:

- a. **is to** control the felling direction of the tree in a safe manner;
- b. **is to** be designed so that it can be located against the tree and ensure that the tree cannot move sideways or backwards away from the grab.

### 6.13.4 Capacity of Excavator

The excavator operator **should** ensure that the excavator has the capacity to push the tree in a safe manner.

### 6.13.5 Site Preparation

The excavator operator **is to**:

- a. clear under-storey from around the tree and create a safe footing for the manual faller to work on; and
- b. clear all hazardous trees, within two tree lengths.

### 6.13.6 The Felling Operation

- a. Where an excavator (type/ based machine) is to be used to push the tree in a direction other than its natural lean, the machine **is to** be placed in position before the tree feller approaches the tree.
- b. The log grab fitted to the dipper arm **should** be in contact with the trunk of the tree with only sufficient push force applied to prevent the tree sitting back during the felling operation.

**Note:** The attachment **should** be at a height above the ground sufficient to enable the excavator to provide an adequate force to push the tree after the felling cuts have been made.

- c. When the excavator is in position, the controls **should** be isolated to prevent any unexpected movement of the machine or attachments.
- d. Once the excavator is in position with its controls isolated the tree feller may approach and place the scarf cuts. The depth of the scarf **should** not exceed one half of the diameter of the tree.
- e. After the scarf has been removed the feller **should** place a back cut in the tree but leave sufficient even holding wood to prevent any backward movement of the tree.
- f. At no time while the back cut is being placed **should** the excavator operator apply additional force to the trunk of the tree, unless directed to do so by the feller, as this may result in the tree splitting and capping up.
- g. Once the scarf cuts and the back cut have been completed, the tree feller **is to** leave the area by the safest route to a pre-determined safe zone as determined by himself and the excavator operator.
- h. The excavator operator may then apply a steady controlled push until the tree is committed to fall.
- i. If the tree will not fall, the excavator operator **should** isolate the controls with the attachment still in contact with the tree trunk and ask the feller by radio to return to the tree and remove more hinge wood.
- j. Once the tree feller has removed additional hinge wood, the tree feller **is to** again retreat to the safe area before the excavator operator attempts to push the tree again.
- k. The feller is to ensure that the width of the hingewood is not reduced below 5% of the diameter of the tree.
- l. If the hinge wood has been progressively reduced to 5% and the tree will still not fall, the faller is to stop the operation and a person in charge **should** assess the risk of continuing.

## 6.14 DRIVING TREES

**At no time is the practice of felling a second tree into another tree in order to bring down the first tree to be undertaken.**

## 6.15 FELLING TREES WITH EXPLOSIVES (BLASTING TREES)

### 6.15.1 General Requirements

The felling of trees by explosives **must** be carried out in compliance with the *Dangerous Goods Act 1998*, *Dangerous Goods (General) Regulations 1998* and the Shot Firer Training Manual.

All blasting operations **must** be carried out in accordance with the requirements of AS 2187.2 *Australian Explosives Code - Use of explosives*.

Storage, handling and transport of explosives must be in accordance with the *Dangerous Goods (General) Regulations 1998* and AS 2187 *Australian Explosives Code 2000*.

It is the responsibility of the shot firer (who is the holder of a shot firer's licence) to ensure compliance with the above Act and Regulations.

### 6.15.2 Planning Procedures

Trees **should** be blown using the following procedures.

The tree feller and shot firer **are to** develop a site plan containing, but not limited to, the following information about the trees to be blown:

- a. the location of the trees to be blown;
- b. the natural line of fall of trees to be blown;
- c. the direction of ground slope in the work area;
- d. safe access tracks;
- e. safe escape paths; and
- f. the blowing sequence.

### 6.15.3 Site Preparation and Assessment

Before trees are felled by blasting, as far as reasonably practicable, the contractor/employer:

- a. **is to** ensure that any hazardous trees have been identified and access restricted in accordance with section 6.8;
- b. **is to** ensure that the shot firer is informed of the location of the trees to be blown;
- c. **is to** ensure that the shot firer is made aware of any hazards that have been identified that may affect his or her safety while on site, and take appropriate action to minimise any risk (*Workplace Health and Safety Act 1995* r.17);
- d. **is to** ensure that a suitable safe access track to the tree is provided;

- e. **is to** provide a licensed tree feller to carry out any chainsaw work as required by the shot firer;
- f. **is to** ensure that appropriate escape paths are in position and that an adequate work area is cleared around the base of the tree to be blown in accordance with AS 2727 *Chainsaws: Guide to safe operations*;
- g. **is to** ensure that appropriate operational fire fighting equipment is on site; and
- h. **is to** carry out an inspection after blasting to ensure that no fires have been started.

#### *6.15.4 Shot Firer's Responsibilities*

The shot firer **must** ensure that as far as is reasonably practicable, in accordance with the *Workplace Health and Safety Regulations 1998* r. 17:

- a. the explosive material is transported from the road to the tree to be felled in a safe manner;
- b. directional felling by explosives **should** be carried out so as to ensure that remaining trees are not damaged by the falling tree;
- c. blowing of tree(s) stops if weather conditions are not suitable to permit safe felling.

#### *6.15.5 Trees Containing 'Widow Makers'*

Trees identified as having 'widow makers' (broken-off limbs located in the crown of the tree) in them may present additional risks to the shot firer and tree feller while they are working at the base of the tree. Therefore the following procedures **are to** be used by the shot firer and feller:

- a. Continuous visual assessment **is to** be carried out for the possibility of the 'widow maker' falling without warning;
- b. Where possible, work is to be carried out on the other side of the tree away from the 'widow maker'.

#### *6.15.6 Blasting Sequence*

The following blowing sequence **is to** be used:

- a. First blow trees that have a natural line of fall away from other standing trees so that they fall into a clear space;
- b. Then blow trees that do not have a natural line of fall away from other standing trees.

#### *6.15.7 Blasting Groups of Trees*

When a group of trees is standing that cannot be safely blown using the above procedures then treat the group as a single tree blast, using the following procedure:

The firing sequence **is to** be designed from the first tree to any subsequent trees in such a manner that in the event of any misfire, the blasting sequence will stop.

#### *6.15.8 Unsuccessful Blast*

In the event that any tree does not fall when blasted, it **should** then be dealt with in the following manner:

- a. Assess the tree(s) to determine if it is safe to locate another explosive charge in the tree.
- b. If the assessment determines that it is not safe to approach the tree(s) or to locate another explosive charge in the tree(s), then the following **is to** be carried out:
  - i. Notify the person in charge
  - ii. Tape off in accordance with section 6.8; and
  - iii. The person in charge must carry out appropriate measures to control that risk.

#### *6.15.9 Misfired Charge*

In the event of a misfire occurring, the following **is to** be complied with:

- a. Assess the standing trees for any visible damage caused by the blasting operation (e.g. widow makers, damaged stems etc);
- b. If the remaining trees are assessed as safe to enter the area, then complete the felling (blasting) operation; and
- c. Refer to the Shotfirer Training Manual.

#### *6.15.10 Unsafe Trees Following Misfired Charges or Blasting*

If the trees are assessed as not safe to enter the area, the following **is to** be complied with:

- a. Tape off the area in accordance with section 6.8;
- b. Notify the accountable person;
- c. If an unexploded charge is present, notify Workplace Standards Tasmania;
- d. Locate **Do Not Enter** signs at appropriate areas and warning signs specifying unexploded charge present (**Danger – Misfire – No Entry**);
- e. The tree(s) are to be left standing for an acceptable length of time to permit the wind to dislodge any widow makers or bring the trees down;
- f. If the tree(s) still remains standing then it **should** be safe to carry out blasting of the standing tree(s);
- g. Only enter the blast site by the pre-planned safe entry route to the unsafe tree(s).

#### *6.15.11 Traffic Control*

Traffic control during the blasting procedures **is to** include the following:

- a. Locate correct 'Danger Blasting' warning signs in position;
- b. Lock boom gates, where they are present on access roads;
- c. Access roads which do not contain boom gates may need to be closed to traffic;
- d. Persons **are to** be positioned to prevent access to the blasting area; and
- e. All work at the site is to stop if so directed by the shot firer.

## 7 MECHANISED FELLING

### 7.1 GENERAL

Mechanised felling **is to** be planned in such a manner as to ensure the safety of other persons in the working area or who may enter the work area.

Mechanised felling **should** not create hazards for any subsequent activity.

### 7.2 DRIVING TREES

**At no time will the practice of felling a second tree into another tree in order to bring down the first tree be undertaken.**

### 7.3 MACHINE STABILITY

Mechanised felling **should** not be carried out in site conditions where the stability of the machine cannot be assured. Factors which may reduce the capacity and affect the operational stability of the machine include:

- a. machine operation on side slope;
- b. size and lean of the tree to be felled;
- c. adverse weather conditions;
- d. stability and safe bearing pressure of the ground;
- e. tracks bearing on rock; and
- f. snow cover on the trees.

### 7.4 EQUIPMENT OPERATION

The mechanised felling equipment **must** be used in accordance with the design and operational specifications provided by the manufacturer, importer, designer or supplier (*Workplace Health and Safety Act 1995* sections.9 &14).

The employer **is to** ensure that the operator is trained in the operating limits of the machine, including (*Workplace Health and Safety Act 1995* s.9):

- a. the maximum safe mass of tree;
- b. the maximum safe tree diameter;
- c. any reduced capacity when the boom is slewing;
- d. the reduced capacity of the machine at increasing side slopes;
- e. the maximum safe slope the machine may operate on;
- f. cyclic loading; and
- g. environmental factors which affect the machine's capacity.

The harvesting machine **should** be equipped with slope indicating devices.

## 7.5 FELLING DIFFICULTIES

Trees made hazardous during mechanised felling **should** be felled in accordance with section 6.15 of this code.

## 7.6 FIRE SUPPRESSION EQUIPMENT

Mechanical harvesters **should** be fitted with automatic fire suppression equipment to control the outbreak of machine fire.

## 8 FIREWOOD CUTTING

### 8.1 GENERAL

The cutting of firewood for profit or gain is a forest operation and a workplace, therefore the legislative safety requirements for this industry will be in accordance with:

- the *Workplace Health and Safety Act 1995*;
- the *Workplace Health and Safety Regulations 1998*; and
- relevant sections of this Tasmanian Forest Safety Code (Tasmania) 2007.

### 8.2 UPROOTED TREES

When a tree is resting on its roots or is under tension, the contractor, worker, employee or chainsaw operator **is to** ensure that any cut to the tree is made in such a manner that neither he nor other workers are in a position of danger from sudden uncontrolled movement of either the stump or the log.

### 8.3 DRIVING TREES

**At no time will the practice of felling a second tree into another tree in order to bring down the first tree be undertaken.**

### 8.4 TRANSPORT OF FIREWOOD

Where firewood is to be transported (not in log form), it **is to** be adequately secured to the transporting vehicle so as to ensure compliance with the *Load Restraint Guide – Guidelines and performance standards for the safe carriage of loads on road vehicles*, National Transport Commission.

### 8.5 MECHANICAL FIREWOOD SPLITTERS

All mechanised firewood splitters **are to** be guarded in accordance with the Australian Standard/New Zealand Standard 2153 – *Tractors and machinery for agriculture and forestry – Technical means for ensuring safety*.



## 9 LOG EXTRACTION

### 9.1 GENERAL PROVISIONS

Where possible, log extraction routes suitable for the extraction method and direction **are to** be planned before the forest operation to ensure that safe systems of work can be provided and maintained.

All mechanical plant and equipment **must** be operated within the specifications, capacity, instructions and information of the designer, manufacturer, importer or supplier (*Workplace Health and Safety Act 1995* ss.9-14).

### 9.2 CABLE HARVESTING

All cable harvesting operations **are to** be planned, operated and maintained in compliance with the **Tasmanian Cable Harvesting Code**.

### 9.3 LOG EXTRACTION BY MOBILE EQUIPMENT

Extraction of logs **must** not be undertaken on gradients or side slopes that exceed those specified by the equipment designer, manufacturer, importer or supplier (*Workplace Health and Safety Act 1995* s.14).

Other work **should** only be permitted if a safe distance from the snig track is maintained. This distance **should** exceed the total length of the machine plus the load unless protection is provided by standing trees.

### 9.4 WINCH CABLES AND RIGGING EQUIPMENT

Cables/wire ropes used on winches mounted on mobile equipment **are to**:

- a. be of sufficient size and strength for the proposed forest operation, and comply to the winch manufacturer's specifications;
- b. be installed, attached and spooled onto the winch drum in accordance with the manufacturer's specification; and
- c. be loaded within the limits recommended by the manufacturer.

### 9.5 CHOKER SETTING

When chokers are set or removed, the operator **is to** ensure that the log(s) will not roll.

Choker cables, chains or tongs **should** be placed securely and as close to the end of the log as is reasonably practicable.

### 9.6 FORWARDER LOADING

The loader or carrier **is to** never be loaded in excess of the manufacturer's specifications or loaded above the level of the headboard or stanchions.

When loading on sloping ground, the machine **should** be parked straight up or down the slope.

The logs being loaded in the loader **should** be fully encircled by the holding jaws when the jaws are closed.

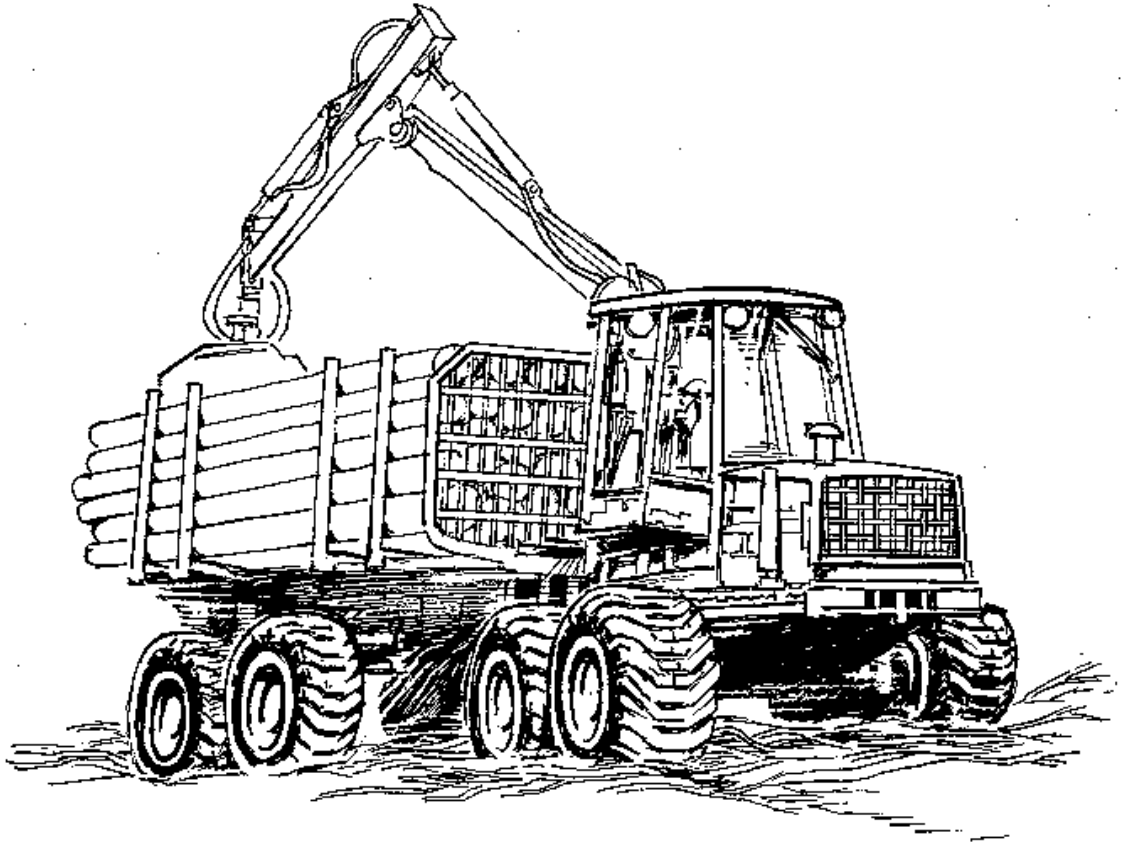

*Figure 6*  
**Safe Forwarder Loading**

## 10 MACHINERY

### 10.1 GENERAL OPERATIONS

All machinery must be used in accordance with the designer's, manufacturer's, importer's or supplier's specification, instructions and information (*Workplace Health and Safety Act 1995* sections 9 & 14).

All operators **must** wear a seat belt where fitted, when in the driving position (*Workplace Health and Safety Regulations 1998* r.58).

Any tools or equipment carried in the cabin **are to** be adequately secured and not present an additional hazard to the operator.

No persons **are to** enter the hazardous area adjacent to or beneath raised, loaded or unloaded hydraulic or cable lifting equipment.

### 10.2 GUARDING

Powered mechanical plant and equipment **is to** be guarded in accordance with AS/NZS 4024 *Safeguarding of machinery* or AS/NZS 2153 *Tractors and machinery for agriculture and forestry – Technical means for ensuring safety*.

All hot and moving parts **should** be treated as hazardous and be guarded against accidental contact, entrapment or injury, e.g.:

- a. all shafts, pulleys, flywheels, gearing, cables, sprockets, belts, chains, clutches, couplings and all blades and wings of fans;
- b. keyways, keys and grease nipples, etc. that protrude from moving parts;
- c. run-on point of any belt, chain or cable;
- d. ground wheels or tracks adjacent to the operator's position and (where provided) passenger seat;
- e. all exhaust systems or hot surfaces likely to cause burns; and
- f. all machinery used for debarking, limbing and chipping **is to** be guarded to protect personnel against flying wood chunks, chips, bark, limbs or other material.

### 10.3 MODIFICATION OF PLANT AND MACHINERY

Persons who make modifications to the original manufacturer's design to plant for use at the workplace must:

- a. ensure that the design and construction of the plant is such that persons who use the plant properly are not, in doing so, exposed to risks to their health;
- b. Ensure that adequate information is supplied about any dangers associated with the plant and about conditions necessary to ensure that persons using the plant properly are not exposed to risk to their health and safety (*Workplace Health and Safety Act 1995* s.14);

- c. Where foreseeable and reasonably practicable, identify all hazards arising, or which may arise in the workplace, and:
  - i. assess the risk associated with those hazards; and
  - ii. implement appropriate measures to control that risk (*Workplace Health and Safety Regulations 1998* rr.17-19).

## 10.4 MAINTENANCE OF PLANT AND MACHINERY

All maintenance to ensure the function and condition of plant and machinery **is to** be carried out in accordance with the designer's, manufacturer's, importer's and supplier's specifications, instruction and information (*Workplace Health and Safety Regulations 1998* regulations 83 & 85).

Machines subject to cyclic loadings may require specialised preventative maintenance procedures.

## 10.5 MACHINE ISOLATION/PARKING

The machine **should** be parked on level ground, with the transmission placed in the park position specified by the manufacturer.

When isolating the machine the operator **is to** ensure that all equipment is isolated as recommended by the designer's, manufacturer's, importer's and supplier's specifications, instructions and information.

## 10.6 MACHINE ACCESS/EGRESS

All machines **are to** be fitted with adequate access and maintained in good condition to allow the operator to enter and alight from the machine.

The operator **is to** maintain a three-point contact with the machine and face the machine when alighting from the machine.

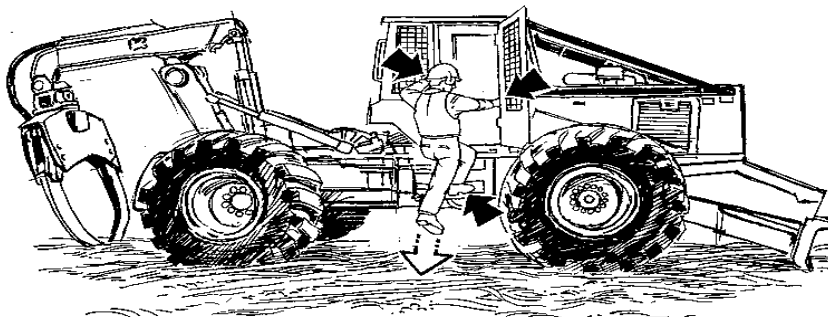

*Figure 7*

**Operator Using Three-Point Contact for Access**

## 10.7 MOBILE PLANT

### *10.7.1 Operator Protective Structures (OPS) – Mobile Mechanical Plant*

All machines used in forestry operations **are to** be fitted with a protective structure or made of such material as to reduce the risk of injury to the operator in the driving position, should the machine:

- a. overturn, roll over or tip over, and cause crushing to the cabin;
- b. be struck by a falling object; or
- c. be struck by an object which may enter the cabin.

### *10.7.2 Engineering Standards for OPS/ROPS/FOPS*

The design and manufacture of operator protective structures **are to** comply with the appropriate requirements of the relevant equipment standards of the prescribed authorities; refer below and to Table 5:

AS 2294.1 *Earth moving machinery – Protective structures*, Part 1 General

AS 2294.2 *Earth moving machinery – Protective structures*, Part 2  
Laboratory tests and performance requirements for roll-over protective structures

AS 2294.3 *Earth moving machinery – Protective structures*, Part 3  
Laboratory tests and performance requirements for falling-object protective structures

AS 2294.4 *Earth moving machinery – Protective structures*, Part 4  
Specifications for deflection-limiting volume

AS 2980 *Qualification of arc-welders for welding of steels*

AS 1554.1 *Structural steel welding – Welding of steel structures*

AS 4100 *Steel structures*

AS 1163 *Structural steel hollow sections*

ISO 8084 *Machinery for forestry - Operator protective structures*

ISO 8083 *Machinery for forestry - Falling object protective structures*

ISO 8082 *Machinery for forestry – Roll over protective structures, and*

Workplace Standards Safety Alert No. 33 *Protective canopies for excavator type machines used in forest operations.*

**Table 5 - Operator Protective Canopies Design Requirements**

| <b>EXCAVATOR BASED EQUIPMENT</b>                              | <b>Operator Protective Structure (OPS) Standard</b> | <b>Roll- Over Protective Structure (ROPS) Standard</b> | <b>Falling Object Protective Structure (FOPS) Standard</b> |
|---|---|--|--|
| Excavator Based Feller Buncher                                | WST Guide 33  | WST Guide 33   | WST Guide 33   |
| Excavator Based Tree Processor                                | WST Guide 33  | WST Guide 33   | WST Guide 33   |
| Excavator Based Tree handling                                 | WST Guide 33  | WST Guide 33   | WST Guide 33   |
| Excavator Earth Moving.                                       | WST Guide 33  | WST Guide 33   | WST Guide 33   |
| <b>PURPOSE BUILT FORESTRY EQUIPMENT</b>                       |   |  |  |
| Feller Buncher  | ISO 8084  | ISO 8082   | ISO 8083   |
| Feller Director   | ISO 8084  | ISO 8082   | ISO 8083   |
| Forwarders  | ISO 8084  | ISO 8082   | ISO 8083   |
| Skidders  | ISO 8084  | ISO 8082   | ISO 8083   |
| Processors  | ISO 8084  | ISO 8082   | ISO 8083   |
| Cable   | ISO 8084  | ISO 8082   | ISO 8083   |
| Tractor   | ISO 8084  | ISO 8082   | ISO 8083   |
| Loaders   | ISO 8084  | ISO 8082   | ISO 8083   |
| <b>WHEELED TRACTORS</b>                                       |   |  |  |
| Tractors used in forest where trees less than 3.0 metres high |   | AS 1636  |  |
| <b>EARTH MOVING MACHINERY (excluding excavators)</b>          |   |  |  |
| Graders   | N/A   | AS 2294.2  | AS 2294.3  |
| Loaders (Crawler, Wheeled and Backhoe )                       | N/A   | AS 2294.2  | AS 2294.3  |
| Crawler and Wheeled tractors                                  | N/A   | AS 2294.2  | AS 2294.3  |

Material suitable to prevent side intrusion into the cabin is to be fitted to all mobile equipment used in forest operations. If a door is fitted to the machine in question then the door must be closed while the machine is operating.

Windows requiring clear vision **are to** be protected against penetrating objects by wire mesh, steel bars or suitable polycarbonate material.

### *10.7.3 OPS Identification*

Protective structures **are to** be permanently labelled in a prominent position with:

- a. name and address of manufacturer or designer;
- b. type and serial number of OPS;
- c. make and serial number of machine attached to; and

- d. relevant standard or guide to which the structure has been manufactured.

#### 10.7.4 Damaged OPS/ROPS/FOPS

Where damage has occurred, the accountable person **must** ensure that the damaged structure is assessed by a competent person to deem whether the machine may continue to be used or requires repair or replacement before further use.

All repairs **must** be carried out by a competent person, who **is to** ensure that the repaired plant maintains its original design specification (*Workplace Health and Safety Regulations 1998 – r.85*).

### 10.8 ELECTRICAL CLEARANCE

Machinery **should** not be operated if any part of the machine comes within 15m of steel towers, or within 9m of wooden poles.

Refer to the TRANSEND Electrical Safety Code for general safety guidelines when working around live electrical transmission or distribution conductors.

### 10.9 COMMUNICATION DEVICES

Machines **should** have communication devices such as two-way radios for communication between the machine operator and other relevant personnel on site.

### 10.10 OPERATOR CONTROLS

All mobile plant controls **should** be identified and operate in accordance with ISO 10968-1995 Earth moving machinery – Operators controls.

### 10.11 EMERGENCY EXITS

Operator protective structures **are to** be built so that they always permit operators to exit from the cabin during emergency (e.g. roll over).

All mobile plant is to be fitted with a minimum of two emergency exits.

Exits **are to** be maintained in good condition to allow operator escape at all times.

Forest debris **is to** be kept cleared from the exits to allow emergency exits to open at all times.

### 10.12 WIRE ROPE

- a. No wire rope **is to** be used in any forest operations unless its breaking strength has been certified by the manufacturer or vendor.
- b. Wire rope used in forest operations **is to** comply with either:
  - i. BSD/NZS 302:Part 5: 1987 Specification for ropes for hauling purposes; or
  - ii. AS 2759 – Steel Wire Rope – Application Guide; or
  - iii. any other Standard embodying the same or more stringent criteria.

- c. Eyes in all ropes and strops **are to** be:
  - i. spliced, with ends tucked in at least three times on one side, and two on the other; or
  - ii. held by clamping devices giving at least the same strength.
- d. Wire ropes **are to** be cut with either:
  - i. a specialist non-percussion cutting tool; or
  - ii. a percussion tool using a softened hammer.
- e. Eye-to-eye splices **are not to** be used in:
  - i. load-bearing or working ropes; and
  - ii. strops used for lifting purposes.
- f. Wire rope **is to** be replaced if it shows signs of:
  - i. excessive wear (10%);
  - ii. corrosion;
  - iii. kinking;
  - iv. stranded wires; or
  - v. being burned.
- g. Knots **should** not be used in any wire rope.
- h. 'C' hooks **should** not be used in any logging operation.
- i. White metal babbiting **is to** be performed in accordance with AS 2759 Steel wire rope – Application guide.



## 11 LOG LANDINGS

### 11.1 PLANNING

The log landing is the focus of a forest harvesting operation and **should** be planned and constructed for the safe and efficient handling of logs.

### 11.2 LANDING LAYOUT

The landing area **is to**:

- a. be large enough to enable activities carried out on it to be safe and with as little intrusion as possible between each task;
- b. permit the safe passage of other traffic which may need to pass the operation;
- c. be large enough to allow the safe storage of logs; and
- d. be cleared of all hazardous trees for a distance of one standing tree length from the processing area.

### 11.3 LOCATION

A log loading area **should**, where reasonably practicable:

- a. be positioned in the flattest area and be located where the slope of the ground is not more than eight degrees;
- b. be kept clear of all hazardous debris;
- c. have a safe pedestrian access and visitor control procedures; and
- d. be located so as to allow safe site rehabilitation after the forest operation.

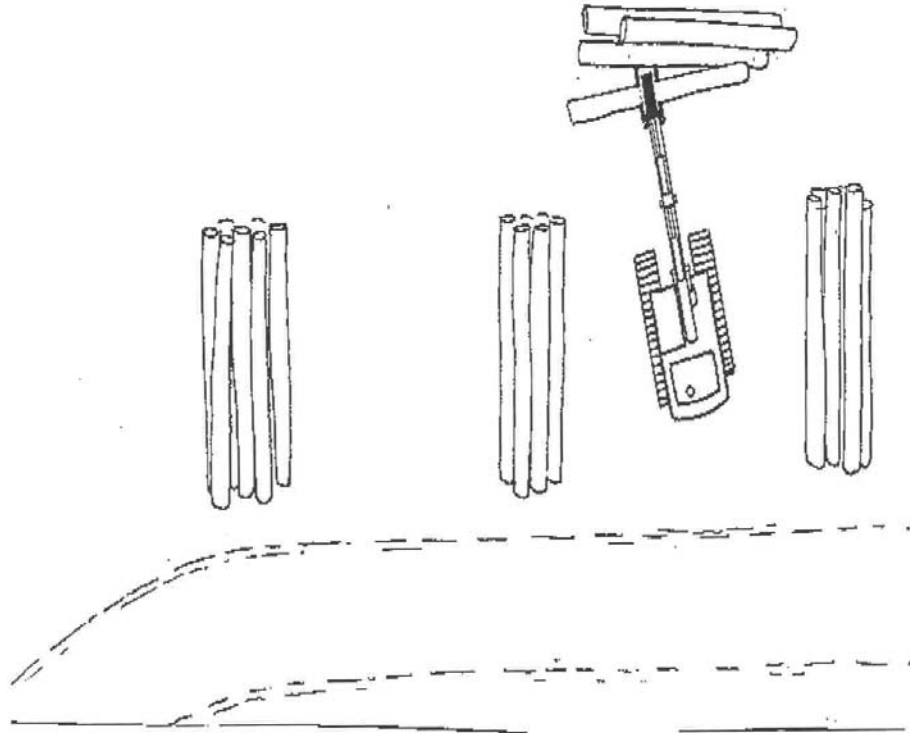
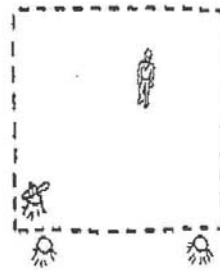
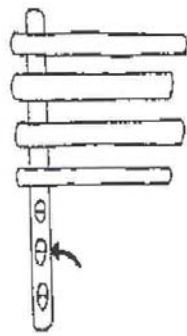

Diagram 3  
Safe Landing Layout

## 11.4 OPERATING PROCEDURES

The accountable person **must** ensure that safe systems of work are implemented to ensure that (*Workplace Health and Safety Act 1995* s.9):

- a. The skidding machine **is not to** enter the landing area until it is safe to do so.
- b. Logs **should** be approached only after they have been completely landed and, if necessary, stabilised.
- c. A machine operator **is not to** carry logs over ground crew.
- d. Workers **are not to** be exposed to hazards from moving logs by working in front of, climbing onto or working on logs placed in log stacks or dumps.
- e. A chainsaw **is not to** be used to cut logs on a log truck.

## 11.5 LOG STACKS

Logs **should** be stacked on firm, level ground or a sound base.

Log stacks **should** be made and maintained in a stable condition.

Logs stacks **should** not exceed safe working height that can be handled by log handling equipment.

## 11.6 LOG MEASUREMENT

When measuring any log on the landing, persons **should** abide by the following safe systems of work:

- a. assess all risks to personnel and equipment before commencing any measuring operation;
- b. locate the log in a designated area away from any other working operation;
- c. position the log in a safe manner for measuring, (e.g. on a notched log);
- d. inspect the log to ensure that it is adequately chocked to prevent it rolling or sliding;
- e. place the tape around the centre of the log and do not position yourself under the log at any time;
- f. measure the length of the log, by hooking the tape on lower end of log and reading from the raised end; and
- g. brand the raised end of the log, ensuring that there is sufficient space to swing the hammer.

## 12 TRANSPORTATION

### 12.1 TRANSPORTATION GENERAL

Employers, contractors or employees of load-carrying vehicles operated in the transportation of goods, materials, machinery and equipment used in the forest industry or services to the forest industry **are to** ensure that maintenance, safe loading and operation are conducted in accordance with the requirements of the *National Load Restraint Guide – Guidelines and performance standards for the safe carriage of loads on road vehicles, National Transport Commission*.

All loads **should** be constructed and secured to the transporting vehicle in such a manner as to ensure compliance with the *National Load Restraint Guide*.

#### *12.1.1 Bush Operations – Approach to Landing*

Trucks **should** not approach a landing when there is danger from incoming produce.

#### *12.1.2 Moving Vehicles*

Workers **must** always keep a safe distance from moving and loading vehicles.

#### *12.1.3 Vehicle Operations – Maximum Loads*

There **must** be adherence to state traffic legislation maximum load requirements.

#### *12.1.4 Correct Operation of Vehicles*

Drivers **must**:

- a. hold the legally required licence appropriate for the class of vehicle they are operating;
- b. observe traffic regulations at all times;
- c. have a thorough knowledge of the regulations and instructions for operating the particular class of vehicle they are driving; and
- d. have the final responsibility to ensure that the truck is loaded correctly and securely (*Guidelines and performance standards for the safe carriage of loads on road vehicles, National Transport Commission*).

#### *12.1.5 Riding on Loads*

The driver **is to** ensure that no person is permitted to ride on any part of a log transport vehicle other than in the cab.

#### *12.1.6 Equipment to be Fitted to Trucks*

All log trucks and trailers used for the transport of logs from the forest to the destination of the forest produce **are to** be of appropriate design and construction for the safe transport of forest produce.

#### *12.1.7 Suitable Communication Equipment*

Trucks **should** be equipped with suitable communication equipment.

## 12.2 CAB SHIELDING (GUARD)

All trucks transporting logs **are to** be fitted with a cabin guard to protect the driver or passenger from the impact of a partial load from the rear loaded logs.

### *12.2.1 Physical requirements*

The cabin guard **should**:

- a. be capable of restraining a load of 4000N applied horizontally at any point on the structure and distributed over the area of a 400mm diameter circle;
- b. be able to withstand wind forces generated when the vehicle is travelling at 100Km/h;
- c. be higher than the driver's cabin;
- d. cover a cross sectional area of the maximum load carried on the log trailer assembly;
- e. be capable of restraining logs with a minimum diameter of 110mm; and
- f. be free from any protrusions that may penetrate the cabin if the guard fails and moves forward into contact with the rear of the driver's cabin.

Refer to Diagram 4.

### *12.2.2 Operational requirements*

The guard under normal operations **should** be:

- a. mounted so that vibration generated by the transport vehicle cannot distort or damage the structure of the guard;
- b. constructed free of any sharp corners or edges which can result in injury to operators;
- c. capable of withstanding inertia forces generated during vehicle braking;
- d. securely fixed to the vehicle in the case of cabin and guard failure due to bending; and
- e. where practicable, fitted so that the guard is able to slew with the load, so that logs are prevented from moving past the cabin when the transport vehicle is driving through a sharp curve.

### *12.2.3 Design and construction*

All design, manufacture and construction of the cab (shield) guard, **must** be undertaken by a competent person.

*Diagram 4*  
**Typical Cab Shielding Guard**

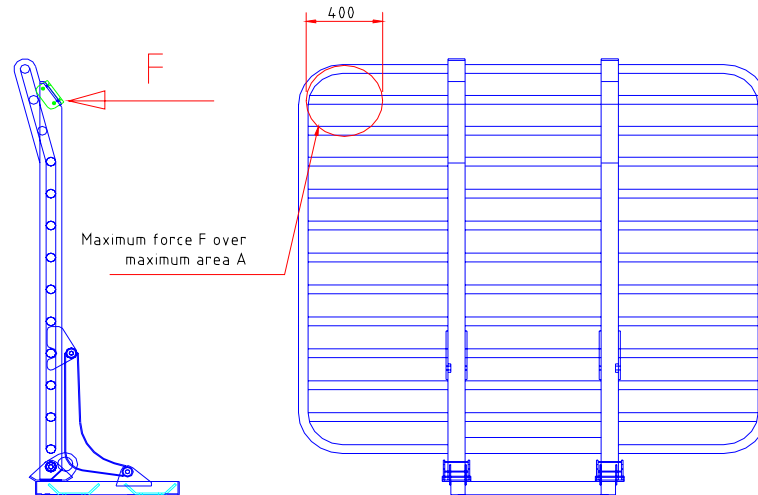

Steel structures **should** comply with the requirements of AS 4100 Steel Structures and have a strength of at least 350 N/mm<sup>2</sup>.

Alternative materials may include cast iron, cast steel, aluminium or equivalent composite materials.

## 12.3 REAR LOAD RESTRAINING GUARDS

Rear load restraining guards (to prevent the release of logs from the rear of the load) **must** be fitted to log trucks where the rear bunk on the load is carrying debarked eucalypt tree farm logs in short form. Where reasonably practical rear load restraining devices should be fitted to loads carrying debarked long length eucalypt tree farm logs.

### *12.3.1 Physical requirements*

The rear guard should be:

- capable of restraining a load of 500N applied horizontally at any point on the structure and distributed over the area of a 400mm diameter circle;
- able to withstand wind forces generated when the vehicle is traveling at 100km/h;
- high enough to restrain all the logs; and
- capable of restraining logs with a minimum diameter of 110mm.

### *12.3.2 Operational requirements*

Under normal operations the guard **should**:

- be mounted in such a manner that vibration generated by the transport vehicle cannot distort or damage the structure of the guard;
- be constructed free of any sharp corners or edges which can result in injury to operators; and

- c. be capable of withstanding inertia forces generated during vehicle braking.

### *12.3.3 Design and construction*

All design, manufacture and construction of the cab (shield) guard **must** be undertaken by a competent person.

Steel structures should comply with the requirements of AS 4100 Steel Structures and have strength of at least 350 N/mm<sup>2</sup>.

Alternative materials may include cast iron, cast steel, aluminium or equivalent composite materials.

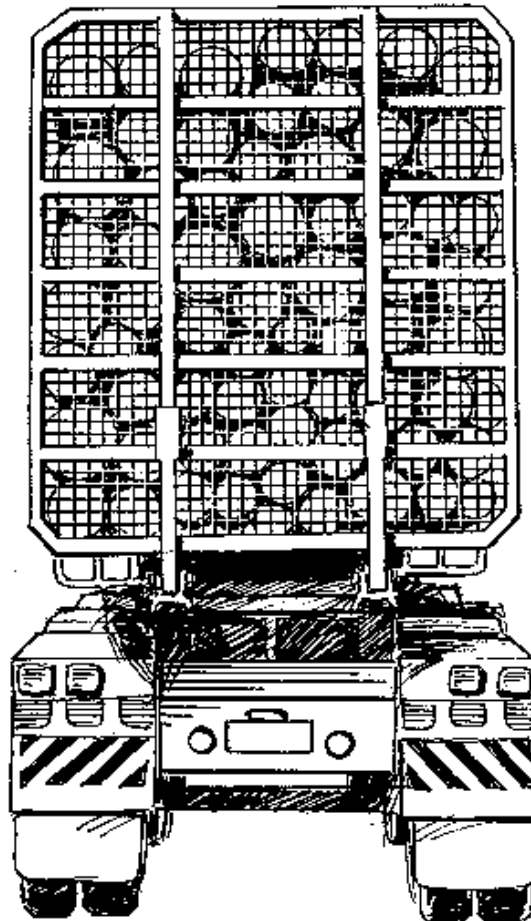

*Figure 8*  
**Rear Guard**

## 12.4 SELF-LOADING TRUCKS

Self-loading trucks **are to** be fitted with outriggers and stabilisers that firmly stabilise the unit while loading and unloading.

Outriggers and stabilisers are to be fitted in accordance with AS 1418.5 Mobile and vehicle loading cranes.

All practical steps **are to** be undertaken to protect the driver of a self-loading truck from log movements when he is operating the log-loading device. A positive means is to be provided to prevent a free fall of the boom in the event of malfunction. A safe means of access to the log loading position is to be provided.

## 12.5 LOADING OF LOGS

On arrival at the workplace, communication between the truck driver and loader operator **should** be established.

During loading operations the loader operator **is to** ensure that the area in the immediate vicinity of the operation is clear of all persons.

The log truck driver and any other person **is to** be no closer than four (4) metres to the front or ten (10) metres to the rear of the vehicle being loaded and **should** maintain visual contact with the loader operator or machine throughout the loading operation except:

- a. during periodic checking of scales, load construction, lay of logs, and the securing of the load by the driver, the loader operator **is to** ensure that the loader remains stationary; or
- b. where it is necessary for the driver to manoeuvre the vehicle during loading operation, e.g. heelboom loaders.

In multi-bunk configurations, the truck driver must not be in the cabin during loading of the front bunk. Once the front bunk has been secured the driver may return to the cabin for the remainder of the loading.

The front bunk will be secured before moving the truck to complete loading.

The method of loading the log(s) **is to** ensure that the log(s) is/are secure at all times.

## 12.6 LOAD REQUIREMENTS

### 12.6.1 Load Configuration

The driver **must** ensure that the load is constructed so that:

- a. it meets the requirements of the National Transport Commission Guidelines and performance standards for the safe carriage of loads on road vehicles;
- b. where the load projects beyond the rear of the vehicle, a suitable reflective device **should** be attached;



- c. no more than 50% of the end diameter of any log **is to** be above the top of the cab shield (guard) of the log truck;
- d. outside logs that are in contact with the stanchion must have no part of that log above the height of the stanchion;
- e. all loads **must** be crowned to ensure load security. The load should be secured within a reasonable distance of the landing and prior to leaving the coupe;
- f. logs used to crown a load **must** have no part of the log more than 50% above the height of the stanchion; and
- g. outer ends of the outside logs **should** extend 300mm beyond stanchions.

### *12.6.2 Load Securing*

The driver **is to** ensure that:

- a. load must be secured to the vehicle in accordance with the National Transport Commission Guidelines within a reasonable distance of the landing and prior to leaving the coupe
- b. both ends of all binders are located in the appropriate tensioning device before the tensioning of any one binder is carried out;
- c. every bunk is restrained by at least two binders and every load is restrained by at least three binders on each load;
- d. every log is restrained by a **minimum** of two load binders on each log, either directly by contact with the binder, or indirectly, if bound by surrounding logs; and
- e. where practical a rear restraint device **should** be fitted to prevent logs sliding from the back of the load.

### *12.6.3 Load Release and Unloading (non sawmill sites)*

Unless using a de-twitching station, before load binders are released the loader operator **is to** ensure that the load is adequately restrained to prevent any unexpected movement of the logs.

Any person, including a truck driver, working adjacent to a truck log unloading operation **is to** place themselves at the front or at the rear of the vehicle and to either side and not closer than four (4) metres to the front or ten (10) metres to the rear of the vehicle in order to maintain eye contact with the loader operator or machine throughout the unloading operation.

Where a machine other than a winch is used to unload a vehicle, the binders are to be released from the unloading side, with the central binder removed first, followed by the rear binder and finally the front binder.

Where a winch is used to unload a vehicle, the binders are released from the opposite side of the vehicle to the unloading side, with the rearmost set of binders being removed first, then the next set until the foremost set is removed last.

The driver of a vehicle **should** not use a winch for unloading logs from the vehicle except when accompanied by another person.

#### *12.6.4 Securing Jinker or Trailer*

Where the driver of a vehicle returns with an empty vehicle with the jinker or trailer loaded on the vehicle in piggyback style, the driver **is to** ensure that:

- a. the jinker or trailer is secured to the prime-mover or the forward trailer by a latching mechanism or a chain and load binder;
- b. a safety chain or tensioned secondary latch is used between the jinker or trailer and the prime-mover or forward trailer; and
- c. all chains used to secure the jinker **are to** be in accordance with the manufacturers recommendations.

### 12.7 LOG RESTRAINING EQUIPMENT

The owner of a vehicle that is used for transporting forest produce **must** provide and maintain log restraint equipment in good working order (*Workplace Health and Safety Regulations 1998 r.85*).

#### *12.7.1 Bolsters*

A bolster **is to** :

- a. be of adequate size and strength to secure/support the load; and
- b. be securely attached to the chassis members.

#### *12.7.2 Chocks*

A chock **is to**:

- a. have a base of not less than 450 mm in length; and
- b. be fastened to the bolster with not less than two chock pins, each of which is to be not less than 22 mm in diameter and drilled with a hole through which a retaining clip **is to** be placed.

#### *12.7.3 Stanchions*

A stanchion **should** be securely attached and be of sufficient height to ensure that outside logs have their diameter below the top of the stanchion.

#### *12.7.4 Stanchion Extensions*

Where stanchion extensions are used they **should**:

- a. be of adequate size and strength;
- b. be securely fastened to the bolster.

### 12.8 LOAD INSPECTION

Log truck drivers **are to** be responsible for ensuring that:

- a. loads are inspected and are safe before leaving the log landing;
- b. loose bark **is to** be identified and a safe method of bark removal adopted;
- c. adjustment to log configuration **is** undertaken by log handling equipment;

- d. no person climbs onto the loaded logs on a truck;
- e. log trucks display the appropriate rear warning device on the load where applicable;
- f. they inspect the load immediately before the truck enters the public road system, so as to ensure log stability and load safety;
- g. load and truck visual inspections are to be a full visual walk around the entire vehicle; and
- h. the load remains secure at all times throughout the journey.

## 12.9 LOADING/UNLOADING OF RAIL WAGONS

When log securing devices **are to** be released on rail wagons at the point of 'off loading', to secure the load:

- a. before releasing log securing devices, all wagons **are to** be inspected from a position that allows observation of each wagon and the stability of all top logs;
- b. until the wagon is in the unloading position, no portion of the load **is to** be released if any portion of the load is above the stanchions.
- c. log securing devices **should** not be released when any part of a log is located above the top of any stanchion unless the load is adequately restrained.

## 13 ROAD CONSTRUCTION AND MAINTENANCE

### 13.1 CONSTRUCTION

#### *13.1.1 General Provisions*

All machines and equipment used in quarrying, construction and maintenance of roads and bridges **must** conform with the designer's, manufacturer's, importer's or supplier's specifications, instructions and information (*Workplace Health and Safety Act 1995 s.14*) and comply with all state and national road transport regulations.

#### *13.1.2 Planning*

Issues that **should** be considered during road planning include, but are not limited to:

- a. road intersections, sight distances, speed of road traffic;
- b. passing bays during construction;
- c. road design – alignment, gradients and pavement widths;
- d. evacuation routes and procedures in case of emergencies;
- e. the type of transport being used for personnel, materials and produce;
- f. evaluation of the environmental factors that may impact on safety; and
- g. both natural and man-made hazards, e.g.
  - i. topography;
  - ii. standing hazardous trees.

#### *13.1.3 Construction*

All construction work **must** be undertaken so as to comply with legislation relevant to the work being undertaken and the location of the road.

All signs and safety devices **must** comply with the *Traffic Control at Work Sites Code of Practice*.

All signs and safety devices **are to** comply with AS 1742 *Manual of uniform traffic control devices*, **should** be in place before work starts and **should** provide adequate warning of work in progress.

Road lines **should** be logged before road construction.

Where road lines are not harvested before road construction, all trees pushed or felled **should** be pulled/pushed clear of standing trees and left in a safe position.

Road clearing **is to** include the removal of hazardous trees that may fall onto the road surface.

All construction operations **must** be carried out using safe systems of work and allow all road users and adjoining landowners to pass safely through or around the road works (*Workplace Health and Safety Act 1995 s.9*).

Approaches to dips in the road alignment, bridges and culverts **should** contain gradual rather than sudden grade changes.

Pavement design and construction **should** be adequate to allow the safe passage of all vehicles that may use the road. Refer to Forest Practices Code.

While gravel trucks are tipping loads, all personnel in the vicinity must be in a safe position.

#### *13.1.4 Road Maintenance*

Unsealed road surfaces exposed to rain and traffic can deteriorate and impact on the safety of the road user. Maintenance **should** be carried out when necessary to ensure a reasonable quality of road surface and control the risk to vehicles and users (*Workplace Health and Safety Regulations 1998 r.17*).

#### *13.1.5 Warning Signs*

**During road maintenance** all traffic control devices for warning, guiding and protecting the road user **should** be used.

All signs and safety devices **must** comply with the *Traffic Control at Work Sites Code of Practice*.

Road signs **should** comply with sections 1.5 and 1.6 of the *Traffic Control at Work Sites Code of Practice* and AS 1742.3 – 1996 *Manual of uniform traffic control devices, Part 3: Traffic control devices for works on roads*.

Immediately the work is finished, all temporary signs and safety devices **should** be removed from the site.

## 13.2 QUARRIES

Quarries **should** be developed in accordance with the Australian Standard 3574 Quarry Code of Practice.

#### *13.2.1 Equipment Protective Structures*

In any quarrying operation, mobile plant **is to** be fitted with protective structures in accordance with AS 2294 – *Earth moving machinery – Protective structures*.

#### *13.2.2 Clearing of Vegetation*

A risk assessment must be carried out to determine how far back trees must be cleared from a quarry face.

#### *13.2.3 Warning Signs*

Appropriate warning signs complying with section 3.12 of this code **must** be in place to ensure that anyone approaching the area is aware of the operation.

### 13.2.4 Blasting

A person conducting blasting operations **must** hold an appropriate current shot firer's permit (*Dangerous Goods Act 1998*).

The shot firer **must**:

- a. carry out all blasting in accordance with the requirements of AS 2187.2 *Use of explosives*.

### 13.2.5 Explosives

Storage, handling and transport of explosives **must** be in accordance with the *Dangerous Goods (General) Regulations 1998* and *Australian Explosives Code 2000*.

Construction of magazine **must** comply with the requirements of AS 2187.1 *Storage and transport*.

### 13.2.6 Benching

All quarry benching **is to** be carried out in accordance with the *Quarry Code of Practice June 1999*.

Quarrying on steep slopes is best carried out in a series of working benches.

Low face heights between benches are safer. Face heights between benches **should** not exceed 12 metres. A lower face height may be appropriate, depending on geological stability of rock/earth face.

There **should** be safe access onto quarry benches, the edges of which **should** be kept clear of debris.

## 13.3 BRIDGES

### 13.3.1 General Provisions

- a. Equipment used **should** be of adequate capacity to handle materials used in bridge work.
- b. All persons **should** be clear of the 'slew area' of materials handling equipment and overhead movement of materials.
- c. No person **is to** be suspended from any equipment unless in an approved 'personnel cage'.
- d. Bridges **must** be adequate to carry intended loads.
- e. A safe working area **should** be provided to process material used in bridge construction.
- f. Flotation devices **should** be worn when working over water.
- g. Any prefabricated scaffolding used during bridge construction or maintenance **must** be of an approved type (*Workplace Health and Safety Regulations 1998 r.102*).

## 14 SILVICULTURE

### 14.1 CHEMICAL SAFETY

#### *14.1.1 Hazardous Substances*

The employer **must** have a hazardous substances register for all hazardous substances used at the workplace (*Workplace Health and Safety Regulations 1998 r.77*).

This register **must** include:

- a. the product name of the substance;
- b. the substance Material Safety Data Sheet (MSDS); and
- c. the quantity of the hazardous substance at the workplace.

#### *14.1.2 Storage of Hazardous Substances*

The employer **must** refer to the MSDS for information concerning storage requirements and for hazardous substances stored in the workplace.

#### *14.1.3 Material Safety Data Sheets (MSDS)*

Employers **must** keep their employees informed about the hazardous substances in their workplace (*Workplace Health and Safety Act 1995 s. 9*).

#### *14.1.4 Precautions to be Taken before Commencing Work*

Before working with hazardous substances, employers and employees **must** be informed and understand (*Workplace Health and Safety Act 1995 s.9*):

- a. the contents of the MSDS in the approved format;
- b. the safe use of the product as defined in the MSDS;
- c. usage arrangements, e.g. site control, training, storage, use of personal protective clothing and equipment;
- d. the requirements for the protection of the health and safety of all employees and visitors and the public not directly working with the hazardous substances; and
- e. the conditions of the *Code of Practice for Ground Spraying* and the *Code of Practice for Aerial Spraying* when using agricultural chemicals.

### 14.2 SEED COLLECTION

#### *14.2.1 General Provisions*

All seed collectors **must** be inducted into safe work practices to be observed at the workplace (*Workplace Health and Safety Act 1995 s.9*).

### *14.2.2 Defined Seed Collecting Work Areas*

Before starting seed collection, the seed collectors' work area **should** be defined so that it is a safe distance away from any other forest operation.

### *14.2.3 Co-joined Operations*

Where seed collecting is to be carried out in conjunction with any other forest operation, the person in charge of the seed collecting **is to**:

- a. liaise with the person in charge of the other forest operation;
- b. carry out a hazard identification and risk assessment of any potential danger from the co-joined operation before starting activities;
- c. implement controls to ensure the safety and minimise the risk of all operators;
- d. comply with any existing forest operation safety plan on adjoining forest operations where hazards may impact on the seed collecting operation; and
- e. obey all instructions given by the person in charge of the other forest operation.

### *14.2.4 Isolated Work*

Refer to section 3.4 of this code.

### *14.2.5 General Precautions*

All personnel engaged in seed collection **are to**:

- a. maintain a distance of two dominant tree lengths from fellers and the working extremes of cable logging hauling lines;
- b. work upslope of felling, log hauling or log loading operations;
- c. use machetes fitted with a lanyard which can be attached to the wrist of the user;
- d. ensure that they are familiar with all the requirements for that coupe as specified in the Forest Practices Plan and as defined in the Forest Practices Code; they **should** also ensure that they do not compromise any detailed requirements of those documents; and
- e. ensure that they are aware of the Forest Operations Safety Plan and any hazard control requirements implemented by the person in charge of the seed collection.

### *14.2.6 Firearm Use*

Use of firearms for the dislodgment of seeds **must** be strictly controlled and comply with the *Firearms Act 1996*.

Ensure that adequate controls and safe working distance are maintained when firearms are being used at the workplace.



## 14.3 TREE PRUNING

### *14.3.1 Safety Equipment*

- a. Climbing helmets complying with DIN7948/EN 12492 (or a similar standard as amended from time to time) are a suitable alternative to helmets complying with AS 1801 Occupational protective helmets, for tree pruning operations.
- b. A suitable system for working at heights **must** be used when pruning at an elevation greater than two metres.
  - i. The system for working at heights **must** meet Australian (or equivalent) Standard.
  - ii. The operator **must** attach the system for working at heights to the tree as soon as is practical and not remove the device until pruning of the tree is completed.
  - iii. All safety equipment **must** be maintained and in good condition.

### *14.3.2 Ladders*

- a. Ladders **must** comply and be used in accordance with AS/NZ 1892 Portable ladders (Workplace Health and Safety Regulations 1998 r.94).
- b. Ladders **must** be regularly checked and have defects repaired before use.
- c. Particular attention **should** be given to:
  - i. junction of stiles and rungs;
  - ii. interlocking joints; and
  - iii. chains and pins in metal ladders and accessories.

### *14.3.3 Pruning Shears*

Pruning shears **should** be kept in good working condition.

### *14.3.4 Pruning Saws*

- a. The pruning saw **should** be kept in its pouch when climbing or descending a ladder.
- b. Where practicable, the free hand **should** always be above the branch being cut.
- c. The saw blade **should** be properly tensioned.
- d. Tools **should** not be thrown to the ground.

### *14.3.5 Pole Pruning*

- a. Where pole pruning is undertaken, safety helmets with a suitable chin strap **must** be worn.
- b. Workers **are to** be at least one and a half pole lengths apart while working.
- c. Eye protection **must** be worn.

### *14.3.6 Ultra-High Pruning*

Guidelines for tree climbing are contained in section 14.4.

### 14.3.7 Mechanical Pruning

Where mechanical or gas-operated pruning equipment is used, the operator **must** comply with the safety specifications, information or instructions as recommended by the designer, manufacturer, importer or supplier (*Workplace Health and Safety Act 1998* s.14).

### 14.3.8 Chainsaw Pruning

- a. All chainsaws used in pruning operations **are to** comply with AS 2726:2 Chainsaws for tree service.
- b. When a chainsaw is used for pruning, it **should** be fitted with a chain guard that will prevent injury from kickback.
- c. A safety belt **is to** be used when medium and high pruning with a chainsaw.

## 14.4 TREE CLIMBING

### 14.4.1 Safety Belts and Harnesses

- a. Safety belts or harnesses **must** be worn when working above two metres in height.
- b. Safety belts and harnesses for silviculture and seed collection **must** comply with either:
  - i. AS/NZS 1891.1:1995 Industrial fall arrest systems and devices, Part 1 Safety belts and harnesses; or
  - ii. AS 2759 Steel wire rope – Application guide; or
- c. Safety belts and harnesses for tree climbing logging **are to** comply with either:
  - i. ASTM F 887 – 91a Personal climbing equipment;
  - ii. Tasmanian Cable Logging Code; or
  - iii. any other Standard embodying the equivalent or more stringent criteria.

### 14.4.2 Power Operated Work Platforms

- a. A power operated elevating work platform **must** have a current design registration number and Registered Plant Inspector's certificate (*Workplace Health and Safety Regulations 1998* Reg 96).
- b. The power operated platform **must** be capable of safely operating when:
  - i. elevating, and lowering and positioning;
  - ii. slewing and transporting (where applicable);
  - iii. lifting its designated safe working load (SWL).
- c. The elevating work platform **must** be operated in accordance with the safety specifications, information or instructions as recommended by the designer, manufacturer, importer and the requirements of AS 1418.10 Elevating Work Platforms and AS 2550.10 Elevating Work Platforms.

## 14.5 ELECTRICAL SAFETY

### 14.5.1 Clearance Distances

You don't have to come into direct contact with a power line to be killed. Even close proximity can be fatal. You may be hauling logs, felling trees or driving machinery with high loads so make sure there is plenty of clearance. Appearances can be deceptive, especially on steeper slopes. The lines may be closer than you think.

The sag and sway of powerline conductors can vary greatly during the day depending on:

- a. day temperature;
- b. span length;
- c. conductor temperature;
- d. distribution powerline conductor material;
- e. distribution powerline conductor tension; and
- f. wind velocity.

These factors **are to** be considered when assessing the risk of the operation.

A minimum safe work distance of two (2) meters away from the distribution powerlines **must** be maintained.

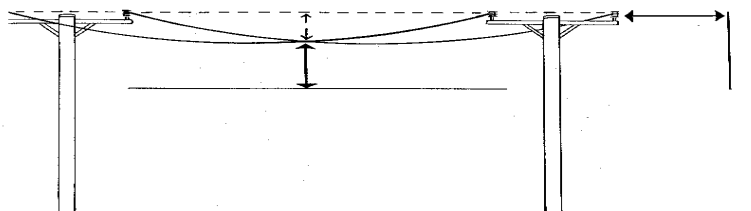
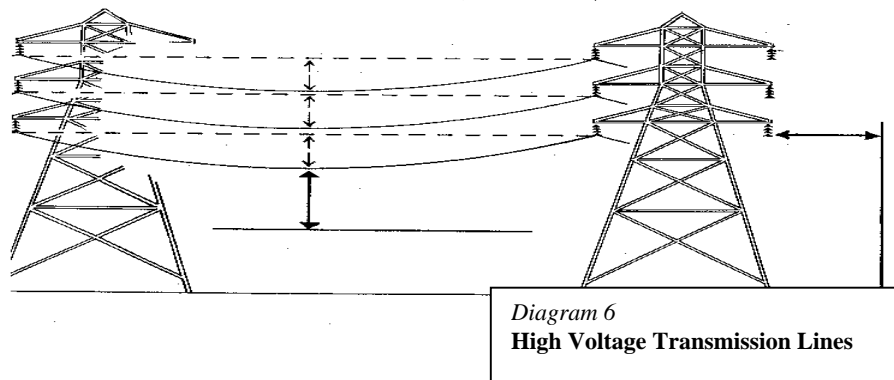

*Diagram 5*  
**Horizontal  
and Vertical  
clearance  
from  
energised  
distribution  
powerlines**

Isolation of equipment is required and Permit To Work conditions may apply. Contact your AURORA ENERGY office on telephone number 1300 132 045 for further information.

A minimum safe working distance of six metres, forty centimeters (6.4m) away from the transmission powerlines **must** be maintained.

**Note: Some transmission lines are located on poles.**



Isolation of equipment may be required and Permit To Work conditions may apply. Contact your TRANSEND NETWORKS office on telephone number 1300 361 811 for further information.

## 14.6 WIND ROWING

The contractor and the machine operator **are to** consider potential hazards when undertaking the site assessment including:

- a. dangerous trees still standing either within or adjacent to the clearing operation;
- b. side slope and the capacity of the mobile plant that will operate on the site;
- c. mine shafts, wells or sink holes;
- d. electrical or reticulated gas pipelines;
- e. unstable sites; and
- f. stability of windrow materials.

### *14.6.1 Multiple Machine/Personnel Operations*

Where more than one machine is working on a slope or with personnel present on the site the operator **is to** avoid operating directly above other operations or persons where there is a possibility that stumps, rocks or logs may roll or slide down the slope.

### *14.6.2 Windrow Formation*

When windrowing large logs, stumps or rocks, the operator **is to** place them at the base of the windrow, and other smaller material **should** be placed around them to increase the windrow material stability.

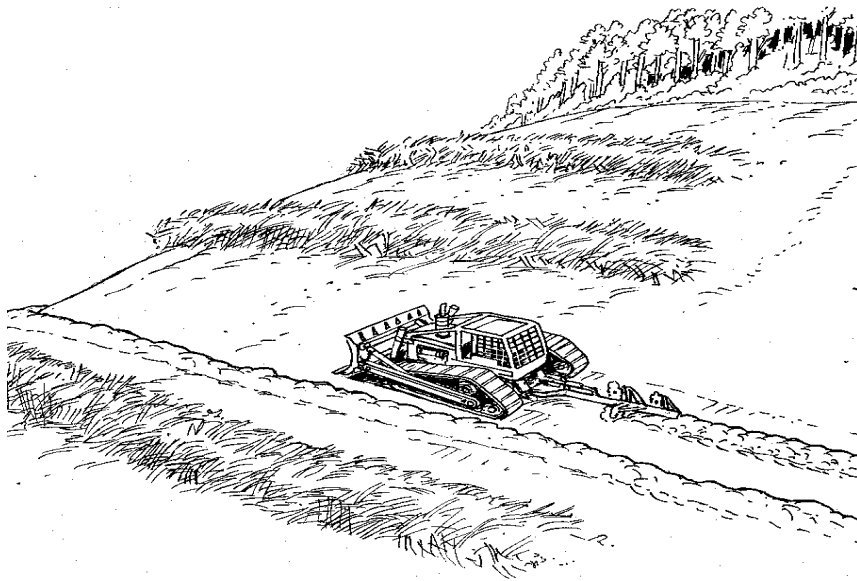

*Figure 9*  
**Contour Ploughing**

## 14.7 CONTOUR PLOUGHING

The contractor and operator **should** ensure that the side slope is within the limits of the machine's safe operational capacity.

## 15 FOREST FIRE FIGHTING

### 15.1 FOREST FIRE MANAGEMENT

#### 15.1.1 Introduction

The forest industry has a protocol designed to minimise the occurrence of accidental fires in forest operations within our forest estate. This is reviewed and updated annually by an industry committee.

The key points in this protocol are:

- a. Registered Fire Weather Observers are required at all forest operations where there is a risk of bush fires occurring accidentally.
- b. Fire weather observations must be recorded at regular intervals during a Fire Permit Period.
- c. Hazardous operations must be suspended when prescribed limits of fire danger occur at local sites.
- d. Additional fire fighting equipment is prescribed for cable harvesting operations.

Refer to Tasmanian Forest Industry Fire Prevention Committee protocols:

Equipment as determined and advised annually by the Tasmanian Forest Industries Fire Prevention Committee is to be on site.

Before each fire season, fire equipment **must** be tested during fire fighting practice.

### 15.2 FIRE RISK FACTORS

The risks involved **must** be assessed before the work begins (*Workplace Health and Safety Regulations 1998 r.17*).

Risk assessment **should** continue throughout the fire-fighting activity, as conditions can change quickly and unpredictably.

This assessment **is to** take account of all factors relating to:

- a. the current and forecast weather, the quantity, dryness, size and arrangement of fuels, and the observed and predicted fire behaviour; and
- b. available resources and equipment, with particular regard to safety of fire-fighters.

### 15.3 BRIEFING

Fire crews **are to** have a briefing, including the results of the risk assessment and safety considerations at the beginning of operations, and then again each day, to ensure that safety is prioritised (*Workplace Health and Safety Act 1995, Sec.9*).

## 15.4 FIRE FIGHTING PLAN

When preparing a fire plan, the accountable person **is to** give consideration to various factors:

- a. The specific skills required of the fire fighters.
- b. All fire fighters **should** be aware of the command structure and the need to ensure the safety of other fire fighters, as well as to comply with all instructions issued by crew leaders.
- c. Communication between all those involved needs to be maintained at all times, during both training exercises and actual fire operations.
- d. Fire crews **should** have a crew leader whose responsibilities **should** include ensuring that all fire fighters are aware of safety procedures and that these are followed.

The safety procedures are summarised by the acronyms WATCH OUT and LACES, which refer to:

|                   |   |
|-------------------|---|
| <b>Weather</b>    | affects the fire – watch for wind changes                             |
| <b>Act</b>        | on both current and expected fire behaviour                           |
| <b>Take care</b>  | conserve energy and drink water often                                 |
| <b>Consult</b>    | with your leader and your crew  |
| <b>Hazards</b>    | are all around you – be aware of fuels, trees and steep slopes        |
| <b>Observe</b>    | fire behaviour and your escape routes                                 |
| <b>Understand</b> | instructions that you are given and ensure that others understand you |
| <b>Think</b>      | clearly and act decisively.   |

**Look out**  
**Anchor points**  
**Communication**  
**Escape routes**  
**Safety zones**

## 15.5 SAFETY FACTORS

Some of the factors that **should** be considered when firefighting are:

- a. machine operators **should** not work alone;
- b. teams of fire fighters **should** ideally include persons who are familiar with the terrain;
- c. roads and tracks in the area **should** be closed if there is danger to persons not involved in the fire-fighting activity; and
- d. sufficient rest periods and an adequate supply of food and beverages **should** be provided to avoid overexertion.

## 15.6 PHYSICAL FITNESS FOR FIRE FIGHTERS

Persons who may be required to undertake fire-fighting duties **should** be assessed for their physical capacity to do the anticipated tasks. Persons **should** not be allocated fire-fighting duties that are beyond either their physical capacity or competence.

## 15.7 COMPETENCY OF FIRE FIGHTERS

All persons in the forest industry who may be required to participate in fire fighting **should** be assessed as competent to safely perform basic fire fighting duties. Competency **should** be assessed on the basis of knowledge and skills in the areas of:

- a. fire fighting organisation, command, structure and reporting;
- b. fire fighting safety;
- c. transport, and the use of four-wheel drive vehicles;
- d. use and maintenance of hand tools;
- e. safety around fire fighting aircraft;
- f. fire behaviour;
- g. fire suppression methods;
- h. communication procedures; and
- i. Workplace First Aid Level 1.

## 15.8 COMPETENCY OF CREW LEADERS AND SUPERVISORS

All persons in the forest industry who may be required to lead or supervise fire fighters **should** be assessed as competent to manage fire fighting operations. In addition to basic fire fighting knowledge and skills, the competency of crew leaders and supervisors **should** be assessed on the basis of:

- a. knowledge of fire weather and topographical effects on fire behaviour;
- b. knowledge and practical application of Incident Administration, including risk management and accident prevention; and
- c. knowledge and practical application of fire fighting strategies and tactics.

## 15.9 PERSONAL PROTECTIVE EQUIPMENT AND CLOTHING FOR FIRE FIGHTERS

Fire fighters **must** be provided with and use (Workplace Health and Safety Regulations 1998 r.58):

- a. overalls or a long-sleeved shirt/trouser combination of a suitable material to provide protection from heat radiation and sparks, in a highly visible colour. Suitable fabrics include cotton, wool, denim or special flame-resistant material. Flammable fabrics or those that might melt, such as nylon or other synthetics (including safety trousers and chaps containing such fabrics) **should not** be worn;
- b. safety helmets suitable for bush fire fighting (refer AS1801 *Occupational protective helmets*);
- c. goggles and smoke masks, when conditions require;
- d. protective gloves which provide protection against cuts, punctures and heat penetration; and
- e. laced or zipped leather steel-capped boots with non-slip soles providing good ankle support.



## 15.10 EQUIPMENT MAINTENANCE

Fire-fighting equipment **must** be inspected for defects before each fire drill and before use in an emergency, and **should** be re-inspected afterwards. It **must** be maintained in accordance with the manufacturer's recommendations (*Workplace Health and Safety Regulations*, r.85).

## 15.11 FIRE FIGHTING EQUIPMENT

Machines **should** be equipped and designed according to the industry protocols and the *Fire Service Act 1979*. In addition, machines operated at night **should** be equipped with at least one forward and one rear light to permit safe working.

## 15.12 FIRE FIGHTING LOOKOUT TOWERS

Safe access to fire lookout towers must be provided and **should** be constructed in accordance with AS 1657 *Fixed platforms, walkways, stairways and ladders – Design, construction and installation* (*Workplace Health and Safety Regulations 1998*, r.29).

Stairways, platforms and railings **should** be inspected annually.

Top access to vertical stairways **should** be closed by trapdoors to prevent accidents caused by falling.

## 15.13 PRESCRIBED BURNING

### 15.13.1 *Aim*

Prescribed burning **should** be thoroughly planned, **should** follow safe working practices, **should** be controlled and **should** have its outcomes monitored and recorded.

### 15.13.2 *Planning*

Planning for burning operations **should** provide for the safe conduct of the operation, based on clearly defined objectives (*Workplace Health and Safety Act* s.9).

Plans **should** minimise the risk of the fire escaping from the planned area.

### 15.13.3 *Briefing*

Before lighting a prescribed burn, the person in charge **must** brief all personnel involved in the operation on the burning plan, their role and safety precautions to be observed.

Details provided **should** include but not be limited to:

- a. specific safety precautions, including arrangements for monitoring the safety of individuals, escape routes and areas of refuge;
- b. objectives of the operation;
- c. a map illustrating the layout of the burn;

- d. lighting pattern;
- e. constraints in the conduct of the burn;
- f. communication plan;
- g. assembly areas; and
- h. specific tasks and responsibilities.

#### 15.13.4 *Lighting*

- a. Before lighting a prescribed burn, the person in charge of the operation **should** be satisfied that the area has been cleared of people and property not directly involved in the operation. They **should** ensure that appropriate measures have been put in place to deal with restricted visibility (likely to be caused by smoke) affecting air, ground or water traffic.
- b. The person in charge of a prescribed fire **is to** ensure that the lighting plan is followed and that the operation is monitored for progress and the safety of all personnel involved.
- c. Prescribed burns **should** be made safe by the prompt and effective suppression of any escapes and thorough mopping up and patrol until declared safe by the person in charge.

Fire fighting requires effective organisation and clear plans that can be carried out rapidly in case of an emergency.

Priorities of fire fighting **should** be to:

- a. protect human life;
- b. prevent damage to dwellings and equipment; and
- c. protect the forest.

### 15.14 FIRE FIGHTING OPERATIONS

- a. All personnel engaged in fire fighting **must** avoid any unnecessary risks to their health and safety (*Workplace Health and Safety Act 1995* s.16).
- b. Fire fighters **are to** be instructed thoroughly about ways of access to and egress from the scene of the fire, particularly the whereabouts of escape routes.
- c. No-one **should** work beyond calling distance from another person.
- d. Fire fighters **should** work at a steady pace and pause to recuperate when necessary. They **should** drink plenty of liquid to replace loss caused by excessive perspiration.
- e. Fire fighters **should** stay within the burnt area at a fire or in firebreaks, on roads, tracks or cleared ground where possible. They **should** avoid being in the unburned area ahead of, above, or on the flank predicted to become the front.
- f. If cut off by the fire, fire fighters **should** try to move into an area that has already burnt.
- g. Burning trees **should** be passed on the uphill side or above the lean. Special caution is needed near overhead electricity lines.

- h. When fire fighting includes the felling and cutting of trees, the safety requirements for harvesting operations of this code **should** apply whenever practicable.
- i. Fire fighters working close to machines **should** do so, where practicable, with the knowledge and agreement of the machine operator.
- j. Fire fighters working close to any aircraft **should** abide by all directions given by the pilot or authorised ground personnel. Fire fighters working in the drop zone of aircraft applying water, foam or retardant **should** follow all safety and work instructions given by the person in charge.
- k. When controlled burning is undertaken, workers **should** adhere to the planned light-up pattern and not deviate from this unless they are instructed to do so. When using a hand burner, the operator **should** be within sight and sound of another person, generally not more than 20m distant.
- l. Vehicles **should** be parked in the direction of the escape route with doors closed, windows up and keys in the ignition, and in such a position that other vehicles may pass in an emergency.

## 16 HUMAN FACTORS

The accountable person **must** make appropriate assessments of hazards that impact on human health (Workplace Health and Safety Regulation 1998 r.17).

Suitable controls for the reduction of risk **must** be implemented (*Workplace Health and Safety Regulations 1998 r.19*).

### 16.1 FATIGUE

Work cycles **are to** be implemented that control the effects of physical and mental fatigue.

Work that involves excessive levels of intensity and duration of physical and mental effort may cause detrimental effects to the employee's health and safety. The accountable person **is to**:

- a. prescribe adequate work breaks;
- b. adopt work practices that reduce body strain and effort;
- c. ensure that work crews are sufficient to do work safely;
- d. reduce fatigue by using adequately designed equipment;
- e. monitor total hours of work.

### 16.2 DEHYDRATION

Work methods and cycles **should** allow for the effects of employee dehydration. Employees **should** take regular work breaks for re-hydration in work environments that have severe climatic and topography conditions, such as:

- a. high air temperature;
- b. high humidity;
- c. low air movement;
- d. exposure to radiant heat either from the sun or from plant; or
- e. the retention of metabolic heat from the use of PPE&C

In hot, humid conditions, re-hydration may require up to 1 litre/hour/person undertaking physically demanding activities.

Employers **must** ensure that a supply of drinking water is available at all workplaces (*Workplace Health and Safety Regulations 1998 r. 116*).

### 16.3 ERGONOMICS

The ergonomic design of work **should** consider the effects of muscular overuse, hours of work, mental activity and heavy manual work.

In order to minimise musculo-skeletal disorders in machine operators, creative work organisation (which may include job rotation and suitable shift schedules) **should** be encouraged.

## 16.4 MENTAL FATIGUE

Mental stress and mental fatigue of operators **should** be assessed and controls implemented, when high production rates are sought and multiple-function machines are in continual use.

Use of the following techniques **should** assist:

- a. regular operator rotation of job function;
- b. ergonomically designed controls and displays;
- c. regular work/rest periods;
- d. correct seating posture; and
- e. support of limbs in static operation positions.

In addition, the fitting of operator's cabin air conditioning may assist.

## 16.5 FITNESS FOR WORK

Employers **should** ensure that employees are medically and physically fit to undertake their work.

All persons in the workplace **must** ensure they are not affected by alcohol or drugs.

## 16.6 NUTRITION

Employers **should** implement suitable meal breaks so as to allow adequate intake of food and drinks for employees.

## 16.7 HEAT STRESS

Severe climatic and environmental conditions may cause the onset of heat stress. As heat stress progresses the mental functions become impaired. Supervisors **should** monitor employees for signs of cramps: flushed face, excessive sweating and cold, pale and clammy skin. Heat stress is more probable with:

- a. high temperatures and exposure to radiant and infra red heat gain;
- b. high humidity;
- c. the wearing of excessive, or impervious clothing; and
- d. excessive physical activity.

## 16.8 VIBRATION

Workers may be exposed to:

- a. whole-body vibration (mobile equipment, rock crushers etc); and/or
- b. hand-arm exposures from portable plant.

The correct ergonomic construction and maintenance of driving seats and vibration damping systems on hand tools and powered portable equipment may limit the exposure. An appropriate assessment **must** be undertaken and suitable controls implemented to minimise the risk from exposure (*Workplace Health and Safety Regulations 1998 r.17*).

## 16.9 ATMOSPHERIC CONTAMINANTS

The person in charge **must** ensure that no person is exposed to hazards from atmospheric contaminants exceeding the exposure concentration standards specified in the *National Exposure Standards (NOHSC 1003(1995)) Exposure Standards For Atmospheric Contaminants in the Occupational Environment.*

## 16.10 ULTRAVIOLET RADIATION (UVR) EXPOSURE

Employers **are to** take all practical precautions to reduce employees' exposure to UVR by:

- a. providing sunscreen;
- b. ensuring suitable clothing is worn by employees exposed to UVR;
- c. providing eye protection devices.

## 16.11 NOISE

Persons required to wear hearing protection are to undergo audiometric testing (*Workplace Health and Safety Regulations 1998 r.111*).

# APPENDIX 1 – GENERAL OBLIGATIONS

## Principles of Risk Management

The principles of the risk management procedure are:

- Spot the hazard
- Assess the risk
- Fix the problem
- Evaluate the results

### Spot the Hazard

There are a number of methods that can be used to identify hazards associated with the workplace. The type of plant used and work processes involved **should** determine the method of identification, a combination of which may give the best results. Methods of identifying hazards include:

- a. Walk-Through Survey – of the workplace using a hazard checklist.
- b. Work Process Evaluation – it is essential to establish a priority for the order in which to analyse:
  - First: select the jobs in which most accidents have occurred and remember – consider **all** accidents – injury, property damage and near misses.
  - Second: consider jobs that have a potential for severe accidents.
  - Third: study newly established jobs carefully or review any change in existing job methods or process changes.
- c. Consultation with Employees – employees are usually the best source of what can go wrong and why, based on their experience. Consultation can take the form of:
  - a. formal discussions during safety committee meetings; or
  - b. informal discussions occurring during on-the-job contact or tool box meetings during work breaks.

In either case, the feedback element is important from a motivational viewpoint. The risk identifier must be kept fully informed of any actions taken.
- d. Manufacturer's Instructions – these are an important source of information about hazards associated with plant.
- e. Specialist Practitioners and Representatives – of industry associations, unions and government bodies may be of assistance in gathering health and safety information relevant to hazards associated with plant.

## Assess the Risk

Once a hazard has been identified a risk assessment **must** be carried out to determine the extent of the risk associated with the hazard. A risk assessment **must** consider the risks to all people potentially affected by the hazard, including non-employees like sub-contractors and members of the public.

A risk assessment **should** determine the following:

- a. the occupations and tasks at risk;
- b. the number of persons at risk;
- c. the probability of a hazard resulting in an injury or disease;
- d. the duration of exposure a person has to the hazard;
- e. the possible consequences (injury, disease, fatality) that may result from a., b., c. and d. above.

The '**Risk Analysis Work Sheet**' contained in this appendix is an example of one technique that can be used and is intended as a rapid guide to identify the level of risk. For instructions in the use of the '**Risk Analysis Work Sheet**' – refer p.92.

Reference, AS/NZS 4360 1999 Risk Management.

## Fix the Problem

Exposure to hazards that may present risks to the health or safety of persons in a workplace must be controlled. This may be accomplished by a number of methods forming what is known as the **hierarchy of control measures**, consisting of six stages described below in decreasing order of priority and effectiveness.

Control measures may be divided into short-term/immediate control measures and long term control measures. The long-term aim **should** always be to **eliminate the hazard at the source**, but whilst attempting to achieve this aim, other short-term actions **should** be used.

In some cases, the control of a hazard may involve the combination of two or more (of the following) control measures:

### a. Elimination

This stage involves removing the hazard from the workplace, e.g. automation of breast-bench operation to remove operator from the area of the throw of the saw.

### b. Substitution

Involves the replacement of a hazard with something that, although still a hazard, is a much lesser hazard – e.g. using water-based paint in place of a solvent-based material.

### c. Isolation

Involves the separation of persons from a hazard by means of relocation of the hazard to a remote location, or by segregating the hazard to prevent personal exposure, e.g. enclosing noisy items of plant in a soundproof enclosure.

### d. Engineering Controls

Minimise the creation of the hazard at its source or by controlling the hazard's potential risks by limiting its effective range, e.g. provision of a correctly placed top-guard to a breast-bench saw or use of a localised dust extraction system.

### e. Administrative Controls

Address the health and safety of persons in the workplace by:

- i. documenting safe work procedures; and
- ii. limiting/adjusting the time or conditions of risk exposure.



**f. Personal Protective Equipment and Clothing**

Involves the use of appropriately designed and properly fitting equipment to be worn by persons to isolate them from hazards present in their surrounding workplaces where other control measures are not practical.

It must be stressed that the use of PPE&C is a '**last ditch effort**' to provide protection from a hazard and **must never** be considered as the primary form of protection.

**Evaluate the Results**

In consultation with employees, review the control measures to be applied in order to determine:

- a. the potential effectiveness of the control measure – i.e. will the risk be reduced if the control measure is applied?
- b. whether the application of a chosen control measure introduces new hazards; and
- c. if the control measure will not introduce any new hazard and it would be effective;

If new hazards, or different systems of work are introduced, a separate risk assessment will need to be carried out on both the work process and the control measure.

It is strongly suggested that control measures are reviewed at least annually.

**Conclusion**

- a. All risk management procedures **should** be repeated at intervals and whenever there is reason to suppose that the results are no longer valid, e.g. new plant or processes are introduced or plant is modified so that it deviates from the original design;
- b. Regulation 18(5) of the *Workplace Health and Safety Regulations 1998* requires that all assessment records be kept for a period of five years after the last revision; and
- c. The requirement in Tasmanian Workplace Safety Legislation is that all risk must be minimised by adoption of the highest ranked control measures practicable.

**Other Legislative Requirements**

Compliance with the Forestry Safety Code (Tasmania) 2007 does not preclude any other person or company from complying with all other relevant laws, including the conditions of licences, permits and other authorities issued.

**EXAMPLE ONLY**

***RISK ANALYSIS WORK SHEET***

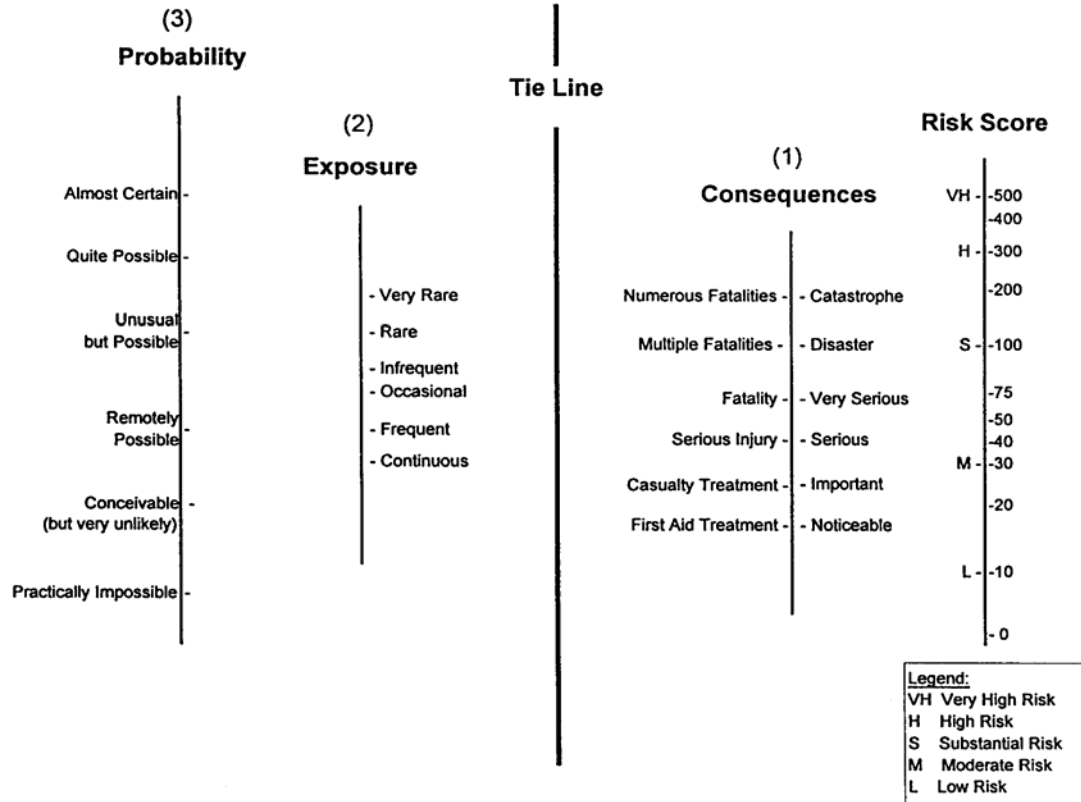

**Identify the hazard:**

---

**Risk Score:**

---

- How to use the Risk Analysis Work Sheet:***
1. How likely is it that an injury will occur from the hazard? Place an "x" on the Probability line according to how likely you think it is that the hazard will cause injury.
  2. How frequent is exposure to the hazard? Place an "x" on the Exposure line according to what the frequency of exposure to the hazard is.
  3. Draw a straight line between the two "x" and mark where it crosses the Tie Line with an "x".
  4. What would the consequence be if an accident did occur from this hazard? What harm could occur or how serious could an injury be? Place an "x" on the Possible Consequences line according to what you think the consequences could be if an injury resulted from the hazard.
  5. Draw a straight line from "x" on the Tie Line and the "x" on the Possible Consequences line and mark where it crosses the Risk line. This is your Assessed Risk.

# EXAMPLE ONLY

## FOREST OPERATIONS SAFETY PLAN

CONTRACTOR: .....

COUPE NUMBER: .....

ASSESSMENT CONDUCTED BY: .....

DATE: .....

HIERARCHY OF CONTROLS:

1. ELIMINATION
2. SUBSTITUTION
3. ISOLATION
4. ENGINEERING CONTROLS
5. ADMINISTRATIVE CONTROLS
6. PPE

| <b>Specific Task/Activity</b>              | <b>Potential Hazard Consequences</b>   | <b>Risk Rating</b><br>High<br>Med<br>Low | <b>Hazard Control Measures</b>  | <b>Risk Rating</b><br>High<br>Med<br>Low |
|--|--|--|---|--|
| <u>Transport of Logs</u>                   | Lake Highway and Poatina Roads are narrow, windy and subject to frost, ice and snow.<br><br>Consequence – vehicle accident | High                                     | <ul style="list-style-type: none"> <li>• No B Double trucks to be used</li> <li>• Conventional trucks only</li> <li>• Appropriate warning signs to be displayed warning of trucks entering onto Great Lakes Highway</li> <li>• Trucks to maintain contact with other trucks via UHF channel 40</li> <li>• Only cart when conditions are suitable (not in icy conditions)</li> </ul> | Low                                      |
| <u>Transport of logs when in isolation</u> | Worker may suffer injury when working in isolation.<br><br>Consequence – injury or death by exposure to elements           | High                                     | <ul style="list-style-type: none"> <li>• Trucks to work in tandem</li> <li>• When not possible a procedure to check driver's welfare every 30 minutes is to be developed (while on landing only)</li> </ul>   | Low                                      |

| <b>Specific Task/Activity</b> | <b>Potential Hazard Consequences</b>   | <b>Risk Rating</b><br>High<br>Med<br>Low | <b>Hazard Control Measures</b>  | <b>Risk Rating</b><br>High<br>Med<br>Low |
|-------------------------------|--|--|---|--|
| <u>Landing Access Road</u>    | Excessively rough road surface.<br>Consequence – injury to driver<br><br>Dead trees along access road.<br>Consequence – injury and truck damage from falling limbs or trees  | High                                     | <ul style="list-style-type: none"> <li>• Top dress road surface with finer gravel to provide smoother surface</li> <li>• Fall all dead and/or defective trees that may fall onto roadway</li> </ul>   | Low                                      |
| <u>Visitor Control</u>        | Visitor will be exposed to risk.<br>Consequence – injury to visitors   | Med                                      | <ul style="list-style-type: none"> <li>• Appropriate signage as per contractor visitor management policy</li> </ul>   | Low                                      |
| <u>Vehicle Parking Areas</u>  | Standing Trees.<br>Consequence – Limbs and trees may fall in windy conditions and due to machinery disturbance (vibration, bumping etc)  | High                                     | <ul style="list-style-type: none"> <li>• Fall all trees that have a distinct lean towards parking area up to 2 tree lengths around parking area</li> <li>• Fall all trees that have the potential to adversely impact on the safety of workers or other persons on site</li> </ul>          | Low                                      |
| <u>Landing Area</u>           | Standing trees.<br>Consequence – Limbs and trees may fall in windy conditions and due to machinery disturbance<br><br>Landing sloping to road.<br>Consequence – Logs sliding towards trucks. Machines tipping towards trucks | High<br><br>Med                          | <ul style="list-style-type: none"> <li>• Fall all trees that have a distinct lean towards the landing / processing area up to 2 tree lengths around the landing / processing area</li> <li>• Bed logs on end of stacks to slope stacks back into landing area and away from road</li> </ul> | Low<br><br>Low                           |

| <b>Specific Task/Activity</b> | <b>Potential Hazard Consequences</b>   | <b>Risk Rating</b><br>High<br>Med<br>Low | <b>Hazard Control Measures</b>   | <b>Risk Rating</b><br>High<br>Med<br>Low |
|-------------------------------|--|--|--|--|
| <u>Tree Falling</u>           | <p>Dead / defective trees.</p> <p>Consequence – Dead / defective trees may fall without warning resulting in serious injury to faller</p> <p>Selective falling.</p> <p>Consequence – Retained stems will make falling more hazardous</p> | <p>High</p> <p>High</p>                  | <ul style="list-style-type: none"> <li>• Falling to be undertaken as per contractor safety management system. Fall all dead / defective trees in progression with falling operation</li> <li>• Faller to fall all trees into space to minimise damage to retained stems (widow makers etc)</li> <li>• At least 2 wedges to be carried by faller, 1 to be aluminium to assist with directional falling</li> <li>• Faller to use extra caution when moving around falling area (very rocky)</li> <li>• Rubber soled boots to be worn for grip on stone</li> <li>• Falling to cease in icy or snowy conditions</li> <li>• Fallers to have UHF communication with other workers on site</li> </ul> | <p>Low</p>                               |
| <u>Snigging of Logs</u>       | <p>Very rocky terrain in conjunction with steep drop offs.</p> <p>Consequence – Machine rollovers</p> <p>Use of tracked machines.</p> <p>Consequence – Will expose operators to a high risk of injury due to travelling over stone.</p>  | <p>High</p> <p>High</p>                  | <ul style="list-style-type: none"> <li>• Operators to use extreme caution and only operate in areas they have assessed as safe to do so</li> <li>• Use of tracked machinery will not be permitted outside of landing area</li> </ul>   | <p>Low</p> <p>Low</p>                    |

| <b>Specific Task/Activity</b> | <b>Potential Hazard Consequences</b>   | <b>Risk Rating</b><br>High<br>Med<br>Low | <b>Hazard Control Measures</b>  | <b>Risk Rating</b><br>High<br>Med<br>Low |
|-------------------------------|--|--|---|--|
| <u>Manual Workers</u>         | Working during extreme weather conditions.<br><br>Consequence – Exposure / hypothermia | High                                     | <ul style="list-style-type: none"> <li>• Provide suitable protective clothing</li> <li>• Provide suitable shelter that will enable drying of clothing and provide shelter from the elements in parking area</li> <li>• When conditions become too severe work is to cease (ie. Heavy snow / ice etc)</li> </ul> | Low                                      |
|                               |  |  |   |  |

Contractor Signature: .....

Other Representative Signature: .....

## APPENDIX 2 – FOREST OPERATIONS SAFETY PLAN (FOS PLAN)

### Forest Operation Safety Plan

The principal **must** develop a Forest Operations Safety Plan (FOS Plan), in conjunction with contractors, which must be evaluated from the results of a hazard identification and risk assessment of the forest coupe in conjunction with the planning and operational requirements of the approved coupe Forest Practices Plan.

The Forest Operations Safety Plan **should** assess:

- a. the topography, climatic and ground conditions of the coupe;
- b. location, access and control of the designated forest operation;
- c. time and production schedules for the operation;
- d. proposed products or other outputs;
- e. safe systems of harvesting/working including reference to appropriate machinery for the task;
- f. establishment of a safe workplace infrastructure, (i.e. roads, bridges, landings);
- g. contingency plan in the event of unsafe or uncontrolled conditions (fire);
- h. communication reception;
- i. identification of hazardous trees;
- j. identification of mining excavations or sinkholes and caves; and
- k. identification and allocation of operational boundaries for multiple contractors on each coupe (e.g. seed collectors).

The hazard control methods are to be discussed with the principal or principal's representative and the contractor, before the start of work on the forest operation.

Any person carrying on work for the principal must be aware of the health and safety requirements of the workplace and the contractor and any person employed or engaged by the contractor must comply with those requirements of the FOS plan.

### Operational Planning Provisions

The Contractor and person in charge of the forest operation **are to** control operational hazard identification and risk management controls for daily operational control of the site.

### Operational Control

The person in charge (bush boss) must ensure that the requirements of the FOS plan are implemented and that operational controls are enforced to ensure that safe systems of work and a safe work environment are maintained.

Hazards identified on the FOS plan and daily operational hazards encountered must be controlled so as to keep employee risk to a reasonable and practicable level.

A safety management system for hazard control must be acceptable to the principal, the contractors and the forest operation person in charge to enable variance from initial planning where risk to employees is identified as unacceptable.

## APPENDIX 3 – TFITB INDUSTRY COMPETENCY STANDARDS

### Machine Familiarisation

#### Dozer (plus machine familiarisation competencies)

- Dozer logging
- Dozer land clearing
- Dozer earthworks
- Dozer roading

#### Excavator (plus machine familiarisation competencies)

- Excavator earthworks
- Excavator harvesting
- Excavator land clearing
- Excavator roading
- Excavator mill work only
- Excavator log loading

#### Fulghum log handler (plus Machine familiarisation competencies)

#### Loader (plus machine familiarisation competencies)

- Wheel loader
- Loader earthworks
- Loader mill work
- Front end loader

#### Knuckleboom Loader (plus machine familiarisation competencies)

#### Skidder (plus machine familiarisation competencies)

#### Traxcavator (plus machine familiarisation competencies)

#### Mechanical Harvesting (plus machine familiarisation competencies)

- Mechanical feller/native forests
- Mechanical feller/plantation
- Processor
- Forwarder

#### **Cable logging**

- Chokerman
- Spotter
- Chaser
- Tree Climber
- Rigging Slinger
- Hook Tender
- Yarder
- Cable Logger (Advanced)

#### **Chainsaw** (Sawmill)

#### Tree Feller (plus chainsaw competencies)

- Nat 1  
Eucalypt oldgrowth
- Nat 2  
Eucalypt regrowth
- Nat 3  
Mixed Species
- Nat 4  
Non-commercial felling
- Pltn 5  
Plantation clearfelling
- Pltn 6  
Plantation thinning
- Pltn 7  
Plantation  
non-commercial thinning

**For a current list of up to date standards, please contact the Tasmanian Forest Industries Training Board.**



## 17 DEFINITIONS

**Approved** – means approved by the Director of Industry Safety.

**Approved course of training** – means a course conducted by a training authority or an approved person.

**Assessment** – means an assessment conducted by a training authority or an approved person.

**AS – Australian Standard** – a reference to an Australian Standard, described by numerals and a title, means the standard of the Standards Association of Australia as so described and for the time being in force, or any standard of the Association issued in amendment or replacement of that standard.

**AS/NZS – Australian/New Zealand Standard** – a reference to an Australian/New Zealand Standard, described by numerals and a title, means the standard of the Standards Association of Australia as so described and for the time being in force, or any standard of the Association issued in amendment or replacement of that standard.

**Babbling** – means the termination of steel wire ropes in accordance with Australian Standard 2759 *Steel wire rope – Application guide*.

**Cab shielding** – means a protective barrier located on a log-carrying vehicle between the end of the logs and the operator's cabin.

**Cable harvesting** – means any yarding system employing a stationary machine with powered drum(s), spars or towers, blocks, wire rope and butt rigging to yard logs from the felling site to the landing.

**Chemicals** – includes the range of fertilisers, insecticides, fungicides and herbicides or other substances covered under the *Dangerous Goods Act 1998* which may be used in forest operations.

**Clear felling** – means the felling and removal of all or nearly all commercial trees from a specific area in one operation.

**Close supervision:** means a supervisor will at all times have vision of the operator and be able to give voice directives to the trainee.

**Competent person** – means a person with sufficient knowledge and skills acquired through qualification, training or experience to perform the task to which the term relates.

**Contract of service** – means:

- a contract under which a natural person is employed by another person; and
- a contract of apprenticeship; and
- a contract or agreement under which a natural person receives training in an occupation, a trade or a vocation from an employer.

**Contractor** – means a person engaged by any person (otherwise than as an employee) to perform work for gain or reward.

**Coupe** – means an area of forest of variable size, shape and orientation, on which harvesting takes place, usually to be harvested and regenerated over one or two years.

**Cyclical Loading** – means frequent operational loadings to machine components, which may induce material stresses likely to cause fatigue failure.

**Dangerous Goods** – means:

- a) a substance or article prescribed as dangerous goods in the Dangerous Goods Act 1998;
- b) a substance or article determined by a competent authority in accordance with the *Dangerous Goods Regulations 1998*.

**Driving trees** – means felling a tree into one or more trees to bring those trees down.

**Employee** – means a natural person who is employed under a contract of service and, in relation to any educational or other training establishment, includes any natural person who, as a student, uses hazardous substances or plant in that establishment.

**Employer** – means a person by whom an employee is employed under a contract of service.

**Eucalypt Tree Farm** – means Eucalyptus species forests established using seedlings planted at regular spacing.

**Feller (faller)** – means the person who cuts or chops a standing tree or part of a standing tree to bring down that tree.

**Fell (felling)** – means to cut, chop, push or pull down a standing tree or part of a standing tree, or bring down a tree using explosives.

**Fire suppression** – means all activity involved with the prevention and suppression of wildfire.

**Forest operation** – means work done for hire or reward in the forest industry in:

- a. the formation, development and regeneration of forests; and
- b. the obtaining of forest produce; and
- c. the loading, transporting and unloading of forest produce; and
- d. post operative assessment
- e. clearing, fencing, trenching or draining; and
- f. the establishment of, and the major upgrade of roads or tracks.

**Forest Operation Safety Plan** – means an operational plan that contains a risk assessment and hazard assessment that a person in charge has carried out before or during work on any forest operation in accordance with 3.1.

**Forest Practices Plan** – means a plan for forest operations as specified in section 18 of the *Forest Practices Act 1985*.

**Hazard** – any reasonably foreseeable situation or event that may give rise to the potential of injury or illness to any person.

**Hazardous substance**

- a. is listed on the NOHSC *List of Designated Hazardous Substances* or
- b. *has been classified as a hazardous substance by the manufacturer or importer, in accordance with the National Commission's Approved Criteria for Classifying Hazardous Substances* (NOHSC:1008(1994))2 (the approved criteria).

### **Hazardous trees –**

- a. all trees with widow makers within one tree length of the landing;
- b. trees containing or affected by any of the following:
  - excessive drainage problems as a result of snigging;
  - exposed root system;
  - root, trunk or stem damage;
  - exposure to vibration; or
  - potential for impact by machinery or snigged log.
- c. trees with shallow root systems located in unstable ground conditions;
- d. dead trees;
- e. trees with root systems exposed to excessive drainage causing erosion or soft soil conditions;
- f. trees regularly exposed to machinery vibration;
- g. all trees with an obvious lean towards the landing;
- h. trees exposed to prevailing wind. 'Exposed' means where an adjacent tree, upwind of prevailing wind direction, has been removed or the tree closest to the landing is 10% higher than surrounding trees and is located up-wind of the log landing. If the wind changes, trees in other orientations may come within this classification;
- i. trees subject to excavation on the landing site within less than 5 trunk diameters and to a depth greater than 1 trunk diameter. From this point benching may only occur at 45 degrees. Should erosion occur, the tree **is to** be felled;
- j. trees causing obstruction to snig tracks or landing access; and

**Industry** – means any industry, trade, business, undertaking, profession, calling, function, process or work in which persons are employed or engaged and includes the use of plant in an educational establishment.

**Is to/are to** – If a clause says a person **is to**, or persons **are to**, do something, then you are being instructed to do it, but in these situations you have a choice. This situation is unique to codes of practice approved under s.22 of the Act. The code provides flexibility in this instance to allow practical and innovative solutions to be developed in the workplace. When an alternative solution is developed to that contained in the code, you must conduct a risk assessment to determine if what you have done is **equal to or better than** the instruction, and you could be required to prove it.

**Logs** – means tree segments suitable for subsequent processing into sawn timber, pulpwood, chip wood or other wood products.

**Log landing** – includes log dump, skidway, log yard or other area used for the cutting up, debarking, measuring or sawing of logs.

**Manual felling** – the felling of a tree by a method that requires the faller to stand at the base of a tree to execute the tree felling operation.

**Must** – means the requirement is contained within the ***Workplace Health and Safety Act 1995*** or the ***Workplace Health and Safety Regulations 1998***. This means that you have no other option than to do what the clause requires.

**National Load Restraint Guide** – A reference to the load restraint guide means a reference to the Federal Office of Road Safety National Road Transport Commission Load Restraint Guide – Guidelines for the safe carriage of loads on road vehicles.

**Person in charge** – means the person present at the workplace or his/her nominee responsible for the direction and control of the forest operation.

**Plant** – means any machinery, equipment, scaffolding, amusement structure, appliance, implement or tool and any component or fitting of any of those things.

**Practicable** – means having regard to:

- a. The severity of the hazard or risk under assessment;
- b. The state of knowledge about that hazard or risk and any ways of removing or mitigating the hazard or risk;
- c. The availability and suitability of ways to remove or mitigate that hazard or risk;
- d. The cost of removing or mitigating that hazard or risk.

**Prescribed authority** – means the Standards Association of Australia, the British Standards Institution, the International Organisation for Standardisation, the American National Standards Institute, Standards New Zealand, the National Occupational Health and Safety Commission or any other similar authority prescribed in the *Workplace Health and Safety Regulations 1998*.

**Prescribed burn** – means a planned fire which conforms to predetermined parameters and is lit for the purpose of achieving a land management objective.

**Principal** – means a person who engages any person (otherwise than as an employee) to perform work for gain or reward.

**Quarry** – means an area of land where earth, gravel, rock or sand is extracted for use on roads in forest operations.

**Regeneration** – means the renewal of a tree crop arising from planting or from silvicultural practices on a site.

**Registered Plant Inspector** – Means a person registered as a plant inspector under r. 46 of the *Workplace Health and Safety Regulations 1998*.

**Risk** – the likelihood of an unplanned, or uncontrolled event occurring.

**Road** – means a path or way with specially prepared surface, used by vehicles or pedestrians.

**Self-employed person** – means a natural person who works for gain or reward otherwise than as an employee.

**Should** – means ‘**should** statements’ will apply unless there are alternative methods that will achieve the minimum standard of this Code and acceptable health and safety outcomes. This Code provides the minimum standards that are to be achieved.

**Snig** – means to pull a log by wire, rope chain or grapple.

**Snig track** – means a track along which logs are pulled from the felling point to a nearby landing.

**Substance** – means any natural or artificial substance, whether in solid or liquid form or in the form of a gas or vapour.

**Thinning** – means the felling and removal of part of the forest crop.

**Tool** – means a manually operated tool or a power operated tool.

**Track** – means a rough path or way used by vehicles or pedestrians.

**Under-storey** – means that part of forest vegetation growing below the forest canopy;

**Visitor** – means any person who is not directly employed or engaged at the workplace and enters the workplace;

**Widow makers** – means a limb or branch of a tree, which may unexpectedly dislodge from a tree and present a high risk of injuring a person.

**Will** – means to be construed as being mandatory in achieving the standards of this Code in respect to achieving an acceptable standard of health and safety.

**Workplace** – means any premises or place (including any mine, aircraft, vessel or vehicle) where an employee, contractor or self-employed person is employed or engaged in industry:

## 17.1 REFERENCES

### **Legislation**

*Dangerous Goods Act 1998*

*Dangerous Goods Regulations 1998*

*Firearms Act 1996*

Forest Practices Code

*Fire Service Act 1979*

*Workplace Health and Safety Act 1995*

*Workplace Health and Safety Regulations 1998*

### **Australian Standards**

Australian Standard 1163 - *Structural steel hollow sections*

Australian Standard/New Zealand Standard 1270 – *Acoustics – Hearing protectors*

Australian Standard 1319 – *Safety signs for the occupational environment*

Australian Standard/New Zealand Standard 1336 – *Recommended practices for occupational eye protection*

Australian Standard 1418.5 - *Mobile and vehicle loading cranes*

Australian Standard 1418.10 - *Elevating Work Platforms*

Australian Standard 1554 – *Structural steel welding code*

Australian Standard 1657 - *Fixed platforms, walkways, stairways and ladders – Design, construction and installation*

Australian Standard/New Zealand Standard 1715 – *Selection, use and maintenance of respiratory protective devices*

Australian Standard/New Zealand Standard 1716 – *Respiratory protective devices*

Australian Standard 1742 - *Manual of uniform traffic control devices. Part 2: Traffic control devices for general use*

Australian Standard/New Zealand Standard 1800 – *Occupational protective helmets – Selection, care and use*

Australian Standard/New Zealand Standard 1801 – *Occupational protective helmets*

Australian Standard 1851 - *Maintenance of fire protection equipment*

Australian Standard/New Zealand Standard 1891 - Industrial fall-arrest systems and devices, Part 1 Safety belts and harnesses

Australian Standard/New Zealand Standard 1892 - Portable Ladders

Australian Standard/New Zealand Standard 1906 – Retroreflective materials and devices for road traffic control purposes

Australian Standard/New Zealand Standard 2153 – Tractors and machinery for agriculture and forestry – Technical means for ensuring safety

Australian Standard 2187 - Explosives – Storage, transport and use

Australian Standard 2187.2 - Use of explosives

Australian Standard/New Zealand Standard 2161 – Occupational protective gloves

Australian Standard/New Zealand Standard 2210 – Occupational protective footwear

Australian Standard 2294 – Earth moving machinery – Protective structures

Australian Standard 2550.10 - Elevating Work Platforms

Australian Standard 2726 – Chainsaws – Safety requirements

Australian Standard 2726.2 – Chainsaws – Safety requirements Part 2: Chainsaws for tree service

Australian Standard 2727 – Chainsaws – Guide to safe working practices

Australian Standard 2759 – Steel wire rope – Application guide

Australian Standard 2980 – Qualification of arc-welders for welding of steels

Australian Standard 3574 – SAA Forest safety code

Australian Standard 3575- Clearing saws, brushcutters and grass trimmers – Safety requirements

Australian Standard 3576 - Clearing saws, brushcutters and grass trimmers- Guide to safe work practices

Australian Standard AS 4100 - Steel Structures

Australian Standard/New Zealand Standard 4024 – Safeguarding of machinery

Australian Standard/New Zealand Standard 4043.1 - Motor vehicles – Cargo barriers for occupant protection

Australian Standard/New Zealand Standard 4360, 1999 - Risk Management

Australian Standard/New Zealand Standard 4453 – Leg protection for users of hand-held chainsaws

Australian Standard/New Zealand Standard 4602 – High visibility safety garments

Australia New Zealand Standard 4801, 2000 - Occupational Health and Safety Management System – Specification with guidance for use

Australia New Zealand Standard 4804, 1997 - Occupational Health and Safety Management System – Guidelines

### **International Standards**

British Standard/New Zealand Standard 302, Part 5 - Specification for ropes for hauling purposes

International Standard Organization 8082 – Machinery for forestry – Roll over protective structures

International Standards Organization 8083 – Machinery for forestry – Falling object protective structures

International Standard Organization 8084 – Machinery for forestry – Operator protective structures

International Standard Organization 10968 – Earth moving machinery – Operator controls

DIN 7948/EN 12492.

### **Reference Texts**

*Australian Explosives Code 2000*

*Chainsaw Operators Manual, State Forests NSW*

*Code of Practice for Power-Operated Elevating Work Platforms*

Environment Protection, Planning and Analytical Services Division, Hobart, Quarry Code of Practice 1999, ISBN 0 124 662294

Forestry Tasmania - Forest Industry, Fire Suppression Protocol 1997/1998,

Forestry Tasmania - Forest Industry, Fire Prevention at Timber Harvesting Operations 2000/2001

National Transport Commission & Roads & Traffic Authority NSW - Load Restraint Guide – Guidelines and performance standards for the Safe Carriage of Loads on Road Vehicles

Office of the Tasmanian Electricity Regulator. Distribution Powerline Clearance – Vegetation Draft Code of Practice, 2000

Transend - Electrical Safety Code

West One Services - Shotfirer Training Manual

Tasmanian Forest Industries Training Board - Tasmanian Cable Harvesting Code



National Exposure Standards (NOHSC 1003(1995)) - *Exposure Standards For Atmospheric Contaminants in the Occupational Environment*

National Occupational Health and Safety Commission's *Approved Criteria for Classifying Hazardous Substances* (NOHSC:1008(1994)) 2 (the approved criteria)

*Traffic Control at Work Sites Code of Practice*

### ***Workplace Standards Tasmania***

*Reference Safety Guides*

Workplace Safe Bulletin No. 33 – *Protective Canopies for Excavator Type Machines used in Forest Operations*

### ***Reference Internet Site Addresses***

Forest and Forest Products Employment Skills Company Ltd:

<http://www.fafpesc.com.au>

Forestry Tasmania <http://www.forestrytas.com.au/>

Tasmanian Forest Industries Training Board

Workplace Standards Tasmania [www.dier.tas.gov.au](http://www.dier.tas.gov.au)

Transend <http://www.transend.com.au/>

Aurora Energy <http://www.auroraenergy.com.au/>

## 17.2 CODE DEVELOPMENT MEMBERS

Members of the Safety Standards Committee of the Tasmanian Forest Industries Training Board.